

**STATUTORY INSTRUMENTS SUPPLEMENT**

*to The Uganda Gazette No. 50, Volume CXV, dated 15th August, 2022*

Printed by UPPC, Entebbe, by Order of the Government.

---

---

**S T A T U T O R Y I N S T R U M E N T S**

**2022 No. 94.**

**THE CIVIL AVIATION (AERODROMES) REGULATIONS, 2022**

**ARRANGEMENT OF REGULATIONS**

*Regulation*

**PART I—PRELIMINARY**

1. Title
2. Application
3. Interpretation
4. Certification of aerodromes
5. Use of common reference systems
6. Categories of aerodromes

**PART II—CONSTRUCTION OF AERODROMES**

7. Requirements for application for aerodrome construction permit
8. Issuance of aerodrome construction permit
9. Design and construction of aerodrome
10. Aerodrome master plan
11. Requirements for aerodrome design
12. Aerodrome reference code

**PART III—LICENSING OF AERODROMES**

13. Application of this Part
14. Application for licence

## *Regulation*

15. Conditions for issuance of licence
16. Issuance of licence
17. Breach of conditions of licence and non-conformity with licensing requirements
18. Specifications of aerodrome licence
19. Validity of licence
20. Renewal of licence
21. Amendment of licence
22. Interim aerodrome licence
23. Suspension of licence
24. Cancellation of licence
25. Surrender of licence
26. Charges and fines at licensed aerodromes
27. Licence register
28. Notification and furnishing of information

### PART IV—CERTIFICATION OF AERODROMES

29. Application of this Part
30. Application for certificate
31. Conditions for issuance of certificate
32. Breach of conditions of certificate and non-conformance with certification requirements
33. Aerodrome certificate
34. Issuance of aerodrome certificate
35. Validity of aerodrome certificate
36. Renewal of aerodrome certificate
37. Amendment of aerodrome certificate
38. Interim aerodrome certificate
39. Suspension of aerodrome certificate
40. Cancellation of aerodrome certificate
41. Surrender of aerodrome certificate
42. Charges and fines at certificated aerodromes
43. Register of aerodrome certificates

### PART V—OBLIGATIONS OF AERODROME OPERATOR

44. Compliance with regulations and conditions
45. Competence of operational and maintenance personnel

## *Regulation*

46. Aerodrome operations and maintenance
47. Safety management system
48. Internal safety audits and safety reporting of aerodrome operator
49. Storage of inflammable and other dangerous goods
50. Safety measures against fire
51. Access to and operations within restricted areas
52. Entry into or exit from restricted areas of aerodrome
53. Test-running of aircraft engine
54. Removal of obstructions from aerodrome movement surface
55. Maintenance of environment management programme
56. Protection of navigation aids
57. Responsibilities of aerodrome operator
58. Inspection of aerodromes and unhindered access by inspectors of authority
59. Notifying and reporting
60. Aerodrome movement area inspections
61. Special inspections
62. Warning notices

### PART VI—AERODROME MANUAL

63. Requirements for aerodrome manual
64. Information to be included in aerodrome manual
65. Amendment of aerodrome manual

### PART VII—AERODROME DATA

66. Aeronautical data
67. Aerodrome reference point
68. Aerodrome and runway elevation
69. Aerodrome reference temperature
70. Aerodrome dimensions and related information
71. Strength of pavements
72. Strength of pavements
73. Pre-flight altimeter check location
74. Declared distances
75. Condition of movement area and related facilities
76. Runway surface condition for use in runway condition report

*Regulation*

77. Disabled aircraft removal
78. Information on rescue and fire-fighting
79. Visual approach slope indicator system
80. Coordination between aeronautical information services and aerodrome authorities

PART VIII—AERODROME PHYSICAL CHARACTERISTICS

81. Conditions for operating aerodrome
82. Standards for physical characteristics of aerodrome
83. Number and orientation of runways
84. Choice of maximum permissible cross-wind components
85. Data to be used for calculation of runway usability factor
86. Location of threshold
87. Determination of actual length of runway
88. Determination of width of runway
89. Determination of minimum distance between parallel runways
90. Slopes on runways
91. Strength of runways
92. Surface of runways
93. Runway shoulders
94. Runway turn pads
95. Runway strips
96. Slopes on runway strips
97. Strength of runway strips
98. Runway end safety area
99. Clearways
100. Stopways
101. Radio altimeter operating area
102. Taxiways
103. Rapid exit taxiways
104. Taxiways on bridges
105. Taxiway shoulders
106. Taxiway strips
107. Holding bays, runway holding positions, intermediate holding positions and road holding positions
108. Aprons
109. Isolated aircraft parking position

*Regulation*

PART IX—OBSTACLE RESTRICTION AND REMOVAL

110. Establishment of obstacle limitation surfaces
111. Obstacle limitation surfaces
112. Outer horizontal surface
113. Conical surface
114. Inner horizontal surface
115. Approach surface
116. Inner approach surface
117. Transitional surface
118. Inner transitional surface
119. Balked landing surface
120. Take-off climb surface
121. Obstacle limitation requirements
122. Obstacle limitation requirements for non-instrument runways
123. Obstacle limitation requirements for non-precision approach runway
124. Obstacle limitation requirements for precision approach runways
125. Obstacle limitation requirements for runways meant for take-off
126. Objects outside obstacle limitation surfaces and other objects
127. Authorisation to construct within vicinity of aerodrome
128. Erection of obstacle
129. Removal of obstacle

PART X—VISUAL AIDS FOR NAVIGATION

130. Wind direction indicators
131. Landing direction indicator
132. Signalling lamp
133. Signal panel and signal area
134. Markings
135. Interruption of runway markings
136. Runway designation marking
137. Runway center line marking

## *Regulation*

138. Threshold marking
139. Aiming point marking
140. Touchdown zone marking
141. Runway side stripe marking
142. Taxiway center line marking
143. Runway turn pad marking
144. Runway-holding position marking
145. Intermediate holding position marking
146. VOR aerodrome checkpoint marking
147. Aircraft stand markings
148. Apron safety lines
149. Road-holding position marking
150. Mandatory instruction marking
151. Information marking
152. Establishment of aeronautical ground lights
153. Lights which may endanger safety of aircraft
154. Laser emissions which may endanger safety of aircraft
155. Lights which may cause confusion
156. Elevated approach lights
157. Elevated lights
158. Surface lights
159. Light intensity and control
160. Emergency lighting
161. Aeronautical beacons
162. Aerodrome beacon
163. Identification beacon
164. Approach lighting system
165. Simple approach lighting system
166. Precision approach category I lighting system
167. Precision approach category II and III lighting system
168. Visual approach slope indicator systems
169. PAPI and APAPI
170. Approach slope and elevation setting of light units

## *Regulation*

171. Obstacle Protection Surface for PAPI and APAPI
172. Circling guidance lights
173. Runway threshold identification lights
174. Runway lead-in lighting systems
175. Runway edge lights
176. Runway threshold and wing bar lights
177. Runway end lights
178. Runway center line lights
179. Runway touchdown zone lights
180. Simple Touchdown Zone lights
181. Rapid exit taxiway indicator lights
182. Stopway lights
183. Taxiway center line lights
184. Taxiway center line lights on taxiways
185. Taxiway center line lights on rapid exit taxiways
186. Taxiway center line lights on other exit taxiways
187. Taxiway center line lights on runways
188. Taxiway edge lights
189. Runway turn pad lights
190. Stop bars
191. No entry bar
192. Intermediate holding position lights
193. Runway guard lights
194. Apron floodlighting
195. Visual docking guidance system
196. Azimuth guidance unit in VDGS
197. Stopping position indicator in VDGS
198. Advanced Visual Docking Guidance System
199. Aircraft Stand manoeuvring guidance lights
200. Road-holding position light
201. Runway status lights
202. Signs
203. Mandatory instruction signs

*Regulation*

- 204. Information signs
- 205. VOR aerodrome checkpoint sign
- 206. Aerodrome identification signs
- 207. Aircraft stand identification signs
- 208. Road-holding position sign
- 209. Markers
- 210. Unpaved runways edge markers
- 211. Stop way edge markers
- 212. Taxiway edge markers
- 213. Taxiway center line markers
- 214. Unpaved taxiway edge markers
- 215. Boundary markers

PART XI—VISUAL AIDS FOR DENOTING OBSTACLES

- 216. Provision of visual aids for denoting obstacles
- 217. Marking and lighting of objects within lateral boundaries of obstacle limitation surfaces
- 218. Marking and lighting of objects outside lateral boundaries of obstacle limitation surfaces
- 219. Marking or lighting of objects
- 220. Marking and lighting of mobile objects
- 221. Marking of fixed objects
- 222. Lighting of fixed objects
- 223. Lighting of objects with height less than 45 m above ground level
- 224. Lighting of objects with a height 45m or more to a height less than 150 m above ground level
- 225. Lighting of objects with a height 150m or more above ground level
- 226. Marking of wind turbines
- 227. Lighting of wind turbines
- 228. Marking of overhead wires, cables, etc., and supporting towers
- 229. Lighting of overhead wires, cables, and supporting towers



*Regulation*

PART XII— VISUAL AIDS FOR DENOTING  
RESTRICTED USE AREAS

- 230. Marking of restricted use areas
- 231. Marking and lighting of closed runways and taxiways or parts of the runway and taxiways
- 232. Marking of non-load-bearing surfaces
- 233. Marking of pre-threshold areas
- 234. Marking and lighting of unserviceable areas

PART XIII—ELECTRICAL SYSTEMS

- 235. Application of this Part
- 236. Electrical power supply systems for air navigation services facilities
- 237. Electrical System design
- 238. Monitoring of electrical systems

PART XIV—AERODROME OPERATIONAL SERVICES,  
EQUIPMENT, INSTALLATIONS AND FACILITIES

- 239. Immigration, customs and excise aerodromes
- 240. Supply of aviation fuel to aircraft
- 241. Aerodrome emergency planning
- 242. Emergency planning committee
- 243. Emergency operation center and command post
- 244. Aerodrome emergency exercises
- 245. Emergencies in difficult environment
- 246. Establishment of aerodrome rescue and fire-fighting services
- 247. Determination of aerodrome rescue and fire-fighting category
- 248. Level of protection for rescue and fire-fighting services
- 249. Extinguishing agents
- 250. Provision of reserve supplies of water and foam for fire-fighting vehicles
- 251. Provision of rescue equipment

## *Regulation*

- 252. Response time for rescue and fire-fighting services
- 253. Establishment of emergency access roads
- 254. Rescue and fire- fighting service stations
- 255. Provision of communication and alerting systems for rescue and fire-fighting services
- 256. Minimum number of rescue and fire-fighting vehicles
- 257. Requirements for rescue and fire-fighting personnel
- 258. Removal of disabled aircraft
- 259. Apron management service
- 260. Ground servicing of aircraft
- 261. Aerodrome vehicle operation
- 262. Surface movement guidance and control systems
- 263. Siting of equipment and installations on operational areas
- 264. Fencing of aerodromes and installations
- 265. Maintenance of safety inspection programme
- 266. Maintenance of fire prevention programme
- 267. Access of ground vehicles and personnel to aerodrome movement area
- 268. Operation of aircraft exceeding certified characteristics of aerodrome
- 269. Autonomous runway incursion warning system

## PART XV—WILDLIFE HAZARD MANAGEMENT

- 270. Application of Part
- 271. Wildlife hazard management
- 272. Wildlife strike hazard reduction at aerodrome
- 273. National committee on wildlife hazard management
- 274. Responsibilities of national committee on wildlife hazard management
- 275. Composition of national committee on wildlife hazard management
- 276. Animals not allowed in restricted areas of aerodrome

PART XVI—AERODROME MAINTENANCE

- 277. Maintenance programme
- 278. Maintenance of pavements and adjacent areas
- 279. Removal of contaminants
- 280. Runway pavement overlays
- 281. Maintenance of visual aids
- 282. Construction or maintenance activity during low visibility operations
- 283. Works at aerodromes

PART XVII—EXEMPTIONS

- 284. Application for exemption
- 285. Initial review by authority
- 286. Evaluation of application for exemption
- 287. Grant or refusal of exemption
- 288. Control or review of exemptions

PART XVIII—GENERAL PROVISIONS

- 289. Change of name of licence or certificate holder
- 290. Change of address by licence or certificate holder
- 291. Use and retention of licences, certificates, approvals and records
- 292. Replacement of documents
- 293. Aeronautical user charges
- 294. Conditions for operating aerodrome
- 295. Lighting of en-route obstacles
- 296. Land use in vicinity of aerodrome
- 297. Aeronautical study
- 298. Deviations from regulations
- 299. Safety inspections and audits
- 300. Obligation to insure aerodrome

*Regulation*

301. Acts prohibited on an aerodrome

**PART XIX—OFFENCES AND PENALTIES**

302. Contravention of Regulations  
303. Offences and penalties

**PART XX—REVOCATION, SAVINGS AND TRANSITIONAL**

304. Revocation of S.I. No. 17 of 2019  
305. Savings and Transitional

**SCHEDULES**

- SCHEDULE 1 — PARTICULARS TO BE INCLUDED IN AN  
AERODROME MANUAL FOR AERODROMES IN  
CATEGORY **A, B AND C**
- SCHEDULE 2 — SHIELDING OF OBSTACLES
- SCHEDULE 3 — COLOURS FOR AERONAUTICAL GROUND  
LIGHTS, MARKINGS, SIGNS AND PANELS
- SCHEDULE 4 — AERONAUTICAL GROUND LIGHT  
CHARACTERISTICS
- SCHEDULE 5 — MANDATORY INSTRUCTION MARKINGS  
AND INFORMATION MARKINGS
- SCHEDULE 6 — REQUIREMENTS CONCERNING DESIGN OF  
TAXIING GUIDANCE SIGNS
- SCHEDULE 7 — LOCATION OF LIGHTS ON OBSTACLES
- SCHEDULE 8 — GUIDANCE MATERIAL SUPPLEMENTARY TO  
THESE REGULATIONS
- SCHEDULE 9 — OBSTACLE LIMITATION SURFACES

# S T A T U T O R Y I N S T R U M E N T S

2022 No. 94.

## **The Civil Aviation (Aerodromes) Regulations, 2022**

*(Under section 61 of the Civil Aviation Authority Act, Cap. 354)*

**IN EXERCISE** of the powers conferred upon the Minister by sections 34 (2) and 61 of the Civil Aviation Authority Act, and on the recommendation of the Uganda Civil Aviation Authority, these Regulations are made this 12th day of August, 2022.

### PART I—PRELIMINARY

#### **1. Title**

These Regulations may be cited as the Civil Aviation (Aerodromes) Regulations, 2022.

#### **2. Application**

(1) These Regulations apply to all civil aerodromes in Uganda except where the authority specifies otherwise.

(2) Wherever a colour is referred to in these Regulations, the specifications prescribed in Schedule 3 to these Regulations shall apply for that colour.

(3) The specifications of Part VIII of these Regulations, shall apply to land aerodromes only.

(4) The specifications in these Regulations shall apply where appropriate, to heliports but shall not apply to stolports.

#### **3. Interpretation**

In these Regulations unless the context otherwise requires—

“accident” means an occurrence associated with the operation of an aircraft which, in the case of a manned

aircraft, takes place between the time a person boards the aircraft with the intention of flight until such time as all such persons have disembarked, or in the case of an unmanned aircraft, takes place between the time the aircraft is ready to move with the purpose of flight until such time as it comes to rest at the end of the flight and the primary propulsion system is shut down, in which—

- (a) a person is fatally or seriously injured as a result of—
  - (i) being in the aircraft;
  - (ii) direct contact with any part of the aircraft, including parts which have become detached from the aircraft; or
  - (iii) direct exposure to jet blast,

except when the injuries are from natural causes, self-inflicted or inflicted by other persons, or when the injuries are to stowaways hiding outside the areas normally available to the passengers and crew; or

- (b) the aircraft sustains damage or structural failure which—
  - (i) adversely affects the structural strength, performance or flight characteristics of the aircraft; and
  - (ii) would normally require major repair or replacement of the affected component,

except for engine failure or damage, when the damage is limited to a single engine including its cowlings or accessories, to propellers, wing tips, antennas, probes, vanes, tyres, brakes, wheels, fairings, panels, landing gear doors, windscreens, the aircraft skin such as small dents or puncture holes, or for minor damages to main rotor blades, tail rotor blades, landing gear, and those

resulting from hail or bird strike including holes in the radome; or

(c) the aircraft is missing or is completely inaccessible;

“ACN” means the Aircraft Classification Number;

“Act” means the Civil Aviation Authority Act, Cap. 354;

“aerodrome” means a defined area on land or water, including any buildings, installations and equipment, intended to be used either wholly or in part for the arrival, departure and surface movement of aircraft;

“aerodrome beacon” means an aeronautical beacon used to indicate the location of an aerodrome from the air;

“aerodrome certificate” means a certificate issued by the authority under Part IV of these Regulations for the operation of an aerodrome;

“aerodrome elevation” means the elevation of the highest point of the landing area;

“aerodrome facilities and equipment” means facilities and equipment, inside or outside the boundaries of an aerodrome that are constructed or installed and maintained for the arrival, departure and surface movement of an aircraft;

“aerodrome identification sign” means a sign placed on an aerodrome to aid in identifying the aerodrome from the air;

“aerodrome licence” means a licence to operate an aerodrome issued by the authority under Part III of these Regulations;

“aerodrome manual” means the manual that forms part of the application for an aerodrome certificate or an aerodrome licence under these Regulations, including any amendments to the aerodrome manual, approved by the authority;

“aerodrome mapping data” means data collected for the purpose of compiling aerodrome mapping information for aeronautical uses;

“aerodrome mapping database” means a collection of aerodrome mapping data organised and arranged as a structured data set;

“aerodrome operator” in relation to a certified or licensed aerodrome, means, the holder of an aerodrome certificate or licence;

“aerodrome reference code” means a code used for planning purposes, to classify an aerodrome with respect to the critical aircraft characteristics for which the aerodrome is intended;

“aerodrome reference point” means the designated geographical location of an aerodrome;

“aerodrome traffic density” means—

- (a) light—where the number of movements in the mean busy hour is not greater than 15 per runway or typically less than 20 total aerodrome movements;
- (b) medium—where the number of movements in the mean busy hour is of the order of 16 to 25 per runway or typically between 20 to 35 total aerodrome movements;



- (c) heavy—where the number of movements in the mean busy hour is of the order of 26 or more per runway or typically more than 35 total aerodrome movements;

“aeronautical beacon” means an aeronautical ground light visible at all azimuths, either continuously or intermittently, to designate a particular point on the surface of the earth;

“aeronautical ground light” means any light provided as an aid to air navigation, other than a light displayed on an aircraft;

“Aeronautical Information Circular” means a notice containing information that does not qualify for the origination of a NOTAM or for inclusion in the Aeronautical Information Publication, but which relates to flight safety, air navigation, technical, administrative or legislative matters;

“Aeronautical Information Publication” means a publication issued by the authority containing aeronautical information of a lasting character essential to air navigation;

“aeroplane” means a power driven heavier than an aircraft, deriving its lift in the flight chiefly from aerodynamic reactions on surfaces which remain fixed under a given conditions of flight;

“aeroplane reference field length” means the minimum field length required for take-off at maximum certificated take-off mass, sea-level, standard atmospheric conditions, still air and zero runway slope, as shown in the appropriate aeroplane flight manual prescribed by the certificating authority or equivalent data from the aeroplane manufacturer,

“AIRAC” means Aeronautical Information Regulation and Control;

“air traffic service” means a flight information service, alerting service, air traffic advisory service, or air traffic control service;

“air traffic service unit” means an air traffic control unit, flight information center or air traffic services reporting office;

“aircraft” means any machine that can derive support in the atmosphere from the reactions of the air other than the reactions of the air against the earth’s surface;

“Aircraft Classification Number (ACN)” means a number expressing the relative effect of an aircraft on a pavement for a specified standard subgrade category and shall remain in force up to 27 November 2024;

“Aircraft Classification Rating (ACR)” means a number expressing the relative effect of an aircraft on a pavement for a specified standard subgrade category and shall come into force on 28 November 2024;

“aircraft stand” means a designated area on an apron intended to be used for parking an aircraft;

“Appeals Tribunal” means the Appeals Tribunal established under section 43 of the Act.

“apron” means a defined area, on an aerodrome, intended to accommodate aircraft for purposes of loading or unloading of passengers, mail or cargo, fuelling, parking or maintenance;

“apron management service” means a service provided to regulate the activities and the movement of aircraft and vehicles on an apron;

“arresting system” means a system designed to decelerate an aeroplane overrunning the runway;

“authority” means the Uganda Civil Aviation Authority;

- “authorised person” means any person authorised by the authority either generally or in relation to a particular case or class of cases and reference to an authorised person includes references to the holder for the time being of an office designated by the authority;
- “Autonomous Runway Incursion Warning System” means a system which provides autonomous detection of a potential incursion or of the occupancy of an active runway and a direct warning to a flight crew or a vehicle operator;
- “azimuth” means the angle measurement in a spherical coordinate system;
- “balked landing” means a landing manoeuvre that is unexpectedly discontinued at any point below the obstacle clearance altitude or height (OCA/H);
- “barrette” means three or more aeronautical ground lights closely spaced in a transverse line so that from a distance they appear as a short bar of light;
- “calendar” means discrete temporal reference system that provides the basis for defining temporal position to a resolution of one day;
- “capacitor discharge lights” means a lamp in which high-intensity flashes of extremely short duration are produced by the discharge of electricity at high voltage through a gas enclosed in a tube;
- “certified aerodrome” means an aerodrome whose operator has been granted an aerodrome certificate;
- “clearway” means a defined rectangular area on the ground or water under the control of the aerodrome operator selected or prepared as a suitable area over which an aeroplane may make a portion of its initial climb to a specified height;

“contaminated runway” means a runway is contaminated when a significant portion of the runway surface area, whether in isolated areas or not, within the length and width being used is covered by one or more of the substances listed in the runway surface condition descriptors;

“controlled aerodrome” means an aerodrome where air traffic control services are provided;

“critical aircraft” means the most demanding aircraft with regard to the aircraft performance and dimensions for a range of aircraft and for which the aerodrome facilities is intended;

“critical area” means an area of defined dimensions extending about the ground antennae of a precision instrument approach equipment within which the presence of vehicles or aircraft will cause unacceptable disturbance of the guidance signals;

“cross wind component” means the surface wind component at right angles to the runway center line;

“dangerous good” means an article or substance which is capable of posing a risk to the health, safety, property or the environment;

“data accuracy” means a degree of conformance between the estimated or measured value and the true value;

“data integrity (assurance level)” means a degree of assurance that an aeronautical data and its value has not been lost or altered since the data origination or authorised amendment;

“data quality” means a degree or level of confidence that the data provided meet the requirements of the data user in terms of accuracy, resolution and integrity or equivalent assurance level, traceability, timeliness, completeness and format;

“datum” means any quantity or set of quantities that may serve as a reference or basis for the calculation of other quantities;

“declared distance” means —

“accelerate-stop distance available (ASDA)” which is the length of the take-off run available plus the length of the stop way, where provided;

“landing distance available (LDA)” which is the length of the runway which is declared available and suitable for the ground run of an aeroplane landing;

“take-off distance available (TODA)” which is the length of the take-off run available plus the length of the clearway, where provided;

“take-off run available (TORA)” which is the length of runway declared available and suitable for the ground run of an aeroplane taking off;

“dependent parallel approaches” means simultaneous approaches to parallel or near-parallel instrument runways where radar separation minima between aircraft on adjacent extended runway center lines are prescribed;

“director general” means the director general of the authority appointed under section 14 of the Act;

“displaced threshold” means a threshold not located at the extremity of a runway;

“DME” means Distance Measuring Equipment;

“dry runway” means a runway whose surface is free of visible moisture and not contaminated within the area intended to be used;

“effective intensity” means the effective intensity of a flashing light is equal to the intensity of a fixed light of the same colour which will produce the same visual range under identical conditions of observation;

“ellipsoid height or geodetic height” means the height related to the reference ellipsoid, measured along the ellipsoidal outer normal through the point in question;

“field length” means balanced field length for aeroplane, where applicable, or take-off distance in other cases;

“fixed light” means a light having constant luminous intensity when observed from a fixed point;

“Foreign Object Debris (FOD)” means an inanimate object within the movement area which has no operational or aeronautical function and which has the potential to be a hazard to aircraft operations;

“frangible object” means an object of low mass designed to break, distort or yield on impact so as to present the minimum hazard to aircraft;

“geodetic datum” means a minimum set of parameters required to define location and orientation of the local reference system with respect to the global reference system or frame;

“geoid” means the equipotential surface in the gravity field of the earth which coincides with the undisturbed Mean Sea Level (MSL) extended continuously through the continents;

- “geoid undulation” means the distance of the geoid above, or below, the mathematical reference ellipsoid;
- “GNSS” means the Global Navigation Satellite System;
- “Gregorian calendar” means the calendar in use first introduced in 1582 to define a year that more closely approximates the tropical year than the Julian calendar year;
- “hazard beacon” means an aeronautical beacon used to designate a danger to air navigation;
- “heliport” means an aerodrome or a defined area on a structure intended to be used wholly or in part for the arrival, departure and surface movement of helicopters;
- “holding bay” means a defined area where aircraft can be held, or bypassed, to facilitate efficient surface movement of aircraft;
- “hot spot” means a location on an aerodrome movement area with a history or potential risk of collision or runway incursion, and where heightened attention by pilots or drivers is necessary;
- “human factors principles” means principles which apply to aeronautical design, certification, training, operations and maintenance and which seek safe interface between the human and other system components by proper consideration to human performance;
- “human performance” means human capabilities and limitations which have impact on the safety and efficiency of aeronautical operations;
- “identification beacon” means an aeronautical beacon emitting a coded signal by means of which a particular point of reference can be identified;
- “ILS” means Instrument Landing System;

“incident” means an occurrence other than an accident associated with the operation of an aircraft, which affect or may affect the safety of operation of aircraft;

“independent parallel approaches” means simultaneous approaches to parallel or near-parallel instrument runways where radar separation minima between aircraft on adjacent extended runway center lines are not prescribed;

“independent parallel departures” means simultaneous departures from parallel or near-parallel instrument runways;

“instrument runway” means one of the following types of runways intended for the operation of aircraft using instrument approach procedures—

(a) “non-precision approach runway” means a runway served by visual aids and non-visual aids intended for landing operations following an instrument approach operation type A and a visibility of not less than 1000m;

(b) “precision approach runway, category I” means a runway served by visual aids and non-visual aids intended for landing operations following an instrument approach operation type B with a decision height (DH) not lower than 200ft and either a visibility of not less than 800m or a runway visual range of not less than 550m;

(c) “precision approach runway, category II” means a runway served by visual aids and non-visual aids intended for landing operations following an instrument approach operation type B with a decision height (DH) lower than 200ft but not lower than 100ft and a runway visual range of not less than 300m;



- (d) “precision approach runway category III” means a runway served by visual aids and non-visual aids intended for landing operations following an instrument approach operation type B with a decision height (DH) lower than 100ft, or no decision height and a runway visual range of less than 300m, or no runway visual range limitations;

**Note:** visual aids need not necessarily be matched to the scale of non-visual aids provided. The criterion for the selection of visual aids is the conditions in which operations are intended to be conducted;

“integrity classification” means a classification based upon the potential risk resulting from the use of corrupted data, and aeronautical data is classified as—

- (a) routine data: where there is a very low probability when using the corrupted routine data that the continued safe flight and landing of an aircraft would be severely at risk with the potential for catastrophe;
- (b) essential data: where there is a low probability when using the corrupted essential data that the continued safe flight and landing of an aircraft would be severely at risk with the potential for catastrophe; and
- (c) critical data: where there is a high probability when using the corrupted critical data that the continued safe flight and landing of an aircraft would be severely at risk with the potential for catastrophe;

“intermediate holding position” means a designated position intended for traffic control at which taxiing aircraft and vehicles shall stop and hold until they are cleared to proceed, when so instructed by the aerodrome control tower;

- “landing area” means that part of a movement area intended for the landing or take-off of aircraft;
- “landing direction indicator” means a device to indicate visually the direction currently designated for landing and take-off;
- “laser-beam critical flight zone (LCFZ)” means airspace in the proximity of an aerodrome but beyond the LFFZ where the irradiance is restricted to a level unlikely to cause glare effects;
- “laser-beam free flight zone (LFFZ)” means airspace in the immediate proximity of the aerodrome where the irradiance is restricted to a level unlikely to cause any visual disruption;
- “laser-beam sensitive flight zone (LSFZ)” means airspace outside, and not necessarily contiguous with, the LFFZ and LCFZ where the irradiance is restricted to a level unlikely to cause flash-blindness or after-image effects;
- “lighting system reliability” means the probability that the complete installation operates within the specified tolerances and that the system is operationally usable;
- “manoeuvring area” means that part of an aerodrome to be used for the take-off, landing and taxiing of aircraft, excluding aprons;
- “marker” means an object displayed above ground level in order to indicate an obstacle or delineate a boundary;
- “marking” means a symbol or group of symbols displayed on the surface of the movement area in order to convey aeronautical information;

“movement area” means that part of an aerodrome to be used for take-off, landing and taxiing of aircraft, consisting of the manoeuvring area and the apron;

“NDB” means non-directional radio beacon;

“near-parallel runways” means non-intersecting runways whose extended center lines have an angle of convergence or divergence of 15 degrees or less;

“non-instrument runway” means a runway intended for the operation of aircraft using visual approach procedures or an instrument approach procedure to a point beyond which the approach may continue in visual meteorological conditions;

“normal flight zone (NFZ)” means airspace not defined as LFFZ, LCFZ or LSFZ but which must be protected from laser radiation capable of causing biological damage to the eye;

“NOTAM” means a notice distributed by means of telecommunication containing information concerning the establishment, condition or change in any aeronautical facility, service, procedure or hazard, the timely knowledge of which is essential to personnel concerned with flight operations;

“obstacle” means all fixed, whether temporary or permanent, and mobile object, or part of that object, that—

- (a) is located on an area intended for the surface movement of aircraft;
- (b) extends above a defined surface intended to protect aircraft in flight; or
- (c) stands outside those defined surfaces and has been assessed as being a hazard to air navigation;

“obstacle free zone (OFZ)” means the airspace above the inner approach surface, inner transitional surfaces, the balked landing surface and that portion of the strip bounded by these surfaces, which is not penetrated by any fixed obstacle other than a low-mass and frangibly mounted one required for air navigation purposes;

“obstacle limitation surfaces” means a series of surfaces that define the volume of airspace at and around an aerodrome to be kept free of obstacles in order to permit the intended aircraft operations to be conducted safely and to prevent the aerodrome from becoming unusable by the growth of obstacles around the aerodrome;

“orthometric height” means height of a point related to the geoid, generally presented as an MSL elevation;

“OPS” means Obstacle Protection Surface;

“Outer Main Gear Wheel Span (OMGWS) means the distance between the outside edges of the main gear wheels;

“Pavement Classification Number (PCN)” means a number expressing the bearing strength of a pavement for unrestricted operations and shall remain in force until 27 November 2024;

“Pavement Classification Rating (PCR)” means a number expressing the bearing strength of a pavement and shall come into force on the 28 November 2024;

“precision approach runway” means one of the following types of runways—

- (a) “precision approach runway, category I” which is a runway served by visual aids and non-visual aids, intended for landing operations following an instrument approach operation type B with a decision height (DH) not lower than 200ft and either

a visibility of not less than 800m or a runway visual range of not less than 550m;

- (b) “precision approach runway, category II” which is a runway served by visual aids and non-visual aids intended for landing operations following an instrument approach operation type B with a decision height (DH) lower than 200ft but not lower than 100ft and a runway visual range not less than 300m;
- (c) “precision approach runway category III” which is a runway served by visual aids and non-visual aids intended for landing operations following an instrument approach operation type B with a decision height (DH) lower than 100ft, or no decision height and a runway visual range less than 300m, or no runway visual range limitations;

“prescribed” means prescribed by the authority in circulars, orders, notices, aeronautical publications and any other related technical guidance material;

“primary runway” means a runway used in preference to others whenever conditions permit;

“protected flight zones” means an airspace specifically designated to mitigate the hazardous effects of laser radiation;

“relevant authority” means any authority other than the Uganda Civil Aviation Authority whose action may be necessary or complimentary for the implementation of these Regulations;

“RFF” means rescue and fire-fighting;

“road” means an established surface route on the movement area meant for the exclusive use of vehicles;

“road-holding position” means a designated position at which vehicles may be required to hold;

“runway” means a defined rectangular area on a land aerodrome prepared for the landing and take-off of aircraft;

“runway condition assessment matrix (RCAM)” means a matrix allowing the assessment of the runway condition code, using associated procedures, from a set of observed runway surface conditions and pilot report of braking action;

“runway condition code (RWYCC)” means a number describing the runway surface condition to be used in the runway condition report;

“runway condition report (RCR)” means a comprehensive standardised report relating to the runway surface condition and its effect on the aeroplane landing and take-off performance;

“runway end safety area (RESA)” means an area symmetrical about the extended runway center line and adjacent to the end of the strip primarily intended to reduce the risk of damage to an aeroplane undershooting or overrunning the runway;

“runway guard lights” means a light system intended to caution pilots or vehicle drivers that they are about to enter an active runway;

“runway-holding position” means a designated position intended to protect a runway, an obstacle limitation

surface, or an ILS or Microwave Landing System critical or sensitive area at which taxiing aircraft and vehicles shall stop and hold, unless otherwise authorised by the aerodrome control tower;

“runway strip” means a defined area including the runway and stopway, where provided, intended—

- (a) to reduce the risk of damage to aircraft running off a runway; and
- (b) to protect aircraft flying over it during take-off or landing operations;

“runway surface condition” means a description of the condition of the runway surface used in the runway condition report which establishes the basis for the determination of the runway condition code for aeroplane performance purposes;

“runway turn pad” means a defined area on a land aerodrome adjacent to a runway for the purpose of completing a 180-degree turn on a runway;

“Runway Visual Range (RVR)” means the range over which a pilot of an aircraft on the center line of a runway can see the runway surface markings or the lights delineating the runway or identifying its center line;

“safety” means a state in which the risks associated with aviation activities, related to, or indirect support of the aircraft, are reduced and controlled to an acceptable level;

“safety management system” means a systematic approach to managing safety including the necessary organisational structure, accountabilities, policies and procedures;

“segregated parallel operations” means simultaneous operations on parallel or near-parallel instrument runways in which one runway is used exclusively for approaches and the other runway is used exclusively for departures;

“short take-off and landing airport (STOLPORT)” means an airport designed for aircraft that can do short take-offs and landings and only require a short runway;

“shoulder” means an area adjacent to the edge of a pavement, prepared to provide a transition between the pavement and the adjacent surface;

“sign” means —

- (a) a fixed message sign that is a sign presenting only one message; or
- (b) a variable message sign, that is, a sign capable of presenting several predetermined messages or no message, as applicable;

“signal area” means an area on an aerodrome used for the display of ground signals;

“slippery wet runway” means a wet runway where the surface friction characteristics of a significant portion of the runway have been determined to be degraded;

“SMGCS” means surface movement guidance and control systems;

“standing water” means water of depth greater than 3 mm;

“station declination” means an alignment variation between the zero degree radial of a VOR and true north, determined at the time the VOR station is calibrated;

“stopway” means a defined rectangular area on the ground at the end of the take-off run available, prepared as a



suitable area in which an aircraft can be stopped in the case of an abandoned take-off;

“switch-over time” means the time required for the actual intensity of a light measured in a given direction to fall from 50 percent and recover to 50 percent during a power supply change-over, when the light is being operated at intensities of 25 percent or above;

“take-off runway” means a runway intended for take-off only;

“taxiway” means a defined path on a land aerodrome established for the taxiing of aircraft and intended to provide a link between one part of the aerodrome and another, and includes—

- (a) aircraft stand taxilane which is a portion of an apron designated as a taxiway and intended to provide access to aircraft stands only;
- (b) an apron taxiway which is a portion of a taxiway system located on an apron and intended to provide a through taxi route across the apron; and
- (c) a rapid exit taxiway which is a taxiway connected to a runway at an acute angle and designed to allow landing aircrafts to turn off at higher speeds than are achieved on other exit taxiways thereby minimising runway occupancy times;

“taxiway intersection” means a junction of two or more taxiways;

“taxiway strip” means an area including a taxiway intended to protect aircraft operating on a taxiway and to reduce the risk of damage to an aircraft accidentally running off the taxiway;

“threshold” means the beginning of that portion of the runway usable for landing;

“touchdown zone” means the portion of a runway beyond the threshold, where it is intended landing aeroplanes first contact the runway;

“unserviceable area” means a part of the movement area that is unfit and unavailable for use by aircraft;

“usability factor” means the percentage of time during which the use of a runway or system of runways is not restricted because of the crosswind component;

“vicinity” means a defined airspace around an aerodrome for control of obstacles and comprises obstacle limitation surfaces around the aerodrome and may extend to a radius of fifteen kilometers from the aerodrome reference point, to a height of five hundred feet above ground level;

“VOR” means Very High Frequency (VHF) Omnidirectional Radio Range;

“wet runway” means the runway surface is covered by visible dampness or water up to and including 3 mm deep within the intended area of use;

“wildlife” means feral birds and animals, including domestic animals out of the control of their owners;

“wildlife hazard” means the presence of wildlife that could result in damage to an aircraft;

#### **4. Certification of aerodromes**

A person shall not operate an aerodrome used for international operations unless that person holds a certificate issued by the authority in accordance with these Regulations.

#### **5. Use of common reference systems**

(1) The World Geodetic System–1984 (WGS-84) shall be used as the horizontal or Geodetic reference system.

(2) The reported aeronautical geographical coordinates indicating latitude and longitude shall be expressed in terms of the WGS-84 geodetic reference datum.

(3) The Mean Sea Level (MSL) datum which gives the relationship of gravity-related height (elevation) to a surface known as the geoid, shall be used as the vertical reference system at all aerodromes.

(4) The Earth Gravitational Model–1996 (EGM-96), containing long wave length gravity field data to degree and order 360, shall be used by aerodrome operators as the gravity model.

(5) The Gregorian calendar and Coordinated Universal Time (UTC) shall be used as the temporal reference systems except where notified in GEN 2.1.2 of the Uganda Aeronautical Information Publication.

(6) The International System of Units developed and maintained by the General Conference on Weights and Measures (CGPM) shall be used as the standard system of units of measurement unless otherwise prescribed by the authority.

## **6. Categories of aerodromes**

Aerodromes shall be categorised as follows —

- (a) category A comprising aerodromes available for use by both international and domestic air traffic;
- (b) category B available for use by domestic air traffic including aircraft of maximum certificated take-off mass above five thousand seven hundred kilogrammes;
- (c) category C comprising aerodromes available for use only by domestic air traffic of maximum certificated take-off mass not exceeding five thousand seven hundred kilogrammes; and
- (d) category D – Heliports comprising aerodromes available for use only by domestic helicopters operations.

## PART II—CONSTRUCTION OF AERODROMES

### 7. **Requirements for application for aerodrome construction permit**

(1) A person shall not construct an aerodrome unless that person has a valid aerodrome construction permit issued under regulation 8.

(2) A person shall submit an application for an aerodrome construction permit to the authority in the prescribed form and the application shall be accompanied by—

- (a) a proof of ownership of the proposed aerodrome site master plan as specified in regulation 10;
- (b) a detailed design of the proposed construction including related architectural requirements for approval by the relevant authority;
- (c) aerodrome data in accordance with the characteristics of the aircraft for which the aerodrome is intended;
- (d) a topographical map of the proposed aerodrome site as specified by the authority; and
- (e) an environmental impact assessment report approved by the National Environment Management Authority.

(3) An application for an aerodrome construction permit shall be considered for approval by the authority, where the application is accompanied by an environmental impact assessment report approved by the National Environment Management Authority.

(4) The authority shall prior to issuance of a construction permit, assess the suitability of the place proposed for construction taking into consideration—

- (a) the proximity of the place to other aerodromes and landing areas including military aerodromes;
- (b) obstacles, terrain and existing airspace restrictions; and

- (c) that it is not against public interest that the place where the aerodrome is to be constructed shall be used as such.

## **8. Issuance of aerodrome construction permit**

The authority shall issue an aerodrome construction permit to an applicant whose application meets the requirements in regulation 7 and any other requirements specified by a relevant authority.

## **9. Design and construction of aerodrome**

(1) An applicant for a construction permit shall ensure that the design and construction of the aerodrome is undertaken by a person registered by the relevant professional body.

(2) The authority shall inspect the site of an aerodrome during construction to ascertain compliance with these Regulations, the Civil Aviation (Security) Regulations, 2022, other applicable national laws and the terms of the aerodrome construction permit.

## **10. Aerodrome master plan**

(1) An aerodrome master plan containing detailed plans for the development of aerodrome infrastructure shall be established for Category A aerodromes, and other aerodromes as determined by the authority from time to time.

(2) Notwithstanding subregulation (1) the authority may require an aerodrome operator to establish a master plan for a Category B or C aerodrome.

(3) A master plan shall represent the development plan of a specific aerodrome and shall be developed by the aerodrome operator based on economic feasibility, traffic forecasts, and current and future requirements provided by aircraft operators among others.

(4) A master plan may be required where the lack of capacity at an airport, due to conditions such as, but not limited to expected traffic growth, changing weather and climatic conditions or major works to address safety or environmental concerns, would put the connectivity of a geographical area at risk or cause severe disruption to the air transport network.

- (5) The master plan shall—
  - (a) contain a schedule of priorities including a phased implementation plan; and
  - (b) be reviewed periodically to take into account current and future aerodrome traffic.

(6) Aerodrome stakeholders, particularly aircraft operators, may be consulted in order to facilitate the master planning process using a consultative and collaborative approach.

(7) An aerodrome operator shall when applying for a Category A aerodrome certificate, submit to the authority a master plan for the aerodrome.

## **11. Requirements for aerodrome design**

- (1) An aerodrome design shall indicate —
  - (a) the physical characteristics in accordance with these Regulations;
  - (b) the obstacle limitation surfaces;
  - (c) visual aids for navigation; and
  - (d) the appropriate equipment and installations.

(2) The physical characteristics, obstacle limitation surfaces, visual aids and equipment and installations, required under subregulation(1) shall—

- (a) be appropriate to the critical aircraft characteristics for which the aerodrome intends to serve;
- (b) be at the lowest meteorological minima for each runway;
- (c) provide ambient light conditions during the operations of aircraft; and

(d) comply with the appropriate aerodrome design requirements as prescribed by the authority.

(3) Architectural and infrastructure-related requirements for the optimum implementation of the Civil Aviation (Security) Regulations, 2022 shall be integrated into the design and construction of new facilities and alterations to existing facilities at an aerodrome.

(4) The design of an aerodrome shall take into account existing land use and environmental control measures.

## 12. Aerodrome reference code

(1) An aerodrome reference code comprising a code number and a code letter shall be used for aerodrome planning purposes.

(2) The authority in consultation with the aerodrome operator shall determine the aerodrome reference code in accordance with the characteristics of the aeroplane for which the aerodrome facility is intended.

(3) The aerodrome reference code numbers and letters required under subregulation(1) shall have the meanings assigned to them in Table 1.

**Table 1: Aerodrome reference code**

**Table 1 A: Code element 1**

<i>Code number</i>	<i>Aeroplane reference field length</i>
1	Less than 800m
2	800m up to but not including 1200m
3	1200m up to but not including 1800m
4	1800m and over

**Table 1 B: Code element 2**

Code Letter	Wingspan
A	Up to but not including 15m
B	15m up to but not including 24m
C	24m up to but not including 36m
D	36m up to but not including 52m
E	52m up to but not including 65m
F	65m up to but not including 80m

(4) The code number for element 1 shall be determined from Table 1A, column 1 by selecting the code number corresponding to the highest value of the aeroplane reference field lengths of the aeroplane for which the runway is intended.

(5) The code letter for element 2 shall be determined from Table 1B, by selecting the code letter which corresponds to the greatest wingspan of the aeroplanes for which the facility is intended.

PART III—LICENSING OF AERODROMES

**13. Application of this Part**

(1) This part of the regulations shall apply to aerodromes in Categories B and C except where otherwise specified by the authority.

(2) A person shall not operate an aerodrome in Categories B and C without a licence issued by the authority.

**14. Application for licence**

(1) An application for an aerodrome licence under this part shall be made to the authority using an aerodrome licence application form and the application shall be accompanied by—



- (a) an aerodrome manual;
- (b) a site plan for the aerodrome;
- (c) evidence of financial capability in the case of aerodromes in Category B;
- (d) particulars of any non-compliance or deviations from the appropriate aerodrome design, operation or equipment standards;
- (e) evidence of payment of charges prescribed by the authority in the Aeronautical Information Circular; and
- (f) approval from any relevant authority.

(2) An application for an aerodrome licence shall be made using the form obtained from the authority or from the website of the authority, [www.caa.go.ug](http://www.caa.go.ug).

## **15. Conditions for issuance of licence**

(1) A licence may be issued subject to the conditions prescribed by the authority.

(2) The authority shall endorse on a licence the conditions for use of an aerodrome and any other details as may be considered necessary by the authority.

(3) Subject to subregulation (4), where an applicant requests or the authority considers, that an aerodrome shall be available for public use, an aerodrome licence may be granted subject to a condition that the aerodrome shall at all times be available to all persons on equal terms and conditions.

(4) An aerodrome operator shall not refuse an aircraft in an emergency situation from using the aerodrome.

## **16. Issuance of licence**

(1) The authority may issue an aerodrome licence in the prescribed form and manner where—

- (a) the aerodrome is properly and adequately equipped and the applicant can demonstrate organisational competence in providing a safe aerodrome operating environment for aircraft and relevant activities using the aerodrome in accordance with these Regulations;
- (b) the physical characteristics, equipment and installations of the aerodrome and its surroundings are safe for use by aircraft;
- (c) the applicant has appropriate organisation, staffing, maintenance and other arrangements; and
- (d) the applicant for a licence complies with the requirements in the National Security Programme.

(2) The issuance of an aerodrome licence shall be subject to compliance with these Regulations and standards prescribed by the authority and any other condition as may be specified or notified by the authority in accordance with the safety audit and inspection.

(3) The authority may refuse to grant a licence to an applicant, and where the authority does not grant the licence, the authority shall notify the applicant in writing, of the reasons for the refusal, not later than fourteen days after making that decision.

(4) The authority shall, following the issuance of an aerodrome licence, carry out surveillance inspections for purposes of assessing the capacity of the aerodrome operator to maintain safe and regular operation of the aerodrome and its associated facilities and services.

## **17. Breach of conditions of licence and non-conformity with licensing requirements**

(1) The breach of any condition subject to which a licence is issued in respect of its approval, permission or exemption shall render the licence invalid.

(2) The authority shall impose operating restrictions or sanctions at a licensed aerodrome in the event of non-conformity with the licensing requirements or any unresolved safety concerns.

## **18. Specifications of aerodrome licence**

- (1) An aerodrome licence shall specify—
  - (a) the category of the aerodrome and the aerodrome reference code;
  - (b) the restrictions, if any relating to non-compliance with or deviations from the appropriate aerodrome design, operations or equipment standards;
  - (c) any conditions for use of the aerodrome; and
  - (d) the period of validity of the licence.

(2) A licence issued under these Regulations shall not be transferable.

## **19. Validity of licence**

A holder of an aerodrome licence which is suspended or cancelled shall within thirty days of the suspension or cancellation, surrender the licence to the authority.

## **20. Renewal of licence**

(1) An application for the renewal of an aerodrome licence shall be made to the authority using the aerodrome licence application form issued by the authority, and shall be accompanied by—

- (a) the aerodrome manual where significant changes have been made following the initial licensing;
- (b) particulars of deviations, if any, from the appropriate design, operation or equipment standards; and
- (c) evidence of payment of the appropriate charges prescribed by the authority in the Aeronautical Information Publication or Aeronautical Information Circular.

(2) The authority shall inspect the aerodrome and associated facilities for the purpose of ensuring compliance with applicable requirements before a licence is renewed.

(3) The renewal of an aerodrome licence shall be subject to compliance with these Regulations, the standards prescribed by the authority and any other conditions specified or notified by the authority and determined by safety inspections or audits by the authority.

(4) An application for renewal of an aerodrome licence shall be submitted sixty days before the expiry of the licence.

## **21. Amendment of licence**

(1) The authority may, amend a licence provided the conditions in regulation 16 are complied with—

- (a) for a change in the use or operation of the aerodrome;
- (b) for a change in the boundaries of the aerodrome; or
- (c) where the amendment is requested for by the holder of the licence.

(2) An application for amendment of an aerodrome licence shall be submitted in the form prescribed by the authority.

(3) The authority may prescribe that the application referred to in subregulation (2) should be accompanied by any of the following—

- (a) an aerodrome manual;
- (b) a site plan for the aerodrome;
- (c) approval from any relevant authority ;
- (d) a report of the safety assessment and change management process; and
- (e) evidence of payment of the prescribed charges under the Aeronautical Information Publication or Aeronautical Information Circular issued by the authority.

## **22. Interim aerodrome licence**

(1) The authority may issue an interim aerodrome licence to an applicant, authorising the applicant to operate an aerodrome where the authority is satisfied that—

- (a) an aerodrome licence in respect of the aerodrome will be issued to the applicant, as soon as the application procedure for the grant of an aerodrome licence has been completed; and
- (b) the grant of the interim licence is in public interest and is not detrimental to aviation safety.

(2) An interim aerodrome licence referred to in subregulation (1) shall be valid for a maximum period of six months.

(3) An interim aerodrome licence referred to in subregulation (1) shall expire on—

- (a) the date on which the aerodrome licence is issued; or
- (b) the date of expiry of the licence specified in the interim aerodrome licence;

whichever is earlier.

(4) All the conditions that apply to an aerodrome licence shall, in the same manner apply to the interim aerodrome licence.

## **23. Suspension of licence**

(1) The authority may suspend an aerodrome licence where—

- (a) following conduct of a safety inspection or audit, it is evident that the holder of the licence has not complied with the requirements prescribed in these Regulations and has failed to remedy the non-compliance within a period of thirty days after the inspection;
- (b) the holder of the licence prevents the authority from carrying out a safety inspection or audit in accordance with these Regulations;

- (c) the holder of the licence is under receivership, liquidation or bankruptcy proceedings;
- (d) the holder of the licence resists or is unwilling to take action to correct or mitigate a condition identified by the authority affecting aviation safety;
- (e) the holder of the licence fails to perform an already agreed upon corrective action and suspension of the licence is the last resort to avoid unsafe operations in the aerodrome movement area;
- (f) the authority considers it necessary in the interest of aviation safety; and
- (g) the holder of the licence voluntarily gives notice in writing to the authority;

(2) The authority may suspend the licence for a period of not more than sixty days and inform the holder of the licence, in writing of the reasons for suspension of the licence.

(3) A holder of an aerodrome licence who is notified of a suspension under subregulation (2) may submit a response in writing within a period of fourteen days from the date of notification.

(4) Notwithstanding subregulation(3), the authority may suspend any or all of the operations at an aerodrome pending receipt of a response from the holder.

(5) A holder of an aerodrome licence aggrieved with the suspension of his or her aerodrome licence may appeal against the suspension to the director general of the authority, within forty eight hours from the date of the suspension.

(6) A holder of an aerodrome licence who is aggrieved with the suspension of a licence may appeal against the suspension to the Appeals Tribunal, within fourteen days from the date of the suspension.

(7) Where an appeal is made under subregulation(5), the holder of a licence shall state in writing the reasons why in his or her opinion, the suspension should be varied or set aside.

(8) Where a holder of an aerodrome licence does not appeal against the suspension in accordance with subregulation (6), a holder of the licence shall surrender the licence to the authority within thirty days.

(9) Notwithstanding subregulation (2), where an aerodrome licence is suspended for a period of less than thirty days, the holder of the licence shall immediately surrender the licence.

## **24. Cancellation of licence**

(1) The authority may cancel an aerodrome licence where—

- (a) the licence holder is incapable or unwilling to carry out corrective action or has repeatedly committed serious violations;
- (b) the licence holder has demonstrated a lack of responsibility, such as deliberate and flagrant acts of non-compliance or falsification of records jeopardising aviation safety;
- (c) the licence holder has made it convincingly clear that the continued operation of the aerodrome will be detrimental to the public interest; or
- (d) the aerodrome operator surrenders the licence to the authority.

(2) A holder of an aerodrome licence who is aggrieved by the cancellation of a licence may appeal against the cancellation to the director general of the authority within forty eight hours from the date of cancellation.

(3) A holder of a licence who is aggrieved by the cancellation of a licence may appeal against the cancellation to the Appeals Tribunal, within fourteen days from the date of the cancellation.

## **25. Surrender of licence**

(1) Subject to subregulation (2), a holder of a licence may at any time surrender the licence to the authority.

(2) A holder of a licence who wishes to surrender the licence shall give the authority not less than sixty days' notice in writing of his or her intention to surrender the licence, before surrendering the licence.

(3) The authority shall cancel the licence upon the expiry of the period of notice stated in subregulation (2).

(4) Where, after the expiry of the period stated in subregulation (2), an aerodrome is abandoned or is not maintained in accordance with the conditions of the licence, the holder of the licence shall remove, obliterate or modify the prescribed markings referred to in regulation 231(6).

## **26. Charges and fines at licensed aerodromes**

(1) A holder of an aerodrome licence shall prescribe charges for the use of the aerodrome or of any facilities provided at the aerodrome for the safety, security, efficiency and regulation of air navigation.

(2) A holder of an aerodrome licence shall, where the authority requires, furnish the authority with the particulars of the charges levied for the use of the aerodrome or the performance of services at the aerodrome.

(3) Notwithstanding subregulation (1), the authority may where necessary, prescribe the maximum charges that may be levied for the use of an aerodrome or for the performance of services at the aerodrome, for a specific period.

(4) A holder of a licence of an aerodrome for which the authority prescribes maximum charges under subregulation (3) shall not cause or permit any charges to be made in contravention of the subregulation.



(5) A holder of a licence of an aerodrome for which the authority prescribes charges shall post the prescribed charges in a conspicuous place at the aerodrome.

## **27. Licence register**

(1) The authority shall maintain a register of all the licences issued for aerodromes in accordance with these Regulations.

(2) The register shall contain the —

- (a) full name of the holder of a licence;
- (b) nationality of the holder of a licence;
- (c) postal, telephone, facsimile and e-mail addresses of a holder of a licence;
- (d) name and location of the aerodrome for which a licence is issued;
- (e) number of the licence;
- (f) the date of issue and date of expiry of the licence; and
- (g) any other relevant information.

## **28. Notification and furnishing of information**

An aerodrome operator shall —

- (a) in the case of a licence to operate an aerodrome for public use, issue notice of the times during which the aerodrome is available for take-off and landing of aircraft for public transport or instruction in flying; and
- (b) upon request, furnish information concerning the terms of the licence to an authorised person.

### **PART IV— CERTIFICATION OF AERODROMES**

## **29. Application of this Part**

- (1) This Part applies to aerodromes in Category A.

(2) This Part may apply to aerodromes in Category B where the authority considers it necessary or where requested by an aerodrome operator.

### **30. Application for certificate**

(1) An application for an aerodrome certificate shall be made to the authority on the aerodrome certificate application form and shall be accompanied by —

- (a) two copies of the aerodrome manual;
- (b) a site plan for the aerodrome;
- (c) an environmental impact assessment report approved by the National Environment Management Authority;
- (d) approval from any other relevant authority;
- (e) proof of financial capability;
- (f) particulars of any non-compliance or deviations from the appropriate aerodrome design, operation or equipment standards;
- (g) evidence of payment of the charges prescribed by the authority in the Aeronautical Information Publication or Aeronautical Information Circular;
- (h) details of competences of key aerodrome personnel including resume, history of training records and any other information that may be sought by the authority to ascertain the competency of the person as prescribed by the authority; and
- (i) an aerodrome survey report and drawings.

(2) The aerodrome certificate application forms may be obtained from the authority or in electronic format from the website of the authority, [www.caa.go.ug](http://www.caa.go.ug).

### **31. Conditions for issuance of certificate**

(1) A certificate may be issued subject to any conditions prescribed by the authority.

(2) The authority shall endorse on a certificate the conditions for use of an aerodrome and any other details as the authority may consider necessary.

### **32. Breach of conditions of certificate and non-conformance with the certification requirements**

(1) The breach of any condition subject to which a certificate is issued in respect of its approval, permission or exemption shall render the certificate invalid.

(2) The authority may impose operating restrictions or sanctions at a certified aerodrome in the event of non-conformance with the certification requirements or any unresolved safety concerns.

### **33. Aerodrome certificate**

(1) An aerodrome certificate shall specify —

- (a) the category of the aerodrome and the aerodrome reference code;
- (b) the operational restrictions at the aerodrome, if any;
- (c) the period of validity of the certificate;
- (d) absolute aerodrome minima (RVR);
- (e) critical aeroplane type;
- (f) the operational conditions for the accommodation of critical aeroplanes for which the facility is provided;
- (g) RFF category; and
- (h) the authorised deviations related to aerodrome compatibility, their inherent operational conditions and validity.

(2) An aerodrome certificate issued under these Regulations is not transferable.

### **34. Issuance of aerodrome certificate**

(1) The authority may issue an aerodrome certificate where the authority is satisfied that—

- (a) the applicant has an adequate number of personnel with the necessary competency and experience to operate and maintain an aerodrome;
- (b) the aerodrome manual prepared and submitted with the application contains all the relevant information;
- (c) the aerodrome facilities, services and equipment are established in accordance with the approved standards;
- (d) the aerodrome operating procedures make satisfactory provision for the safety of aircraft;
- (e) the applicant has an acceptable safety management system in place at the aerodrome; and

(f) the applicant has an approved aviation security programme in accordance with the Civil Aviation (Security) Regulations, 2022.

(2) The issuance of an aerodrome certificate shall be subject to compliance with these Regulations and standards prescribed by the authority and any other condition as may be specified or notified by the authority in accordance with the safety audit and inspection.

(3) The authority may refuse to grant an aerodrome certificate to an applicant and where the authority refuses, it shall notify the applicant in writing, of the reasons for the refusal, not later than fourteen days after making that decision.

(4) The authority shall following the issuance of the aerodrome certificate, carry out surveillance and inspections to ensure continuing validity of the aerodrome certificate and continuing capacity of the aerodrome operator to maintain safe and regular operation of the aerodrome and associated facilities and services.

(5) An aerodrome certificate issued under these Regulations is not transferable.

### **35. Validity of aerodrome certificate**

A certificate issued under these Regulations shall be valid for a period of three years, unless the certificate is surrendered, suspended or cancelled in accordance with these Regulations.

### **36. Renewal of aerodrome certificate**

(1) An application for renewal of an aerodrome certificate shall be submitted by the aerodrome certificate holder at least six months before the expiry of the certificate.

(2) An application for renewal of the certificate shall be made to the authority in the prescribed form and shall be accompanied by—

- (a) the aerodrome manual if significant changes have been made following the initial certification;
- (b) particulars of deviations, if any, from the appropriate design, operation or equipment standards; and
- (c) evidence of payment of the appropriate charges prescribed by the authority in the Aeronautical Information Circular.

(3) The renewal of an aerodrome certificate shall be subject to compliance with these Regulations, the standards prescribed by the authority and any other conditions specified or notified and determined under safety audit by the authority.

### **37. Amendment of aerodrome certificate**

(1) An application for amendment of an aerodrome certificate shall be submitted in a form prescribed by the authority in the Aeronautical Information Circular.

(2) The authority may request that the application be accompanied by any or all of the following—

- (a) two copies of the aerodrome manual;
- (b) a site plan for the aerodrome;
- (c) an environmental impact assessment report;

- (d) approval from any other relevant authority;
- (e) proof of financial capability;
- (f) particulars of any non-compliance or deviations from the appropriate aerodrome design, operation or equipment standards; and
- (g) evidence of payment of charges prescribed in the Aeronautical Information Publication or the Aeronautical Information Circular.

(3) The authority may, where the requirements set out in regulation 34 are met, amend an aerodrome certificate—

- (a) for a change in the use or operation of the aerodrome;
- (b) for a change in the boundaries of the aerodrome; or
- (c) where the holder of the aerodrome certificate requests an amendment.

### **38. Interim aerodrome certificate**

(1) The authority may issue an interim aerodrome certificate to the applicant, authorising the applicant to operate an aerodrome, if the authority is satisfied that—

- (a) an aerodrome certificate in respect of the aerodrome will be issued to the applicant, as soon as the application procedure for the grant of an aerodrome certificate has been completed; and
- (b) the grant of the interim certificate is in the public interest and is not detrimental to aviation safety.

(2) An interim aerodrome certificate referred to in subregulation (1) shall be valid for a maximum period of one year.

(3) An interim aerodrome certificate referred to in sub-regulation (1) shall expire on—

- (a) the date on which the aerodrome certificate is issued; or
- (b) the expiry date specified in the interim aerodrome certificate;

whichever is earlier.

### **39. Suspension of aerodrome certificate**

(1) The authority may suspend an aerodrome certificate where—

- (a) following a safety inspection or audit, it is evident that the holder of the aerodrome certificate has not complied with the requirements prescribed in these Regulations and has failed to remedy the non-compliance within a period of thirty days after the inspection;
- (b) the holder of the aerodrome certificate prevents the authority from carrying out a safety inspection or audit in accordance with these Regulations;
- (c) the holder of the aerodrome certificate is under receivership, liquidation or bankruptcy proceedings;
- (d) the holder of the aerodrome certificate voluntarily gives notice in writing to the authority;
- (e) the holder of the aerodrome certificate resists or is unwilling to take action to correct or mitigate a condition affecting aviation safety;
- (f) the holder of the aerodrome certificate fails to perform an already agreed upon corrective action and suspension of the certificate is the last resort to avoid unsafe operations in the aerodrome; and
- (g) the authority considers it necessary in the interest of aviation safety.

(2) The authority may, on giving reasons to the holder of an aerodrome certificate, suspend the certificate for a period not exceeding sixty days.

(3) A holder of an aerodrome certificate who is notified of a suspension under subregulation (2) may submit a response in writing within fourteen days from the date of notification.

(4) Notwithstanding subregulation (3), the authority may suspend any or all of the operations at an aerodrome pending receipt of a response from the holder.

(5) A holder of an aerodrome certificate who is aggrieved by the suspension of a certificate may appeal against the suspension to the director general of the authority within forty eight hours.

(6) A holder of an aerodrome certificate who is aggrieved by the suspension of a certificate may appeal against the suspension to the Appeals Tribunal, within fourteen days of the suspension.

(7) Where an appeal is made under subregulations (5) or (6), the holder of the aerodrome certificate shall state in writing the reasons why in his or her opinion, the suspension should be varied or set aside.

(8) Where a holder of an aerodrome certificate does not appeal against the suspension in accordance with subregulations (5) or (6).

(9) The holder of the aerodrome certificate which is suspended shall within thirty days of the suspension, surrender the aerodrome certificate to the authority.

(10) Notwithstanding subregulation (2), where an aerodrome certificate is suspended for a period of less than thirty days, the holder of the aerodrome certificate shall immediately surrender the aerodrome certificate to the authority.



#### **40. Cancellation of aerodrome certificate**

(1) The Authority may cancel an aerodrome certificate where—

- (a) the certificate holder is incapable or unwilling to carry out corrective action or has repeatedly committed serious violations;
- (b) the certificate holder has demonstrated a lack of responsibility, such as deliberate and flagrant acts of non-compliance or falsification of records jeopardising aviation safety;
- (c) the certificate holder has made it convincingly clear that the continued operation of the aerodrome will be detrimental to the public interest; or
- (d) the aerodrome operator surrenders the aerodrome certificate to the authority.

(2) A holder of an aerodrome certificate who is aggrieved with the cancellation of a certificate may appeal against the cancellation to the director general of the authority within forty eight hours from the date of cancellation.

(3) A holder of a certificate who is aggrieved by the cancellation of a certificate may appeal against the cancellation to the Appeals Tribunal, within fourteen days of the cancellation.

#### **41. Surrender of aerodrome certificate**

(1) Subject to subregulation (2), a holder of an aerodrome certificate may at any time surrender the aerodrome certificate to the authority.

(2) A holder of an aerodrome certificate who wishes to surrender the aerodrome certificate shall give the authority not less than sixty days notice in writing, before the date on which the certificate is to be surrendered.

(3) The authority shall cancel the aerodrome certificate upon the expiry of the period of the notice in subregulation (2).

(4) Where, after the expiry of the period in subregulation (2), an aerodrome is abandoned or is not maintained in accordance with the conditions of the aerodrome certificate, the holder of the aerodrome certificate shall remove, obliterate or modify the prescribed markings referred to in regulation 231(6).

#### **42. Charges and fines at certificated aerodromes**

(1) A holder of an aerodrome certificate shall prescribe charges for the use of the aerodrome or of any facilities provided at the aerodrome for the safety, security, efficiency or regularity of air navigation.

(2) A holder of an aerodrome certificate, where required by the authority, shall furnish particulars of the charges levied for the use of an aerodrome or the performance of services at the aerodrome.

(3) Notwithstanding subregulation (1), the authority may where necessary, prescribe the maximum charges which may be levied for the use of an aerodrome or the performance of services at the aerodrome, for a specified period.

(4) A holder of an aerodrome certificate for which the authority prescribes charges under subregulation (3) shall not cause or permit any charges to be made in contravention of that subregulation.

(5) A holder of an aerodrome certificate for which the authority prescribes charges shall cause the prescribed charges to be posted in a conspicuous place at the aerodrome.

#### **43. Register of aerodrome certificates**

(1) The authority shall maintain a register of all aerodrome certificates issued in accordance with these Regulations.

- (2) The register shall contain —
  - (a) the full name of the holder of the aerodrome certificate;
  - (b) the nationality of the holder of the aerodrome certificate;
  - (c) the postal, telephone, facsimile and e-mail addresses of the holder of the aerodrome certificate;
  - (d) the name and location of the aerodrome for which an aerodrome certificate is issued;
  - (e) the number of the aerodrome certificate;
  - (f) the date of issue and date of expiry of the certificate; and
  - (g) any other relevant information.

#### PART V—OBLIGATIONS OF AERODROME OPERATOR

#### **44. Compliance with regulations and conditions**

An aerodrome operator shall comply with these Regulations, the conditions endorsed on the aerodrome certificate or licence granted under these Regulations and any other condition that may be set by the authority.

#### **45. Competence of operational and maintenance personnel**

(1) An aerodrome operator shall see to it that there is an adequate number of qualified and skilled personnel to perform activities for the operations and maintenance of the aerodrome.

(2) Where the authority or any other relevant authority requires competence certification for the personnel of an aerodrome, the operator shall employ only those persons with the required competence certification.

(3) An aerodrome operator shall establish and implement a training programme to upgrade the competency of the personnel referred to in subregulation (1).

(4) The provisions of subregulation (3) shall apply to aerodromes in Category A.

#### **46. Aerodrome operations and maintenance**

(1) Subject to any directives that the authority may issue, an aerodrome operator shall operate and maintain the aerodrome in accordance with the procedures set out in the aerodrome manual.

(2) The authority may give written directives to an aerodrome operator to alter the procedures set out in an aerodrome manual.

(3) An aerodrome operator shall ensure proper and efficient maintenance of the aerodrome facilities.

(4) Where air traffic services are provided at an aerodrome, the aerodrome operator shall coordinate with the air traffic services, to ensure the safety of all aircraft operating in the airspace, associated with the aerodrome.

(5) The coordination mentioned in subregulation (4) shall cover other areas related to safety including aeronautical meteorological authorities and security.

#### **47. Safety management system**

(1) An aerodrome operator shall establish a safety management system that complies with the requirements specified in the Civil Aviation (Safety Management) Regulations, 2022 and any other requirements prescribed by the authority.

(2) The aerodrome operator shall require all users of the aerodrome, including ground-handling agencies and other organisations that perform activities independently at the aerodrome in relation to flight or aircraft handling, to comply with the requirements laid down by the aerodrome operator with regard to safety at the aerodrome and the aerodrome operator shall monitor such compliance.

(3) The aerodrome operator shall require all users of the aerodrome, including ground-handling agencies and other organisations to cooperate in the programme to promote safety at and the safe use of the aerodrome by immediately informing the aerodrome operator of any accidents, incidents, defects or faults which have a bearing on safety.

(4) An aerodrome operator shall establish a Runway Safety Team at the aerodrome in accordance with the guidelines provided by the authority.

(5) The established runway safety team shall implement an action plan for runway safety and advise aerodrome management as appropriate on potential runway safety issues and recommend strategies for hazard removal and mitigation of the identified risk.

(6) This regulation shall apply to all aerodromes in Categories A and B.

#### **48. Internal safety audits and safety reporting of aerodrome operator**

(1) The aerodrome operator shall audit the safety management system, including inspection of the aerodrome facilities, equipment and the aerodrome operator's own functions.

(2) The aerodrome operator shall audit and inspect other aerodrome users, including fixed-base operators, ground handling agencies and other organisations working at the aerodrome referred to in regulation 47(2).

#### **49. Storage of inflammable and other dangerous goods**

A person shall not store fuel, pyrotechnic materials and other highly inflammable or dangerous goods at an aerodrome except with the permission of aerodrome operator or the authority and in accordance with the laws.

**50. Safety measures against fire**

- (1) A person shall not—
  - (a) smoke within any place or bring an open flame into any place, where that act is prohibited;
  - (b) smoke or cause any open flame within the vicinity of an aircraft or of any vehicle used for the supply of fuel to an aircraft or a store, dump, liquid fuel or explosives;
  - (c) willfully give a false fire alarm;
  - (d) tamper or interfere with any fire hose reel, hydrant or any other item of equipment provided for fire-fighting purposes;
  - (e) keep, store, discard or discharge any flammable liquid, gas, signal flares or other like material in an aircraft, except in the receptacle appropriate for the purpose or in a place on the aerodrome specifically approved by the aerodrome operator for the purpose; or
  - (f) store, stack or use any material or equipment in a manner which constitutes or is likely to constitute a fire hazard.

(2) An aerodrome operator shall display appropriate signage in respect of the acts prohibited under subregulation (1) in conspicuous places at the aerodrome.

**51. Access to and operations within restricted areas**

(1) A person shall not access a restricted area of an aerodrome unless authorised by the aerodrome operator and subject to such conditions as the aerodrome operator may impose.

(2) A person authorised to access a restricted area under subregulation (1) shall not—

- (a) move an aircraft or a vehicle in the restricted area except with the permission and directions issued by the air traffic services personnel;
- (b) move an aircraft or vehicle in the restricted area in a manner that endangers the safety of persons and property;  
or
- (c) use a portion of the aerodrome for landing or taking off, other than the area designated for that purpose.

**52. Entry into or exit from restricted areas of aerodrome**

(1) A person, aircraft or vehicle shall not enter or leave a restricted area of an aerodrome except through points established by the aerodrome operator for that purpose.

(2) Except in an emergency or at an appropriate point of entry or exit established by an aerodrome operator for that purpose, a person—

- (a) other than a person carried in an aircraft or in a vehicle, shall not enter or leave a restricted area of an aerodrome;  
or
- (b) shall not move an aircraft on the surface of an aerodrome or a vehicle into or from the restricted area of an aerodrome.

**53. Test-running of aircraft engine**

A person shall not test-run an aircraft engine at an aerodrome except at the approved aircraft maintenance facility of the aerodrome or a place designated for that purpose, by the aerodrome operator.

**54. Removal of obstructions from aerodrome movement surface**

An aerodrome operator shall remove from the aerodrome surface any vehicle or other obstruction that is likely to be hazardous to aircraft operations.

## **55. Maintenance of environment management programme**

(1) An aerodrome operator shall establish and maintain an aerodrome environment management programme for the area within the control of the aerodrome operator and for the area where any wildlife presents or is likely to present a hazard to aircraft operations.

(2) An aerodrome operator shall ensure that the environment management programme established under subregulation (1) minimises the effects of any hazards or potential hazards taking into account the provisions of the laws on environmental management.

(3) This regulation shall not apply to aerodromes in Category C.

## **56. Protection of navigation aids**

An aerodrome operator shall in consultation with the authority—

- (a) prevent construction of any facilities on the aerodrome, which may adversely affect the operation of any electronic or visual navigation or air traffic service facility on the aerodrome; or
- (b) as far as it is within the control of the aerodrome operator, prevent any interruption of visual or electronic signal of navigation aids.

## **57. Responsibilities of aerodrome operator**

An aerodrome operator shall—

- (a) maintain the aerodrome in a serviceable condition;
- (b) keep the aerodrome free of unauthorised persons, vehicles and animals which are not under proper control or any other obstructions;
- (c) mark all obstructions in accordance with Part XII of these Regulations;
- (d) inform the authority of any alterations to obstructions or works on the aerodrome;



- (e) install approved wind direction indicators to show the surface direction of the wind and ensure that they function satisfactorily;
- (f) maintain the prescribed markings in a conspicuous place and ensure that they are readily visible to aircraft in the air or manoeuvring on the ground;
- (g) avail facilities and ensure that they are in serviceable condition and that all apparatus installed function efficiently;
- (h) appropriately mark the unserviceable areas on the landing terrain;
- (i) inform the authority where the aerodrome becomes unserviceable through any cause or where any portion of the surface of the landing area deteriorates to such an extent that the safe operation of aircraft may be endangered;
- (j) submit to the authority reports on the condition of the aerodrome as required by the authority;
- (k) ensure that all organisations performing activities at the aerodrome comply with safety requirements specified by the aerodrome operator;
- (l) report all incidents and accidents at the aerodrome to the authority; and
- (m) provide reports of all tests and exercises at the request of the authority.

**58. Inspection of aerodromes and unhindered access by inspectors of authority**

- (1) The authority shall—
  - (a) inspect and carry out tests on the aerodrome facilities, services and equipment; and
  - (b) inspect the documents and records of the aerodrome, where applicable, verify the safety management system of

the aerodrome, before an aerodrome licence or certificate is issued or renewed and subsequently, at any other time, for the purposes of ensuring that safety at the aerodrome is maintained.

(2) The authority shall inspect the aerodrome and associated facilities for the purpose of ensuring compliance with the applicable standards before the authority issues or renews an aerodrome certificate or licence.

(3) An inspector of the authority shall have unhindered access to any part of the aerodrome or any aerodrome facility, including equipment, records, documents and personnel for the purpose of facilitating the functions of the authority specified in subregulations (1) and (2).

## **59. Notifying and reporting**

(1) An aerodrome operator shall notify and report to the authority, the air traffic control unit and pilots, within the specified time limits, information relating to—

- (a) any inaccuracies in the Aeronautical Information Publication;
- (b) any changes to the aerodrome facilities, equipment and level of service planned in advance; and
- (c) issues that may require immediate notification including obstacles, obstructions and hazards, levels of service, movement areas and any other condition that affects aviation safety at the aerodrome and against which precautions are warranted.

(2) Where it is not feasible for an aerodrome operator to arrange for the air traffic control and the flight operations unit to receive notice of the developments referred to in subregulation (1) (c), the aerodrome operator shall immediately notify the pilots who may be affected by those developments.

## **60. Aerodrome movement area inspections**

(1) An aerodrome operator shall carry out inspections of the movement area as often as is necessary according to wildlife, weather conditions and traffic for aerodromes in Category A and B.

(2) An aerodrome operator shall carry out inspections of the movement area before each aircraft movement for aerodromes in Category C.

(3) The aerodrome operator, shall ensure that all inspections are carried out by qualified personnel.

## **61. Special inspections**

(1) An aerodrome operator shall inspect an aerodrome —

- (a) as soon as practicable after an accident or incident;
- (b) during any period of construction or repair of the aerodrome facilities or equipment that is critical to the safety of aircraft operations; and
- (c) at any other time when there are conditions at the aerodrome that may affect aviation safety.

(2) An aerodrome operator shall notify and report to the authority, within the specified time limits, information on any special inspection carried out under subregulation (1).

## **62. Warning notices**

Where a low flying aircraft, at or near an aerodrome, or where a taxiing aircraft, is likely to be hazardous to people or vehicles, an aerodrome operator shall —

- (a) post hazard warning notices to that effect, on any public way that is adjacent to the maneuvering area; or
- (b) where the public way is not controlled by the aerodrome operator, inform the relevant authority of the potential hazard.

**63. Requirements for aerodrome manual**

(1) An applicant for an aerodrome licence or certificate shall submit to the authority an aerodrome manual for approval upon making an application for a licence or a certificate.

(2) An aerodrome manual shall—

(a) be typewritten or printed;

(b) be signed by the aerodrome operator;

(c) be in a format that is easy to revise;

(d) have a system for recording the current pages and any amendments, including a page for logging revisions; and

(e) be organised in a manner that facilitates the preparation, review and approval processes.

(3) An aerodrome operator shall keep at least one approved copy of the aerodrome manual at the aerodrome and one copy at the principal place of business of the operator, where the place of business is different from the aerodrome.

(4) An aerodrome operator shall provide every member of the airside operating staff with a copy of the aerodrome manual or part of the aerodrome manual relevant to their operations.

(5) Where an aerodrome operator of an aerodrome in Category C is unable to keep a copy of the aerodrome manual at the aerodrome operator shall keep the aerodrome manual at a place authorised by the authority.

(6) The aerodrome operator shall make available the copy of the aerodrome manual for inspection by the authorised personnel.

#### **64. Information to be included in aerodrome manual**

(1) An aerodrome manual shall contain all the information and instructions necessary to enable the personnel of an aerodrome perform their duties.

(2) Notwithstanding subregulation (1), and to the extent that the particulars are applicable, a manual for an aerodrome in Category A, B or C shall include all pertinent information on the aerodrome's site, facilities, services, equipment, operating procedures, organisation and management including a safety management system as set out in Schedule 1.

(3) Where a person is given an exemption in accordance with Part XVII of these Regulations, the aerodrome manual shall show the exemption notice number given in respect of the exemption by the authority, the date when the exemption came into effect and the conditions or procedures of the exemption if any.

#### **65. Amendment of aerodrome manual**

(1) For the purposes of maintaining the accuracy of the information in an aerodrome manual —

- (a) an aerodrome operator shall whenever necessary, amend the aerodrome manual; or
- (b) the authority may issue a written directive requiring the aerodrome operator to alter or amend the aerodrome manual.

(2) Notwithstanding subregulation (1), an aerodrome operator shall submit the proposed amendment to the authority for approval, before the aerodrome manual is amended.

(3) The authority shall approve the amendment made to an aerodrome manual where the amendment meets the requirements of these Regulations.

## PART VII—AERODROME DATA

### **66. Aeronautical data**

(1) An aerodrome operator shall determine and report aerodrome related aeronautical data in accordance with the accuracy and integrity classification required to meet the needs of the end users of the aeronautical data.

(2) An aerodrome operator for an aerodrome in Category A shall make available to the aeronautical information services aerodrome, mapping data where safety and performance based operations suggest possible benefits.

(3) Where aerodrome mapping data is made available in accordance with subregulation (2), the selection of the aerodrome mapping data features to be collected, shall be made with consideration of the intended application.

(4) The digital data error detection techniques shall be used during the transmission and storage of aeronautical data and digital data sets.

### **67. Aerodrome reference point**

(1) An aerodrome reference point shall be established for every aerodrome.

(2) The aerodrome reference point shall be located near the initial or planned geometric center of the aerodrome and shall remain where first established.

(3) The position of the aerodrome reference point shall be measured and reported to the Aeronautical Information Services in degrees, minutes and seconds.

### **68. Aerodrome and runway elevation**

(1) The aerodrome elevation and geoid undulation at the aerodrome elevation position shall be measured to the accuracy of one foot and reported to the Aeronautical Information Services.

(2) In the case of an aerodrome used by international civil aviation for non-precision approaches, the elevation and geoid undulation of each threshold, the elevation of the runway end and any significant high and low intermediate points along the runway shall be measured to the accuracy of one foot and reported to the Aeronautical Information Services.

(3) In the case of a precision approach runway, the elevation and geoid undulation of the threshold, the elevation of the runway end and the highest elevation of the touchdown zone shall be measured to the accuracy of one foot and reported to the Aeronautical Information Services.

(4) The geoid undulation shall be measured in accordance with the appropriate system of coordinates.

#### **69. Aerodrome reference temperature**

(1) An aerodrome operator shall determine the aerodrome reference temperature for the respective aerodrome in degrees Celsius.

(2) The aerodrome reference temperature shall be the monthly mean of the daily maximum temperatures for the hottest month of the year, the hottest month being that which has the highest monthly mean temperature, and this temperature shall, where possible be averaged over a period of years.

(3) The aerodrome reference temperature shall where possible, be averaged over a period of years.

#### **70. Aerodrome dimensions and related information**

(1) The following data shall be measured or described, as appropriate, for each facility provided at an aerodrome—

- (a) runway - true bearing to one-hundredth of a degree, designation number, length, width, displaced threshold location to the nearest meter, slope, surface type, type of runway and, for a precision approach runway Category I, the existence of an obstacle free zone when provided for a runway;

- (b) length and width to the nearest meter, surface type of the runway strip, runway end, safety area and stopway;
- (c) location and description of the arresting system for the respective runway end;
- (d) the designation, width and surface type for taxiways;
- (e) surface type and aircraft stands for aprons;
- (f) the boundaries of the air traffic control service;
- (g) length to the nearest meter and ground profile for clearway;
- (h) visual aids for approach procedures, marking and lighting of runways, taxiways and aprons, other visual guidance and control aids on taxiways and aprons, including taxi-holding positions and stopbars, and location and type of visual docking guidance systems;
- (i) location and radio frequency of any VOR aerodrome checkpoint;
- (j) location and designation of standard taxi-routes; and
- (k) distances to the nearest meter of localizer and glide path elements comprising an ILS or azimuth in relation to the associated runway extremities.

(2) The geographical coordinates of each threshold shall be measured and reported to the aeronautical information services in degrees, minutes, seconds and hundredths of seconds.

(3) The geographical coordinates of the appropriate taxiway center line points shall be measured and reported to the Aeronautical Information Services in degrees, minutes, seconds and hundredths of seconds.



(4) The geographical coordinates of each aircraft stand shall be measured and reported to the Aeronautical Information Services in degrees, minutes, seconds and hundredths of seconds.

(5) The geographical coordinates of obstacles in Area 2, the part within the aerodrome boundary and in Area 3 shall be measured and reported to the aeronautical information services in degrees, minutes, seconds and tenths of seconds.

(6) In addition to the coordinates in subregulation (5), the top elevation, type, marking and lighting, if any, of obstacles shall be reported to the Aeronautical Information Services.

(7) The requirements for obstacle data determination in Area 2 and Area 3 referred to in subregulation (5) shall comply with the provisions of the Civil Aviation (Aeronautical Information Services) Regulations, 2022.

## **71. Strength of pavements**

(1) This regulation shall remain in force until the 27th November 2024.

(2) The aerodrome operator shall determine the bearing strength of all pavements.

(3) The bearing strength of a pavement intended for aircraft of apron mass greater than 5,700kg shall be made available using the Aircraft Classification Number-Pavement Classification Number (ACN-PCN) method by reporting all of the following information—

- (a) Pavement Classification Number (PCN);
- (b) pavement type for ACN-PCN determination;
- (c) subgrade strength category;
- (d) maximum allowable tyre pressure category or maximum allowable tyre pressure value; and
- (e) evaluation method.

(4) The PCN reported shall indicate that an aircraft with an ACN equal to or less than the reported PCN can operate on the pavement subject to any limitation on the tyre pressure, or aircraft all-up mass for specified aircraft type.

(5) The ACN of an aircraft shall be determined in accordance with the standard procedures associated with the ACN-PCN method.

(6) For the purposes of determining the ACN, the behaviour of a pavement shall be classified as equivalent to a rigid or flexible construction.

(7) Information on pavement type for ACN-PCN determination, subgrade strength category, maximum allowable tyre pressure category and evaluation method shall be reported using the following codes—

- |       |  |             |
|-------|--|-------------|
| (a)   | <i>Pavement type for ACN-PCN determination:</i>  | <i>Code</i> |
| (i)   | Rigid pavement   | R           |
| (ii)  | Flexible pavement  | F           |
| (b)   | <i>Subgrade strength category:</i>   | <i>Code</i> |
| (i)   | <i>High strength:</i> characterised by $K = 150 \text{ MN/m}^3$ and representing all $K$ values above $120 \text{ MN/m}^3$ for rigid pavements and by $\text{CBR} = 15$ and representing all $\text{CBR}$ values above 13 for flexible pavements.        | <i>A</i>    |
| (ii)  | <i>Medium strength:</i> characterised by $K = 80 \text{ MN/m}^3$ and representing a range in $K$ of 60 to $120 \text{ MN/m}^3$ for rigid pavements, and by $\text{CBR} = 10$ and representing a range in $\text{CBR}$ of 8 to 13 for flexible pavements; | <i>B</i>    |
| (iii) | <i>Low strength:</i> characterised by $K = 40 \text{ MN/m}^3$ and representing a range in $K$ of 25 to $60 \text{ MN/m}^3$ for rigid pavements, and by $\text{CBR} = 6$ and representing a range in $\text{CBR}$ of 4 to 8 for flexible pavements;       | <i>C</i>    |

- (iv) *Ultra low strength*: characterised by  $K = 20 \text{ MN/m}^3$  and representing all  $K$  values below  $25 \text{ MN/m}^3$  for rigid pavements and by  $\text{CBR} = 3$  and representing all  $\text{CBR}$  values below 4 for flexible pavements; *D*
  
- (c) *Maximum allowable tyre pressure category*: *Code*
  - (i) *Unlimited*: no pressure limit *W*
  - (ii) *High*: pressure limited to  $1.75 \text{ MPa}$  *X*
  - (iii) *Medium*: pressure limited to  $1.25 \text{ MPa}$  *Y*
  - (iv) *Low*: pressure limited to  $0.50 \text{ MPa}$  *Z*
  
- (d) *Evaluation method*: *Code*
  - (i) *Technical evaluation*: representing a specific study of the pavement characteristics and application of pavement behaviour technology; and *T*
  - (ii) *Using aircraft experience*: representing a knowledge of the specific type and mass of aircraft satisfactorily being supported under regular use. *U*

(8) The following examples shall be used to illustrate how pavement strength data is reported under the ACN-PCN method—

- (a) where the bearing strength of a rigid pavement, resting on a medium strength subgrade, has been assessed by technical evaluation to be PCN 80 and there is no tyre pressure limitation, then the information shall be reported as—

PCN 80 / R / B / W / T ;

- (b) where the bearing strength of a composite pavement, behaving like a flexible pavement and resting on a high strength subgrade, has been assessed by using aircraft experience to be PCN 50 and the maximum tyre pressure allowable is 1.25 MPa, then the information shall be reported as—

PCN 50 / F / A / Y / U;

- (c) where the bearing strength of a flexible pavement, resting on a medium strength subgrade, has been assessed by technical evaluation to be PCN 40 and the maximum allowable tyre pressure is 0.80 MPa, then the information shall be reported as—

PCN 40 / F / B / 0.80 MPa / T; and

- (d) where a pavement is subject to a B747-400 all-up mass limitation of 390,000kg, then the information reported shall include a note to the effect that the reported PCN is subject to a B747- 400 all-up mass limitation of 390,000kg.

(9) An aerodrome operator shall establish a criteria to be used to regulate the use of a pavement by an aircraft with an ACN higher than the PCN reported for that pavement in accordance with subregulations (3) and (4).

(10) The bearing strength of a pavement intended for aircraft of apron mass equal to or less than 5,700kg shall be made available by reporting the—

- (a) maximum allowable aircraft mass; and
- (b) maximum allowable tyre pressure.

(11) Notwithstanding subregulation (9) where operations in which the magnitude of overload or the frequency of use do not justify a detailed analysis, the following criteria shall be used—

- (a) for flexible pavements, occasional movements by aircraft with ACN not exceeding 10 percent above the reported PCN shall not adversely affect the pavement;
- (b) for rigid or composite pavements, in which a rigid pavement layer provides a primary element of the structure, occasional movements by aircraft with ACN not exceeding 5 percent above the reported PCN shall not adversely affect the pavement;
- (c) where the pavement structure is unknown, the 5 percent limitation shall apply; and
- (d) the annual number of overload movements shall not exceed approximately 5 percent of the total annual aircraft movements.

(12) Overload movements shall not normally be permitted on pavements that exhibit signs of distress or failure.

(13) Overloading shall be avoided where the strength of the pavement or its subgrade could be weakened by water.

(14) Where overload operations are conducted, the aerodrome operator shall review the relevant pavement conditions regularly and review the criteria for overload operations periodically.

## **72. Strength of pavements**

(1) This regulation shall come into force on 28th November, 2024.

(2) The aerodrome operator shall determine the bearing strength of a pavement.

(3) The bearing strength of a pavement intended for aircraft of apron mass greater than 5,700 kg shall be made available using the Aircraft Classification Rating - Pavement Classification Rating (ACR-PCR) method by reporting the—

- (a) Pavement Classification Rating (PCR) and numerical value;

- (b) pavement type for ACR-PCR determination;
- (c) subgrade strength category;
- (d) maximum allowable tire pressure category or maximum allowable tire pressure value; and
- (e) evaluation method.

(4) The PCR reported shall indicate that an aircraft with an ACR equal to or less than the reported PCR can operate on the pavement subject to any limitation on the tire pressure, or aircraft all-up mass for specified aircraft type.

(5) The ACR of an aircraft shall be determined in accordance with the standard procedures associated with the ACR-PCR method.

(6) For the purposes of determining the ACR, the behaviour of a pavement shall be classified as equivalent to a rigid or flexible construction.

(7) Information on pavement type for ACR-PCR determination, subgrade strength category, maximum allowable tire pressure category and evaluation method shall be reported using the following codes—

- |      |   |             |
|------|---|-------------|
| (a)  | <i>Pavement type for ACR-PCR determination:</i>   | <i>Code</i> |
| (i)  | Rigid pavement  | R;          |
| (ii) | Flexible pavement   | F;          |
| (b)  | <i>Subgrade strength category:</i>  | <i>Code</i> |
| (i)  | <i>High strength:</i> characterised by E=200 MPa, and representing all E values equal to or above 150 MPa for rigid and flexible pavements; | A           |

- |       |  |             |
|-------|--|-------------|
| (ii)  | <i>Medium strength</i> : characterised by E=120 MPa and representing a range in E values equal to or above 100 MPa and strictly less than 150 MPa, for rigid and flexible pavements; | B           |
| (iii) | <i>Low strength</i> : characterised by E=80 MPa and representing a range in E values equal to or above 60 MPa and strictly less than 100 MPa, for rigid and flexible pavements;      | C           |
| (iv)  | <i>Ultra-low strength</i> : characterised by E=50 MPa and representing all E values strictly less than 60 MPa, for rigid and flexible pavements;                                     | D           |
| (c)   | <i>Maximum allowable tire pressure category</i> :  | <i>Code</i> |
| (i)   | <i>Unlimited</i> : no pressure limit   | W           |
| (ii)  | <i>High</i> : pressure limited to 1.75 MPa   | X           |
| (iii) | <i>Medium</i> : pressure limited to 1.25 MPa   | Y           |
| (iv)  | <i>Low</i> : pressure limited to 0.50 MPa  | Z           |
| (d)   | <i>Evaluation method</i> :   | <i>Code</i> |
| (i)   | <i>Technical evaluation</i> : representing a specific study of the pavement characteristics and the types of aircraft which the pavement is intended to serve; and                   | T           |
| (ii)  | <i>Using aircraft experience</i> : representing a knowledge of the specific type and mass of aircraft satisfactorily being supported under regular use.                              | U           |

(8) The following examples shall be used to illustrate how pavement strength data is reported under the ACR-PCR method—

- (a) If the bearing strength of a rigid pavement, resting on a medium strength subgrade, has been assessed by technical evaluation to be PCR 760 and there is no tire pressure limitation, then the information shall be reported as—

PCR 760/ R / B / W / T;

- (b) where the bearing strength of a composite pavement, behaving like a flexible pavement and resting on a high strength subgrade, has been assessed by using aircraft experience to be PCR 550 and the maximum tire pressure allowable is 1.25 MPa, then the information shall be reported as:

PCR 550 / F / A / Y / U;

(9) An aerodrome operator shall establish a criteria to be used to regulate the use of a pavement by an aircraft with an ACR higher than the PCR reported for that pavement in accordance with subregulations (3) and (4).

(10) The bearing strength of a pavement intended for aircraft of apron mass equal to or less than 5,700kg shall be made available by reporting the—

- (a) maximum allowable aircraft mass; and
- (b) maximum allowable tire pressure.

(11) For those operations in which magnitude of overload or the frequency of use do not justify a detailed analysis, the following criteria shall be used—

- (a) for flexible and rigid pavements, occasional movements by aircraft with ACR not exceeding 10 percent above the reported PCR shall not adversely affect the pavement;
- (b) the annual number of overload movements shall not exceed approximately 5 percent of the total annual movements, excluding light aircraft.

(12) Overload movements shall not normally be permitted on pavements exhibiting signs of distress or failure.

(13) Overloading shall be avoided where the strength of the pavement or its subgrade could be weakened by water.



(14) Where overload operations are conducted, the aerodrome operator shall review the relevant pavement condition regularly and the criteria for overload operations periodically.

**73. Pre-flight altimeter check location**

(1) One or more pre-flight altimeter check locations shall be established for an aerodrome.

(2) A pre-flight check location shall be located on an apron to enable an altimeter check to be made prior to obtaining taxi clearance and to eliminate the need for stopping for that purpose after leaving the apron, in which case, an entire apron shall serve as a satisfactory altimeter check location.

(3) The elevation of a pre-flight altimeter check location shall be given as the average elevation, rounded to the nearest foot, of the area on which it is located.

(4) The elevation of any portion of a pre-flight altimeter check location shall be within 10ft of the average elevation for that location.

**74. Declared distances**

(1) The following distances shall be calculated to the nearest meter for a runway intended for use by international commercial air transport—

- (a) Take-Off Run Available (TORA);
- (b) Take-Off Distance Available (TODA);
- (c) Accelerate-Stop Distance Available (ASDA); and
- (d) Landing Distance Available (LDA).

(2) The declared distances shall be calculated in accordance with Schedule 8 to these Regulations.

**75. Condition of movement area and related facilities**

(1) Information on the condition of the movement area and the operational status of related facilities shall be—

- (a) provided to the appropriate aeronautical information services units, and similar information of operational significance to the air traffic services units, to enable those units provide the necessary information to arriving and departing aircrafts; and
- (b) kept up to date and changes in the condition shall be reported without delay.

(2) The condition of the movement area and the operational status of related facilities shall be monitored and reports on matters of operational significance affecting aircraft and aerodrome operations shall be provided in order to take appropriate action, particularly in respect of—

- (a) construction or maintenance work;
- (b) rough or broken surfaces on a runway, a taxiway or an apron;
- (c) water on a runway, a taxiway or an apron;
- (d) other contaminants on a runway, taxiway or apron including mud, dust, sand, volcanic ash, oil and rubber;
- (e) other temporary hazards, including parked aircraft;
- (f) failure or irregular operation of part or all of the aerodrome visual aids;
- (g) failure of the normal or secondary power supply;
- (h) changes in the availability of the manoeuvring area and changes in the runway declared distance; except that increases in declared distances may only be made with the approval of the authority;

- (i) interruption, return to service, or major changes to rescue facilities and fire-fighting services in terms of the new category of the rescue and fire-fighting service available at the aerodrome; except that permanent changes to the promulgated rescue fire-fighting category may only be made with the approval of the authority;
- (j) failure of or return to operation of hazard beacons and obstruction lights in the vicinity of the aerodrome; and
- (k) any other information of operational significance.

(3) For the purposes of facilitating compliance with subregulations (1) and (2), the following inspections shall be carried out on a daily basis—

- (a) in the case of the movement area, once a day where the aerodrome reference code number is 1 or 2 and not less than two times a day where the aerodrome reference code number is 3 or 4; and
- (b) in the case of a runway, inspections in addition to paragraph (a) where the runway surface conditions may have changed significantly due to meteorological conditions.

(4) The personnel assessing and reporting the runway surface conditions referred to in subregulation (2) and in regulation 76(1) shall be trained and competent to perform their duties.

## **76. Runway surface condition for use in runway condition report**

(1) The runway surface condition shall be assessed and reported through a Runway Condition Code (RWYCC) and a description using the following terms—

DRY

STANDING WATER

WET

LOOSE SAND

(2) Whenever an operational runway is contaminated, an assessment of the contaminant depth and coverage over every third of the runway shall be made and reported.

(3) The aerodrome operation shall provide the information that a runway or portion thereof is slippery and wet to aerodrome users.

(4) Notification shall be given to the relevant aerodrome users where the friction level of a paved runway or portion thereof is less than the minimum friction level specified in accordance with regulation 278(3).

(5) The information to be promulgated in a NOTAM shall include specifications of which portion of the runway is below the minimum friction level and its location on the runway.

#### **77. Disabled aircraft removal**

(1) An aerodrome operator shall on request of the aircraft operator make available the telephone number and email address of the office of the aerodrome coordinator responsible for removing an aircraft that is disabled on or adjacent to the movement area.

(2) The information concerning the capability to remove an aircraft that is disabled on or adjacent to the movement area shall be made available.

(3) The capability to remove a disabled aircraft may be expressed in terms of the largest type of aircraft which the aerodrome is equipped to remove.

#### **78. Information on rescue and fire-fighting**

(1) An aerodrome operator shall provide information concerning the level of protection provided at an aerodrome for aircraft rescue and fire-fighting purposes.

(2) The level of protection available at an aerodrome shall be expressed in terms of the category of the rescue and fire-fighting services and in accordance with the types and amounts of extinguishing agents ordinarily available at the aerodrome.

(3) Changes in the level of protection ordinarily available at an aerodrome for rescue and fire-fighting services, shall be notified to the appropriate air traffic services units and aeronautical information services units, to enable those units provide the necessary information to arriving and departing aircrafts.

(4) Where the change referred to in subregulation (3) has been corrected, the appropriate air traffic services units and aeronautical information services units shall be advised accordingly.

(5) The change referred to in subregulation (3) shall be expressed in terms of the new category of the rescue and fire-fighting services available at the aerodrome.

## **79. Visual approach slope indicator system**

The aerodrome operator shall make available the following information concerning a visual approach slope indicator system installation—

- (a) the associated runway designation number;
- (b) the type of system in accordance with regulations 168(2), the side of the runway on which the lights are installed, that is left or right, shall be given for a PAPI or APAPI installation;
- (c) where the axis of the system is not parallel to the runway center line, the angle of displacement and the direction of displacement, that is left or right, shall be indicated;
- (d) nominal approach slope angle and for a PAPI or an APAPI this shall be angle  $(B + C) \div 2$  and  $(A + B) \div 2$ , respectively as set out in Figure 23; and

- (e) the minimum eye height over the threshold of the on-slope signal—
  - (i) for a PAPI shall be the setting angle of the third unit from the runway minus 2 minutes, that is angle B minus 2 minutes; and
  - (ii) for an APAPI shall be the setting angle of the unit farther from the runway minus 2 minutes, that is angle A minus 2 minutes.

**80. Coordination between aeronautical information services and aerodrome authorities**

(1) For the purposes of provision of the aeronautical services units with information to enable them provide up to date pre-flight information and to meet the need for inflight information, arrangements shall be made between Aeronautical Information Services (AIS) and aerodrome operator to report to the responsible AIS unit with minimum delay—

- (a) information on the status of certification of the aerodrome and the aerodrome conditions;
- (b) the operational status of associated facilities, services and navigation aids within their area of responsibility; and
- (c) any other information considered to be of operational significance.

(2) Before introducing changes to the air navigation system, due account shall be taken by the aerodrome operator or the authority responsible for the change, of the time needed by the aeronautical information services for the preparation, production and issue of the relevant material for promulgation.

(3) For purposes of timely provision of the information to AIS, aerodrome operator or the authority responsible for the changes referred to in subregulation (2) shall maintain close coordination with the aeronautical information services.

(4) The predetermined, internationally agreed Aeronautical Information Regulation and Control (AIRAC) effective dates shall be observed by the responsible aerodrome services when submitting the raw information or data, to aeronautical information services, especially changes to aeronautical information that affects charts and computer-based navigation systems which qualify to be notified by the AIRAC system as specified in the Civil Aviation (Aeronautical Information Services) Regulations, 2022.

(5) The aerodrome services responsible for the provision of raw aeronautical information or data to the AIS shall take into account the accuracy and integrity requirements required to meet the needs of the end user of the aeronautical data.

## PART VIII—AERODROME PHYSICAL CHARACTERISTICS

### **81. Conditions for operating aerodrome**

A person shall not operate an aerodrome licensed or certificated under these Regulations unless the facilities and characteristics of the aerodrome are effectively related and match the needs of the aircraft for which the aerodrome is intended.

### **82. Standards for physical characteristics of aerodrome**

A person shall not operate an aerodrome unless the physical characteristics of the aerodrome comply with these Regulations.

### **83. Number and orientation of runways**

(1) The number and orientation of runways at an aerodrome shall be such that the usability factor of the aerodrome is not less than 95 percent for the aeroplanes for which the aerodrome is intended to serve.

(2) The siting and orientation of runways at an aerodrome shall be such that the arrival and departure tracks minimise interference with areas approved for residential use and other noise-sensitive areas close to the aerodrome.

(3) Where a new instrument runway is being located, particular attention shall be given to areas over which aeroplanes will be required to fly when following instrument approach and missed approach procedures, so as to ensure that obstacles in these areas or other factors will not restrict the operation of the aeroplanes for which the runway is intended.

#### **84. Choice of maximum permissible cross-wind components**

(1) In determining the number and orientation of runways required in subregulation 83(1), the landing and take-off of aeroplanes shall be precluded where the crosswind component exceeds—

- (a) 20kt in the case of aeroplanes whose reference field length is 1500m or over, except that when poor runway braking action owing to an insufficient longitudinal coefficient of friction is experienced with some frequency, a crosswind component not exceeding 13kt shall be assumed;
- (b) 13kt in the case of aeroplanes whose reference field length is 1,200m or more but not including 1,500m; and
- (c) 10kt in the case of aeroplanes whose reference field length is less than 1,200m.

(2) Factors that may affect the calculation of the estimate of the usability factor and allowances to be made to take account of the effect of unusual circumstance shall include the—

- (a) type of operation;
- (b) climatological conditions including wind distribution, wind statistics and crosswind components;
- (c) topography of the aerodrome site, aircraft approach paths and surroundings including—
  - (i) compliance with obstacle limitation surfaces, where applicable;
  - (ii) current and future land use;



- (iii) construction costs;
- (iv) visual and non-visual aids for approach to land; and
- (d) air traffic in the vicinity of the aerodrome including—
  - (i) proximity of other aerodromes or air traffic services routes;
  - (ii) traffic density; and
  - (iii) air traffic control and missed approach procedures where applicable.

### **85. Data to be used for calculation of runway usability factor**

The selection of data to be used for the calculation of the runway usability factor shall be based on reliable wind distribution statistics that extend over a period of not less than five years with wind observations made not less than eight times daily and spaced at equal intervals of time.

### **86. Location of threshold**

(1) A threshold shall be located at the extremity of a runway unless operational considerations justify the choice of another location.

(2) Where it is necessary to displace a threshold, either permanently or temporarily, from its normal location, the aerodrome operator shall take into account the various factors which may have a bearing on the location of the threshold.

(3) Where a displacement is due to an unserviceable runway condition, a cleared and graded area of not less than 60m in length shall be available between the unserviceable area and the displaced threshold and an additional distance shall be provided to meet the requirements of the runway end safety area as appropriate.

(4) In accordance with subregulation (2), factors to be considered in the determination of the location of a displaced threshold shall be—

- (a) obstacles in the approach surface;

- (b) landing distance available;
- (c) type of aircraft for which the runway is intended;
- (d) visibility and cloud base conditions;
- (e) obstacle clearance limit in the case of precision approach runways; and
- (f) provision for obstacle free surfaces.

**87. Determination of actual length of runway**

(1) Notwithstanding subregulation (3), the actual runway length for a primary runway shall meet the operational requirements of the aeroplane for which the runway is intended and shall not be less than the longest length determined by applying the corrections for local conditions to the operations and performance characteristics of the relevant aeroplanes, including elevation, temperature, runway slope, humidity and the runway surface characteristics.

(2) The length of a secondary runway shall be determined in accordance with subregulation (1) except that it shall be adequate for those aeroplanes which require to use the secondary runway in addition to other runways in order to obtain a usability factor of at least 95 percent.

(3) Where a runway is associated with a stopway or clearway, an actual runway length less than that resulting from application of subregulations (1) or (2), as appropriate, may be considered satisfactory, but in such a case any combination of runway, stopway and clearway provided shall permit compliance with the operational requirements for take-off and landing of the aircraft the runway is intended to serve.

(4) The use of stopways and clearways shall be as set out in Schedule 8 to these Regulations.

**88. Determination of width of runway**

(1) The width of a runway shall not be less than the appropriate dimension specified in the following tabulation—

	<b>Outer Main Gear Wheel Span (OMGWS)</b>			
Code number	Up to but less 4.5m	4.5m up to but less than 6m	6m up to but less than 9m	9m up to but less than 15m
1a	18m	18m	23m	-
2a	23m	23m	30m	-
3	30m	30m	30m	45m
4	-		45m	45m

<sup>a</sup> The width of a precision approach runway shall not be less than 30m where the code number is 1 or 2.

(2) The width of a precision approach runway shall be not less than 30m where the code number is 1 or 2.

**89. Determination of minimum distance between parallel runways**

(1) Where parallel non-instrument runways are intended for simultaneous use, the minimum distance between their center lines shall be—

- (a) 210m where the higher code number is 3 or 4;
- (b) 150m where the higher code number is 2; and
- (c) 120m where the higher code number is 1.

(2) Where parallel instrument runways are intended for simultaneous use, the minimum distance between their center lines shall be—

- (a) 1,035m for independent parallel approaches;
  - (b) 915m for dependent parallel approaches;
  - (c) 760m for independent parallel departures; and
  - (d) 760m for segregated parallel operations.
- (3) Notwithstanding subregulation (2)—
- (a) for segregated parallel operations the specified minimum distance—
    - (i) may be decreased by 30m for each 150m that the arrival runway is staggered towards the arriving aircraft, to a minimum of 300m;
    - (ii) shall be increased by 30m for each 150m that the arrival runway is staggered away from the arriving aircraft; and
  - (b) in the case of independent parallel approaches, combinations of minimum distances and associated conditions may be applied when it is determined that such combinations would not adversely affect the safety of aircraft operations.

(4) Subject to subregulations (1), (2) and (3), an aerodrome operator shall in consultation with its service partners and users of the aerodrome, determine the operating parameters of design criteria contained in these Regulations and shall include in the aerodrome manual and any limitations of use of the facilities of the aerodrome.

(5) The aerodrome operator shall take account of the intended use and procedures for the aerodrome, including ATC (Air Traffic Control) procedures minimum separation distances between a runway, taxiway and a FATO (Final Approach and Take-off Area).

## 90. Slopes on runways

(1) The longitudinal slope of a runway shall be computed by dividing the difference between the maximum and minimum elevation along the runway center line by the runway length and shall not exceed—

- (a) 1 percent where the code number is 3 or 4; and
- (b) 2 percent where the code number is 1 or 2.

(2) The longitudinal slopes along any portion of a runway shall not exceed—

- (a) 1.25 percent where the code number is 4, except that for the first and last quarter of the length of the runway the longitudinal slope shall not exceed 0.8 percent;
- (b) 1.5 percent where the code number is 3, except that for the first and last quarter of the length of a precision approach runway Category II or III the longitudinal slope shall not exceed 0.8 percent; and
- (c) 2 percent where the code number is 1 or 2.

(3) Where longitudinal slope changes cannot be avoided, the slope change between two consecutive slopes shall not exceed—

- (a) 1.5 percent where the code number is 3 or 4; and
- (b) 2 percent where the code number is 1 or 2.

(4) The transition from one slope to another shall be accomplished by a curved surface with a rate of change not exceeding—

- (a) 0.1 percent per 30m (minimum radius of curvature of 30,000m) where the code number is 4;
- (b) 0.2 percent per 30m (minimum radius of curvature of 15,000m) where the code number is 3; and

(c) 0.4 percent per 30m (minimum radius of curvature of 7,500m) where the code number is 1 or 2.

(5) Where longitudinal slope changes cannot be avoided, the slopes shall be such that there will be an unobstructed line of sight from—

(a) any point 3m above a runway to all other points 3 m above the runway within a distance of not less than half the length of the runway where the code letter is C, D, E or F;

(b) any point 2m above a runway to all other points 2m above the runway within a distance of not less than half the length of the runway where the code letter is B; and

(c) any point 1.5m above a runway to all other points 1.5m above the runway within a distance of not less than half the length of the runway where the code letter is A;

(6) Consideration shall be given to providing an unobstructed line of sight over the entire length of a single runway where a full-length parallel taxiway is not available and where an aerodrome has intersecting runways, additional criteria on the line of sight of the intersection area shall be considered for operational safety.

(7) Undulations or appreciable changes in slopes located close together along a runway shall be avoided and the distance between the points of intersection of two successive curves shall not be less than—

(a) the sum of the absolute numerical values of the corresponding slope changes multiplied by the appropriate value as follows—

(i) 30,000m where the code number is 4;

(ii) 15,000m where the code number is 3; and

(iii) 5,000m where the code number is 1 or 2; or

(b) 45 m; whichever is greater.

(8) To promote the most rapid drainage of water, the runway surface shall, be cambered except where a single crossfall from high to low in the direction of the wind most frequently associated with rain would ensure rapid drainage.

(9) The transverse slope shall where possible, be—

(a) 1.5 percent where the code letter is C, D, E or F; and

(b) 2 percent where the code letter is A or B,

but in any event shall not exceed 1.5 percent or 2 percent, as applicable, nor be less than 1 percent except at runway or taxiway intersections where flatter slopes may be necessary.

(10) For a cambered surface, the transverse slope on each side of the center line shall be symmetrical.

(11) The transverse slope shall be substantially the same throughout the length of a runway except at an intersection with another runway or a taxiway where an even transition shall be provided taking into account the need for adequate drainage.

## **91. Strength of runways**

A runway shall be capable of withstanding the traffic of aeroplanes that it is intended to serve.

## **92. Surface of runways**

(1) The surface of a runway shall be constructed without irregularities that would impair the runway surface friction characteristics or otherwise adversely affect the take-off or landing of an aeroplane.

(2) A paved runway shall be constructed or resurfaced to provide surface friction characteristics at or above the minimum friction level specified in Regulation 278(3).

(3) The surface of a paved runway shall be evaluated when constructed or resurfaced to determine that the surface friction characteristics achieve the design objectives.

(4) The measurements of the surface friction characteristics of a new or resurfaced paved runway shall be made with a continuous friction measuring device using self-wetting features.

(5) The average surface texture depth of a new surface shall be not less than 1.0 mm, taking into consideration macrotexture and microtexture in order to provide the required surface friction characteristics.

(6) Where the surface is grooved or scored, the grooves or scorings shall be either perpendicular to the runway center line or parallel to non-perpendicular transverse joints, where applicable.

### **93. Runway shoulders**

(1) Runway shoulders shall be provided for a runway where the code letter is D, E or F.

(2) For earoplanes with OMGWS ranging from 9m up to but not including 15m, the runway shoulders shall extend symmetrically on each side of the runway so that the overall width of the runway and its shoulders is not less than —

- (a) 60m where the code letter is D or E;
- (b) 60m where the code letter is F for two or three-engined aeroplanes; and
- (c) 75m where the code letter is F for four (or more)-engined aeroplanes.

(3) The surface of the shoulder that abuts the runway shall be flush with the surface of the runway and its transverse slope shall not exceed 2.5 percent.

(4) The portion of a runway shoulder between the runway edge and a distance of 30 m from the runway center line shall be prepared or constructed so as to be capable, in the event of an aeroplane running off the runway, of supporting the aeroplane without inducing structural damage to the aeroplane and of supporting ground vehicles which may operate on the shoulder.



(5) A runway shoulder shall be prepared or constructed so as to resist erosion and the ingestion of the surface material by aeroplane engines.

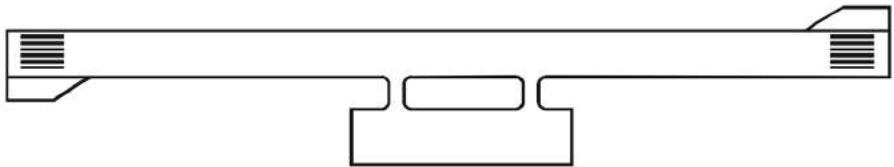
(6) The runway shoulders for code letter F aeroplanes shall be paved to a minimum overall width of runway and shoulder of not less than 60m.

**94. Runway turn pads**

(1) Where the end of a runway is not served by a taxiway or a taxiway turnaround, a runway turn pad shall be provided to facilitate a 180-degree turn of aeroplanes, as set out in figure 1.

*Figure 1. Typical turn pad layout*

---



---

(2) The runway turn pad may be located on either the left or right side of the runway and adjoining the runway pavement at both ends of the runway and at some intermediate locations where deemed necessary.

(3) The intersection angle of the runway turn pad with the runway shall not exceed 30 degrees.

(4) The nose wheel steering angle to be used in the design of the runway turn pad shall not exceed 45 degrees.

(5) The design of a runway turn pad shall be such that, when the cockpit of the aeroplane for which the turn pad is intended remains over the turn pad marking, the clearance distance between any wheel of the aeroplane landing gear and the edge of the turn pad shall be not less than that given by the following tabulation—

OMGWS (Outer Main Gear Wheel Span)				
	Up to but not includ- ing 4.5m	4.5m up to but not including 6m	6m up to but not including 9m	9m up to but not includ- ing 15m
Clearance	1.50m	2.25m	3m <sup>a</sup> or 4m <sup>b</sup>	4m
<sup>a</sup> where the turn pad is intended to be used by aeroplanes with wheel base less than 18m <sup>b</sup> where the turn pad is intended to be used by aeroplanes with a wheel base equal to or greater than 18m				

(6) The longitudinal and transverse slopes on a runway turn pad shall be sufficient to prevent the accumulation of water on the surface and facilitate rapid drainage of surface water and shall be the same as those on the adjacent runway pavement surface.

(7) The strength of a runway turn pad shall not be less than that of the adjoining runway which it serves and due consideration shall be given to the fact that the turn pad will be subjected to slow-moving traffic making hard turns and consequent higher stresses on the pavement.

(8) Where a runway turn pad is provided with a flexible pavement, the surface shall be capable of withstanding the horizontal shear forces exerted by the main landing gear tyres during turning manoeuvres.

(9) The surface of a runway turn pad shall not have surface irregularities that may cause damage to an aircraft using the turn pad.

(10) The surface of a runway turn pad shall be constructed or resurfaced as the case may be, to provide surface friction characteristics at least equal to that of the adjoining runway.

(11) The runway turn pads shall be provided with shoulders of such width as is necessary to prevent surface erosion by the jet blast of the most demanding aeroplane for which the turn pad is intended, and any possible foreign object damage to the aeroplane engines; and as a minimum, the width of the shoulders shall be required to cover the outer engine of the most demanding aeroplane and thus may be wider than the associated runway shoulders.

(12) The strength of runway turn pad shoulders shall be capable of withstanding the occasional passage of the aeroplane it is designed to serve without inducing structural damage to the aeroplane and to the supporting ground vehicles that may operate on the shoulder.

(13) Wheel base means the distance from the nose gear to the geometric center of the main gear.

## **95. Runway strips**

(1) A runway and any associated stopways shall be included in a strip.

(2) A strip shall extend before the threshold and beyond the end of the runway or stopway for a distance of not less than—

- (a) 60m where the code number is 2, 3 or 4;
- (b) 60m where the code number is 1 and the runway is an instrument one; and
- (c) 30m where the code number is 1 and the runway is a non-instrument one.

(3) A strip including a precision approach and non-precision approach runway shall, wherever practicable, extend laterally to a distance of not less than—

- (a) 140m where the code number is 3 or 4; and

(b) 70m where the code number is 1 or 2

on each side of the center line of the runway and its extended center line throughout the length of the strip.

(4) A strip including a non-instrument runway shall extend on each side of the center line of the runway and its extended center line throughout the length of the strip, to a distance of not less than—

(a) 75m where the code number is 3 or 4;

(b) 40m where the code number is 2; and

(c) 30m where the code number is 1

(5) An object situated on a runway strip that may endanger aircraft shall be regarded as an obstacle and shall, as far as practicable, be removed.

(6) Where drains are located on a runway strip consideration shall be given to the location and design of drains on the runway strip to prevent damage to an aeroplane accidentally running off a runway

(7) Where open-air or covered storm water conveyances are installed in the runway strip, consideration shall be made to ensure that their structure does not extend above the surrounding ground so as not to be considered an obstacle and particular attention shall be given to the design and maintenance of an open-air storm water conveyance in order to prevent wildlife attraction, notably birds; and where necessary, it shall be covered by a net.

(8) A fixed object, other than visual aids required for air navigation or those required for aircraft safety purposes which must be sited on the runway strip, and satisfying the relevant frangibility requirement in Part XI, shall not be permitted on any part of the a runway strip of a precision approach runway delineated by the lower edges of the inner transitional surfaces.

(9) A mobile object shall not be permitted on the part of the runway strip referred to in subregulation (8) during the use of the runway for landing or take-off.

(10) The portion of a strip of an instrument runway within a distance of not less than—

- (a) 75m where the code number is 3 or 4; and
- (b) 40m where the code number is 1 or 2;

from the center line of the runway and its extended center line, shall provide a graded area for aeroplanes that the runway is intended to serve in the event of an aircraft running off the runway.

(11) Where operationally required, the portion of a strip of a non-instrument runway within a distance of not less than—

- (a) 75m where the code number is 3 or 4;
- (b) 40m where the code number is 2; and
- (c) 30m where the code number is 1;

from the center line of the runway and its extended center line, shall provide a graded area for aeroplanes which the runway is intended to serve in the event of an aircraft running off the runway.

(12) The surface of a strip that abuts a runway, shoulder or stopway shall be flush with the surface of the runway, shoulder or stopway.

(13) The portion of a strip not less than 30m before the start of a runway, shall be prepared against blast erosion in order to protect a landing aircraft from the danger of an exposed edge.

(14) Where the areas referred to in subregulation (13) have paved surfaces, they shall be able to withstand the occasional passage of the critical aeroplane for runway pavement design.

## 96. Slopes on runway strips

(1) The longitudinal slope along that portion of a strip to be graded shall not exceed—

- (a) 1.5 percent where the code number is 4;
- (b) 1.75 percent where the code number is 3; and
- (c) 2 percent where the code number is 1 or 2.

(2) Any longitudinal slope changes on the portion of a strip to be graded shall be gradual as practicable and abrupt changes or sudden reversals of slopes shall be avoided.

(3) Transverse slopes on that portion of a strip to be graded shall be adequate to prevent the accumulation of water on the surface but shall not exceed—

- (a) 2.5 percent where the code number is 3 or 4; and
- (b) 3 percent where the code number is 1 or 2;

except that in order to facilitate drainage, the slope for the first 3m outward from the runway shoulder or stopway edge shall be negative as measured in the direction away from the runway and may be as great as 5 percent.

(4) The transverse slopes of any portion of a strip beyond that to be graded shall not exceed an upward slope of 5 percent when measured in the direction away from the runway.

(5) Where deemed necessary an open air storm water conveyance may be allowed in the non graded portion of a runway strip and shall be placed as far as practicable from the runway.

(6) Subject to subregulation (5) the RFF procedure shall take into account the location of open air water conveyances within the non graded portion of the runway.

**97. Strength of runway strips**

(1) That portion of a strip of an instrument runway within a distance of not less than—

- (a) 75m where the code number is 3 or 4; and
- (b) 40m where the code number is 1 or 2;

from the center line of the runway and its extended center line shall be prepared or constructed in order to minimise hazards arising from differences in load-bearing capacity to aeroplanes which the runway is intended to serve in the event of an aircraft running off the runway.

(2) That portion of a strip containing a non-instrument runway within a distance of not less than—

- (a) 75m where the code number is 3 or 4;
- (b) 40m where the code number is 2; and
- (c) 30m where the code number is 1;

from the center line of the runway and its extended center line, shall be prepared or constructed in order to minimise hazards arising from differences in load-bearing capacity to aeroplanes which the runway is intended to serve in the event of an aircraft running off the runway.

**98. Runway end safety area**

(1) A runway end safety area shall be provided at each end of a runway strip where—

- (a) the code number is 3 or 4; and
- (b) the code number is 1 or 2 and the runway is an instrument one.

(2) A runway end safety area shall be provided at each end of a runway strip where the code number is 1 or 2 and the runway is a non- instrument one, as may be prescribed by the authority.

(3) A runway end safety area shall extend from the end of a runway strip to a distance of not less than 90m where the—

- (a) code number is 3 or 4; and
- (b) code number is 1 or 2 and the runway is an instrument one.

(4) Where an arresting system is installed, the above length referred to in subregulation (3) may be reduced, based on the design specification of the system and subject to acceptance by the authority.

(5) In the case of a new aerodrome and where practicable for an existing aerodrome, a runway end safety area shall—

- (a) extend from the end of a runway strip to a distance of not less than—
  - (i) 240m where the code number is 3 or 4 or a reduced length when an arresting system is installed;
  - (ii) 120m where the code number is 1 or 2 and the runway is an instrument one; or a reduced length when an arresting system is installed;
  - (iii) 30m where the code number is 1 or 2 and the runway is a non-instrument one; and
- (b) the width of a runway end safety area shall be equal to that of the graded portion of the associated runway strip.

(6) The width of a runway safety area shall not be less than twice that of the associated runway.

(7) An object situated on a runway end safety area which may endanger aeroplanes shall be regarded as an obstacle and shall as far as practicable be removed.



(8) A runway end safety area shall provide a cleared and graded area for aeroplanes which the runway is intended to serve in the event of an aeroplane undershooting or overrunning the runway.

(9) The slopes of a runway end safety area shall be such that no part of the runway end safety area penetrates the approach or take-off climb surface.

(10) The longitudinal slopes of a runway end safety area shall not exceed a downward slope of 5 percent and all longitudinal slope changes shall be as gradual as practicable with abrupt changes or sudden reversals of slopes avoided.

(11) The transverse slopes of a runway end safety area shall not exceed an upward or downward slope of 5 percent and transitions between differing slopes shall be as gradual as practicable.

(12) A runway end safety area shall be prepared or constructed so as to reduce the risk of damage to an aeroplane undershooting or overrunning the runway, enhance aeroplane deceleration and facilitate the movement of rescue and fire-fighting vehicles as required in regulation 253.

## **99. Clearways**

(1) The origin of a clearway shall where provided, be at the end of the take-off run available.

(2) The length of a clearway shall not exceed half the length of the take-off run available.

(3) A clearway shall extend laterally on each side of the extended center line of the runway to a distance of not less than—

- (a) 75m for instrument runways; and
- (b) half of the width of the runway strip for non-instrument runways.

(4) The ground in a clearway shall not project above a plane having an upward slope of 1.25 percent, the lower limit of this plane being a horizontal line which—

- (a) is perpendicular to the vertical plane containing the runway center line; and
- (b) passes through a point located on the runway center line at the end of the take-off run available.

(5) Abrupt upward changes in slope shall be avoided when the slope on the ground in a clearway is relatively small or when the mean slope is upward and in such cases, that portion of the clearway within a distance of 22.5 m or half the runway width, whichever is greater, on each side of the extended center line, the slopes, slope changes and the transition from runway to clearway shall conform with those of the runway with which the clearway is associated.

(6) An object situated on a clearway which may endanger aeroplanes in the air shall be regarded as an obstacle and shall be removed.

## **100. Stopways**

(1) Where provided, a stopway shall have the same width as the runway with which it is associated.

(2) All slopes and changes in slope on a stopway and the transition from a runway to a stopway, shall comply with the requirements of regulation 90 for the runway with which the stopway is associated except that—

- (a) the limitation in regulation 90(2) of a 0.8 percent slope for the first and last quarter of the length of a runway need not be applied to the stopway; and

- (b) at the junction of the stopway and runway and along the stopway, the maximum rate of slope change may be 0.3 percent per 30m (minimum radius of curvature of 10,000m) for a runway where the code number is 3 or 4.

(3) A stopway shall be prepared or constructed so that it is capable, in the event of an abandoned take-off, of supporting the aeroplane which the stopway is intended to serve without inducing structural damage to the aeroplane.

(4) The surface of a paved stopway shall be constructed or resurfaced, as the case may be, to provide surface friction characteristics at or above those of the associated runway.

### **101. Radio altimeter operating area**

(1) A radio altimeter operating area shall be established in the pre-threshold area of a precision approach runway.

(2) A radio altimeter operating area shall extend before the threshold for a distance of not less than 300m.

(3) A radio altimeter operating area shall extend laterally, on each side of the extended center line of the runway, to a distance of 60m, except that, where special circumstances warrant, the distance may be reduced to no less than 30m where an aeronautical study indicates that such reduction will not affect the safety of operations of an aircraft.

(4) All slope changes on a radio altimeter operating area shall be avoided or kept to a minimum where slope changes cannot be avoided, the slope changes shall be gradual as practicable and abrupt changes or sudden reversals of slopes shall be avoided.

(5) The rate of change between two consecutive slopes referred to in subregulation(4) shall not exceed 2 percent per 30m.

**102. Taxiways**

(1) Taxiways shall be provided to permit the safe and expeditious surface movement of an aircraft.

(2) Sufficient entrance and exit taxiways for a runway shall be provided to expedite the movement of aeroplanes to and from the runway, and provision of rapid exit taxiways will be considered where traffic volumes are high.

(3) The design of a taxiway shall be such that, where the cockpit of the aeroplane for which the taxiway is intended remains over the taxiway center line markings, the clearance distance between the outer main wheel of the aeroplane and the edge of the taxiway shall not be less than that set out in the following tabulation—

OMGWS (Outer Main Gear Wheel Span)				
	Up to but not including 4.5m	4.5m up to but not including 6m	6m up to but not including 9m	9m up to but not including 15m
Clearance	1.50m	2.25m	3m <sup>ab</sup> or 4m <sup>c</sup>	4m
<sup>a</sup> on straight portions <sup>b</sup> on curved portions if the taxiway is intended to be used by aeroplanes with a wheel base of less than 18m <sup>c</sup> on curved portions if the taxiway is intended to be used by aeroplanes with a wheel base equal to or greater than 18m.				

(4) A straight portion of a taxiway shall have a width of not less than that set out in the following tabulation —

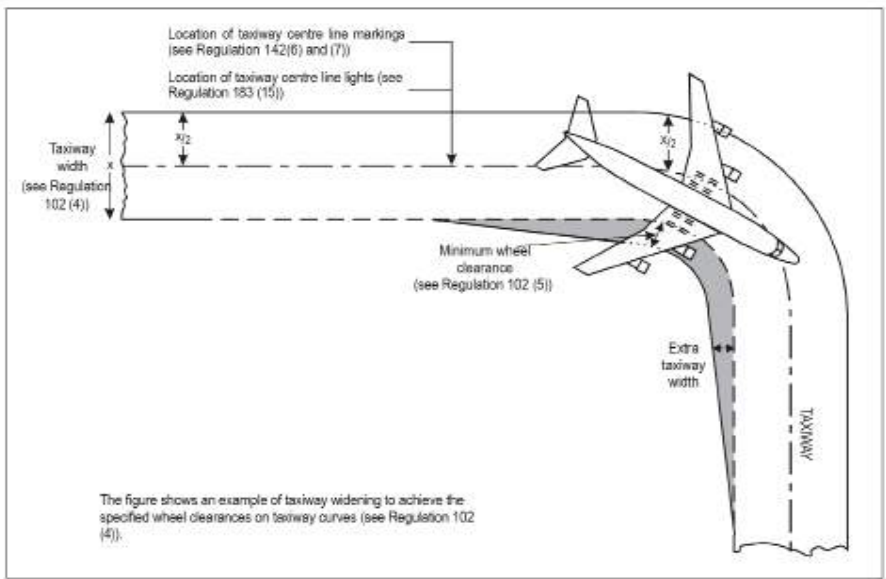
OMGWS (Outer Main Gear Wheel Span)				
	Up to but not including 4.5m	4.5m up to but not including 6m	6m up to but not including 9m	9m up to but not including 15m
Taxiway width	7.5m	10.5m	15m	23m

(5) Changes in the direction of taxiways shall be as few and as small as possible and the radii of the curves shall be compatible with the manoeuvring capability and normal taxiing speeds of the aeroplanes for which the taxiway is intended.

(6) The design of the taxiway curve referred to in subregulation (6) shall be such that, where the cockpit of the aircraft remains over the taxiway center line markings, the clearance distance between the outer main wheels of the aeroplane and the edge of the taxiway shall not be less than those specified in subregulation (3).

(7) An example of widening taxiways to achieve the wheel clearance specified shall be as set out in figure 2.

Figure 2. Taxiway curve



(8) To facilitate the movement of aeroplanes, fillets shall be provided at junctions and intersections of taxiways with runways, aprons and other taxiways.

(9) The design of the fillets shall ensure that the minimum wheel clearances specified in subregulation (3) are maintained when aeroplanes are manoeuvring through the junctions or intersections and consideration shall be given to the aeroplane datum length when designing fillets.

(10) The separation distance between the center line of a taxiway and the center line of a runway, the center line of a parallel taxiway or an object shall not be less than the appropriate dimension specified in Table 2, except that it is permissible to operate with lower separation distances at an existing aerodrome where an aeronautical study indicates that such lower separation distances would not adversely affect the safety or significantly affect the regularity of operations of aeroplanes.

(11) The longitudinal slope of a taxiway shall not exceed—

- (a) 1.5 percent where the code letter is C, D, E or F; and
- (b) 3 percent where the code letter is A or B.

(12) Where slope changes on a taxiway cannot be avoided, the transition from one slope to another slope shall be accomplished by a curved surface with a rate of change not exceeding—

- (a) 1 percent per 30 m (minimum radius of curvature of 3,000m) where the code letter is C, D, E or F; and
- (b) 1 percent per 25m (minimum radius of curvature of 2,500 a) where the code letter is A or B.

Table 2. Taxiway minimum separation distances

Distance between taxiway center line and runway center line (meters)												
Code letter	Instrument runway code number				Non-instrument runways code number				Taxiway center line to taxiway center line (meters)	Taxiway, other than aircraft stand taxilane, center line to object (meters)	Aircraft stand taxilane center line to aircraft stand taxilane center line (meters)	Aircraft stand taxilane center line to object
	1	2	3	4	1	2	3	4				
(1)	(2)	(3)	(4)	(5)	(6)	(7)	(8)	(9)	(10)	(11)	(12)	(13)
A	77.5	77.5	-	-	37.5	47.5	-	-	23	15.5	19.5	12
B	82	82	152	-	42	52	87	-	32	20	28.5	16.5
C	88	88	158	158	48	58	93	93	44	26	40.5	22.5
D	-	-	166	166	-	-	101	101	63	37	59.5	33.5
E	-	-	172.5	172.5	-	-	107.5	107.5	76	43.5	72.5	40
F	-	-	180	180	-	-	115	115	91	51	87.5	47.5

(13) Where a change in slope on a taxiway cannot be avoided, the change shall be such that, from any point—

- (a) 3m above the taxiway, it is possible to see the whole surface of the taxiway for a distance of at least 300 m from that point, where the code letter is C, D, E or F;
- (b) 2m above the taxiway, it is possible to see the whole surface of the taxiway for a distance of at least 200m from that point, where the code letter is B; and
- (c) 1.5m above the taxiway, it is possible to see the whole surface of the taxiway for a distance of at least 150m from that point, where the code letter is A.

(14) The transverse slopes of a taxiway shall be sufficient to prevent the accumulation of water on the surface of the taxiway but shall not exceed—

- (a) 1.5 percent where the code letter is C, D, E or F; and
- (b) 2 percent where the code letter is A or B.

(15) The strength of a taxiway shall be at least equal to that of the runway it serves, due consideration shall be given to the fact that a taxiway will be subjected to a greater density of traffic and, as a result of slow moving and stationary aeroplanes, to higher stresses than the runway it serves.

(16) The surface of a taxiway shall not have irregularities that cause damage to aeroplane structures.

(17) The surface of a paved taxiway shall be so constructed or resurfaced as to provide suitable surface friction characteristics.

### **103. Rapid exit taxiways**

(1) A rapid exit taxiway shall be designed with a radius of turn-off curve of not less than—

- (a) 550m where the code number is 3 or 4; and
- (b) 275m where the code number is 1 or 2;

for purposes of exit speeds under wet conditions of—

- (i) 93 km/h where the code number is 3 or 4; and
- (ii) 65 km/h where the code number is 1 or 2.

(2) The radius of the fillet on the inside of the curve at a rapid exit taxiway shall be sufficient to provide a widened taxiway throat in order to facilitate early recognition of the entrance and turn-off onto the taxiway.

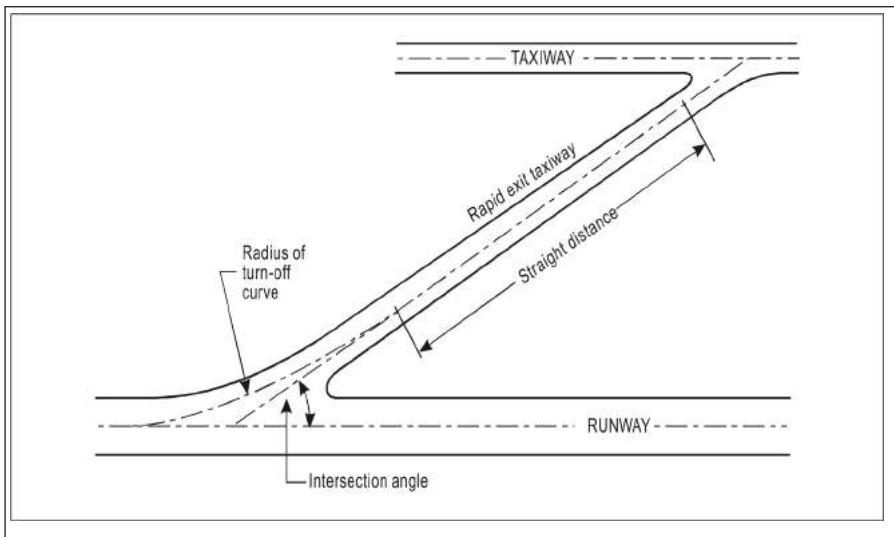


(3) A rapid exit taxiway shall include a straight distance after the turn-off curve sufficient for an exiting aircraft to come to a full stop clear of any intersecting taxiway.

(4) The intersection angle of a rapid exit taxiway with the runway shall preferably be  $30^\circ$  but in any case shall not be not greater than  $45^\circ$  and not less than  $25^\circ$ .

(5) The design of a rapid exit taxiway shall take the form set out in the figure 3.

*Figure 3: Rapid exit taxiway*



#### **104. Taxiways on bridges**

(1) The width of that portion of a taxiway bridge capable of supporting aeroplanes, as measured perpendicularly to the taxiway center line, shall not be less than the width of the graded area of the strip provided for that taxiway, unless a proven method of lateral restraint is provided, which shall not be hazardous for aeroplanes for which the taxiway is intended.

(2) Access shall be provided for rescue and fire-fighting vehicles to intervene in both directions within the specified response time, to the largest aeroplane, for which the taxiway bridge is intended.

(3) A bridge shall be constructed on a straight section of the taxiway with a straight section on both ends of the bridge to facilitate the alignment of aeroplanes approaching the bridge.

### **105. Taxiway shoulders**

(1) Straight portions of a taxiway where the code letter is C, D, E or F shall be provided with shoulders which extend symmetrically on each side of the taxiway so that the overall width of the taxiway and its shoulders on straight portions is not less than—

- (a) 44m where the code letter is F;
- (b) 38m where the code letter is E;
- (c) 34m where the code letter is D; and
- (d) 25m where the code letter is C.

(2) On taxiway curves, junctions or intersections, where increased pavement is provided, the shoulder width shall not be less than that on the adjacent straight portions of the taxiway.

(3) Where a taxiway is intended to be used by turbine-engined aeroplanes, the surface of the taxiway shoulder shall be prepared to resist erosion and the ingestion of the surface material by aeroplane engines.

### **106. Taxiway strips**

(1) A taxiway, other than an aircraft stand taxiway, shall be included in a strip.

(2) A taxiway strip shall extend symmetrically on each side of the center line of the taxiway throughout the length of the taxiway to not less than the distance from the center line set out in Table 2, column 11.

(3) The taxiway strip shall provide an area clear of objects which may endanger taxiing aeroplane taking into consideration the location and design of drains, on a taxiway strip to prevent damage to an aircraft accidentally running off a taxiway.

(4) Where open air or covered storm water conveyances are installed in a taxiway strips, consideration shall be given such that their structure does not extend above the surrounding ground in order not to be considered as an obstacle.

(5) The aerodrome operator shall give particular attention to the design and maintenance of open-air storm water conveyance to prevent wildlife attraction such as birds and where required, the water conveyance shall be covered with a net.

(6) Where considered necessary for proper drainage, an open-air storm water conveyance shall be allowed only in the non-graded portion of a taxiway strip and shall be placed as far as practicable from the taxiway.

(7) The aerodrome rescue and fire-fighting procedure (RFF) shall take into account the location of open air water conveyances within the non-graded portion of a taxiway strip.

(8) The center portion of a taxiway strip shall provide a graded area to a distance from the center line of the taxiway of not less than —

- (a) 10.25m where the Outer Main Gear Wheel Span is up to but not including 4.5m;
- (b) 11m where the Outer Main Gear Wheel Span is 4.5m up to but not including 6m;
- (c) 12.50m where the Outer Main Gear Wheel Span is 6m up to but not including 9m;
- (d) 18.50m where the OMGWS is 9m up to but not including 15m, where the code letter is D;

- (e) 19m where the OMGWS is 9m up to but not including 15m, where the code letter is E; and
- (f) 22m where the OMGWS is 9 m up to but not including 15m, where the code letter is F.

(9) The surface of the strip shall be flushed at the edge of the taxiway or shoulder, if provided, and the graded portion shall not have an upward transverse slope exceeding—

- (a) 2.5 percent for strips where the code letter is C, D, E or F; and
- (b) 3 percent for strips of taxiways where the code letter is A or B;

the upward slope being measured with reference to the transverse slope of the adjacent taxiway surface and not the horizontal and the downward transverse slope shall not exceed 5 percent measured with reference to the horizontal.

(10) The transverse slopes on any portion of a taxiway strip beyond that to be graded shall not exceed an upward or downward slope of 5 percent as measured in the direction away from the taxiway.

**107. Holding bays, runway holding positions, intermediate holding positions and road holding positions**

(1) A holding bay shall be provided at aerodromes where the traffic density is medium or heavy.

- (2) A runway holding position shall be established—
  - (a) on the taxiway, at the intersection of a taxiway and a runway; and
  - (b) at an intersection of a runway with another runway where the former runway is part of a standard taxi-route.

(3) A runway-holding position shall be established on a taxiway where the location or alignment of the taxiway is such that a

taxiing aircraft or vehicle can infringe an obstacle limitation surface or interfere with the operation of radio navigation aids.

(4) An intermediate holding position shall be established on a taxiway at any point other than a runway-holding position where it is desirable to define a specific holding limit.

(5) A road-holding position shall be established at an intersection of a road with a runway.

(6) The distance between a holding bay, a runway-holding position established at a taxiway and a runway intersection or road-holding position and the center line of a runway shall be in accordance with Table 3 and, in the case of a precision approach runway such that a holding aircraft or vehicle will not interfere with the operation of radio navigation aids or penetrate the inner transitional surface.

(7) At elevations greater than 2300ft the distance of 90m specified in Table 3 for a precision approach runway code number 4 shall be increased as follows—

- (a) up to an elevation of 6,600ft; 1m for every 330ft in excess of 2300ft;
- (b) elevation in excess of 6,600 ft and up to 13,320ft; 13m plus 1.5m for every 330ft in excess of 6,600ft; and
- (c) elevation in excess of 13,320ft and up to 16 650ft; 43m plus 2m for every 330ft in excess of 13,320ft.

(8) If a holding bay, runway-holding position or road-holding position for a precision approach runway code number 4 is at a greater elevation compared to the threshold, the distance specified in Table 3 shall be further increased by 5m for every meter the bay or position is higher than the threshold.

(9) The location of a runway-holding position established in accordance with subregulation (3) shall be such that a holding aircraft

or vehicle will not infringe with the obstacle free zone, approach surface, take-off climb surface or ILS critical or sensitive area or interfere with the operation of radio navigation aids.

*Table 3. Minimum distance from the runway center line to a holding bay, runway-holding position or road-holding position*

Type of Runway	Code Number			
	1	2	3	4
Non-instrument	30m	40m	75m	75m
Non-precision approach	40m	40m	75m	75m
Precision approach category I	60m <sup>b</sup>	60m <sup>b</sup>	90m <sup>a,b</sup>	90m <sup>a,b</sup>
Precision approach category II and III	-	-	90m <sup>a,b</sup>	90m <sup>a,b</sup>
Take-off runway	30m	40m	75m	75m
<p><sup>a</sup> If a holding bay, runway-holding position or road-holding position is at a lower elevation compared to the threshold, the distance may be decreased by 5m for every meter the bay or holding position is lower than the threshold, contingent upon not infringing the inner transitional surface.</p> <p><sup>b</sup> This distance may be increased to avoid interference with radio navigation aids, particularly the glide path and localizer facilities.</p>				

## 108. Aprons

(1) Aprons shall be provided where necessary to permit the on- and off-loading of passengers, cargo or mail as well as the servicing of aircrafts without interfering with the aerodrome traffic.

(2) The total apron area shall be adequate to permit expeditious handling of the aerodrome traffic at its maximum anticipated density.

(3) Every part of an apron shall be capable of withstanding the traffic of the aircraft it is intended to serve, due consideration shall be given to the fact that some portions of the apron will be subjected to a higher density of traffic and, as a result of slow moving or stationary aircraft, to higher stresses than a runway.

(4) Slopes on an apron, including those on an aircraft stand taxilane, shall be sufficient to prevent accumulation of water on the surface of the apron but shall be kept as level as drainage requirements permit.

(5) The maximum slope on an aircraft stand shall not exceed 1 percent where applicable.

(6) An aircraft stand shall have the following minimum separation distances between an aircraft entering or exiting the stand and any adjacent building, aircraft on another stand and other objects—

Code letter	Clearance
A	3 m
B	3 m
C	4.5 m
D	7.5 m
E	7.5 m
F	7.5 m

(7) Where special circumstances warrant, the separation distances may be reduced at a nose-in aircraft stand, where the code letter is D, E or F—

- (a) between the terminal, including any fixed passenger bridge, and the nose of an aircraft; and
- (b) over any portion of the stand provided with azimuth guidance by a visual docking guidance system.

(8) Consideration shall be given to the provision of service roads and to maneuvering and storage area for ground equipment on aprons.

## **109. Isolated aircraft parking position**

(1) An isolated aircraft parking position shall be designated or the aerodrome control tower shall be advised of an area or areas suitable for the parking of an aircraft which is known or believed to be the subject of unlawful interference, or which for other reasons needs to be isolated from normal aerodrome activities.

(2) The isolated aircraft parking position shall be located at the maximum distance practicable and in any case not less than 100m from other parking positions, buildings or public areas, among others.

(3) In establishing the isolated aircraft parking position, care shall be taken to ensure that the position is not located over underground utilities such as gas or aviation fuel and, to the extent feasible, electrical or communication cables.

## **PART IX—OBSTACLE RESTRICTION AND REMOVAL**

### **110. Establishment of obstacle limitation surfaces**

(1) An aerodrome operator shall ensure that the obstacle limitation surfaces are established for the aerodrome in accordance with these Regulations.

(2) An aerodrome operator shall monitor the established obstacle limitation surfaces around the aerodrome for infringement by objects, buildings or other structures.

(3) An aerodrome operator shall establish a systematic means of surveying and monitoring any object that penetrates the obstacle limitation surfaces around the aerodrome and report any penetration immediately to the authority.

(4) The survey referred in subregulation (3) shall be in accordance with these Regulations, and shall be submitted to the



authority for approval and to the Aeronautical Information Services for incorporation into the Aeronautical Information Publication.

(5) An aerodrome operator shall through the AIS notify the aerodrome users about any object that penetrates the obstacle limitation surfaces around the aerodrome.

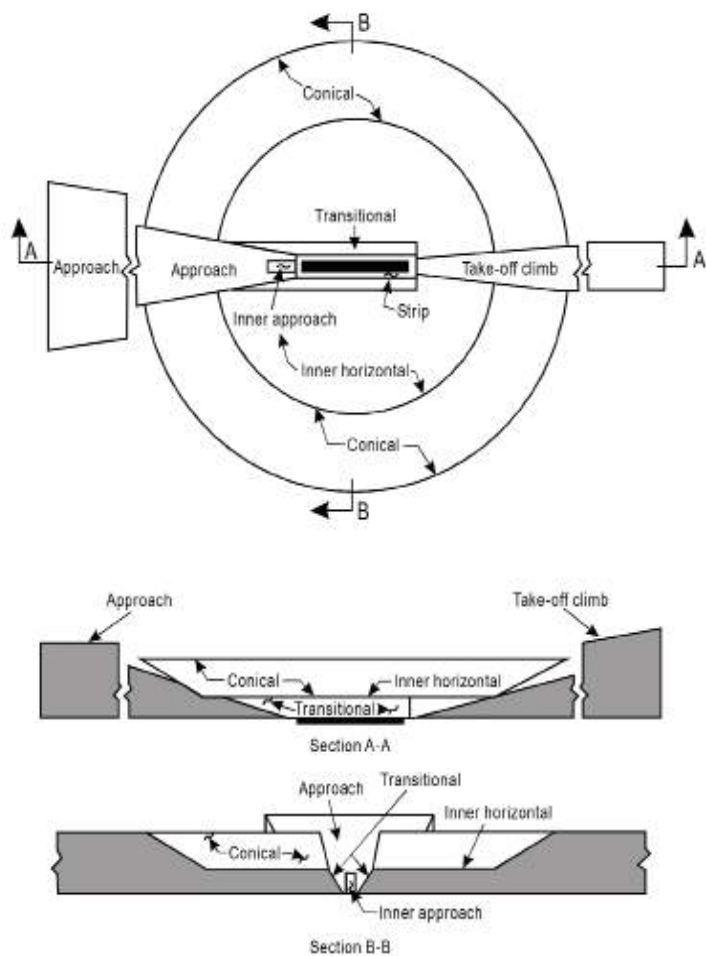
(6) The aerodrome operator shall work jointly with the authority to plan and determine the allowable height limits for new developments in the vicinity of and outside the aerodrome and the type of instrument or visual flight operations that may be permitted taking the obstacle survey plan into account.

### **111. Obstacle limitation surfaces**

The obstacle limitation surfaces shall comprise the surfaces shown in Figures 4 and 5 below—

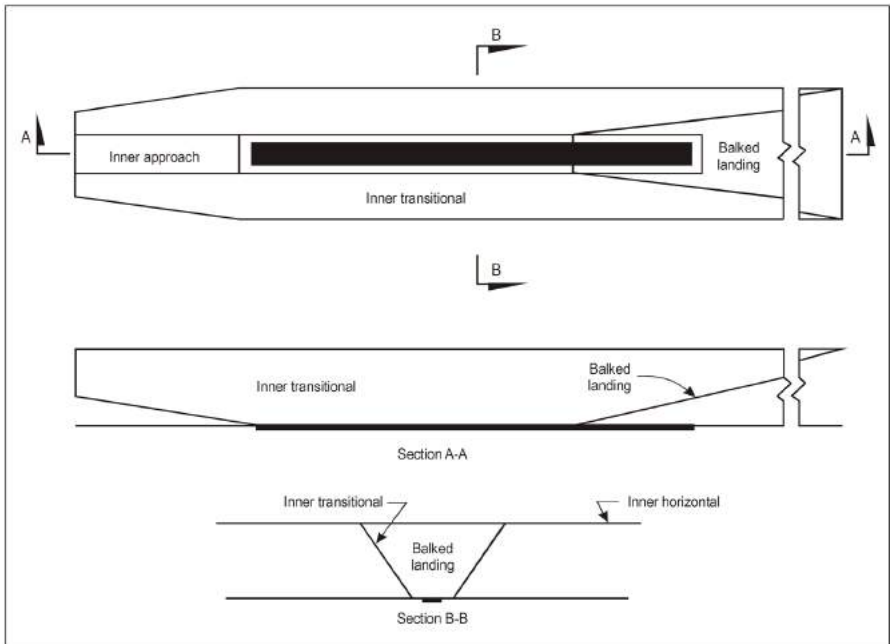
- (a) outer horizontal surface;
- (b) conical surface;
- (c) inner horizontal surface;
- (d) approach surface;
- (e) inner approach surface;
- (f) transitional surface;
- (g) inner transitional surface;
- (h) balked landing surface; and
- (i) take-off climb surface.

Figure 4. Obstacle limitation surfaces



See Figure 5 for inner transitional and balked landing obstacle limitation surfaces and Schedule 8 for a three-dimensional view

*Figure 5 Inner approach, inner transitional and balked landing obstacle limitation surfaces*



## 112. Outer horizontal surface

(1) An outer horizontal surface is a horizontal plane around an aerodrome beyond the limits of the conical surface and represents the level above which consideration needs to be given to the control of new obstacles in order to facilitate practicable and efficient instrument approach procedures and together with the conical and inner horizontal surfaces to ensure safe visual manoeuvring in the vicinity of an aerodrome.

(2) An outer horizontal surface shall be established for every aerodrome where the aerodrome reference code is 3 or 4.

(3) For every aerodrome where the aerodrome reference code is 3 or 4, the outer horizontal surface shall extend from the outer and upper periphery of the conical surface to a minimum radius of 15,000m from the aerodrome reference point.

### **113. Conical surface**

(1) The conical surface is a surface sloping upwards and outwards from the periphery of the inner horizontal surface.

(2) The limits of the conical surface shall comprise—

(a) a lower edge coincident with the periphery of the inner horizontal surface; and

(b) an upper edge located at a specified height, as indicated in table 4, above the inner horizontal surface.

(3) The slope of the conical surface shall be measured in a vertical plane perpendicular to the periphery of the inner horizontal surface.

(4) The slope of the conical surface measured in the vertical plane above the horizontal shall be 5% (1:20).

### **114. Inner horizontal surface**

(1) The inner horizontal surface is a surface located in a horizontal plane above an aerodrome and its environs.

(2) Where the aerodrome reference code is 4, the radius or outer limits of the inner horizontal surface shall be measured from each runway threshold to a radius of 4,000m, the circles for two or more thresholds shall be joined by common tangents parallel to the runway center line or center lines to form a racetrack pattern and the boundary of this pattern shall be the boundary of the inner horizontal surface.

(3) Where the aerodrome reference code is 3, the radius or outer limits of the inner horizontal surface shall be measured from the midpoint of each runway threshold to a radius of 4,000m.

(4) Where the aerodrome reference code is 2, the radius or outer limits of the inner horizontal surface shall be measured from the midpoint of each runway threshold to a radius of 2,500m.

(5) Where the aerodrome reference code is 1, the radius or outer limits of the inner horizontal surface shall be measured from the midpoint of each runway threshold to a radius of 2,000m.

(6) The shape of the inner horizontal surface need not be circular.

(7) The height of the inner horizontal surface shall be 45m above the mid-point of the lowest runway threshold existing or proposed for the aerodrome.

### **115. Approach surface**

(1) The approach surface shall be an inclined plane or combination of planes preceding the threshold.

(2) The limits of the approach surface shall comprise—

(a) an inner edge of specified length, horizontal and perpendicular to the extended center line of the runway and located at a distance of 60m before the threshold, except in the case of non-instrument runways where the code number is 1 and where the distance is 30m;

(b) two sides originating at the ends of the inner edge and diverging uniformly at a specified rate, as indicated in table 4, from the extended center line of the runway; and

(c) an outer edge parallel to the inner edge.

(3) The surfaces referred to in subregulation (2) shall be varied where lateral offset, offset or curved approaches are utilised, specifically, two sides originating at the ends of the inner edge and diverging uniformly at a specified rate from the extended center line of the lateral offset, offset or curved ground track.

(4) The elevation of the inner edge shall be equal to the elevation of the mid-point of the threshold.

(5) The slope of the approach surface shall be measured in the vertical plane containing the center line of the runway and shall continue containing the center line of any lateral offset or curved ground track.

(5) The dimensions and slope of the approach surface are set out in table 4 of these Regulations.

### **116. Inner approach surface**

(1) The inner approach surface shall be a rectangular portion of the approach surface immediately preceding the threshold.

- (2) The limits of the inner approach surface shall comprise—
  - (a) an inner edge coincident with the location of the inner edge of the approach surface but with its own specified length as indicated as set out in table 4;
  - (b) two sides originating at the ends of the inner edge and extending parallel to the vertical plane containing the center line of the runway; and
  - (c) an outer edge parallel to the inner edge.

### **117. Transitional surface**

(1) The transitional surface shall be a complex surface along the side of the strip and part of the side of the approach surface, that slopes upwards and outwards to the inner horizontal surface.

- (2) The limits of the transitional surface shall comprise—
  - (a) a lower edge beginning at the intersection of the side of the approach surface with the inner horizontal surface and extending down the side of the approach surface to the inner edge of the approach surface and from there along the length of the strip parallel to the runway center line; and
  - (b) an upper edge located in the plane in the inner horizontal surface.
- (3) The elevation of a point on the lower edge shall be—
  - (a) along the side of the approach surface equal to the elevation of the approach surface at that point; and

(b) along the strip equal to the elevation of the nearest point on the center line of the runway or its extension.

(4) In accordance with subregulation (3)(b)—

(a) the transitional surface along the strip shall be curved where the runway profile is curved or a plane where the runway profile is a straight line; and

(b) the intersection of the transitional surface with the inner horizontal surface shall be a curved or a straight line depending on the runway profile.

(5) The slope of the transitional surface shall be measured in a vertical plane at right angles to the center line of the runway.

#### **118. Inner transitional surface**

(1) The inner transitional surface shall be the controlling obstacle limitation surface for navigation aids, aircraft and vehicles that must be near the runway and shall not be penetrated except for frangible objects.

(2) The inner transitional surface is a surface similar to the transitional surface but closer to the runway.

(3) The limits of an inner transitional surface shall comprise—

(a) a lower edge beginning at the end of the inner approach surface and extending down the side of the inner approach surface to the inner edge of that surface, from there along the strip parallel to the runway center line to the inner edge of the balked landing surface and from there up the side of the balked landing surface to the point where the side intersects the inner horizontal surface; and

(b) an upper edge located in the plane of the inner horizontal surface.

- (4) The elevation of a point on the lower edge shall be—
  - (a) along the side of the inner approach surface and balked landing surface equal to the elevation of the particular surface at that point; and
  - (b) along the strip equal to the elevation of the nearest point on the center line of the runway or its extension.
- (5) In accordance with subregulation (3) (b)—
  - (a) the inner transitional surface along the strip shall be curved where the runway profile is curved or a plane where the runway profile is a straight line; and
  - (b) the intersection of the inner transitional surface with the inner horizontal surface shall be a curved or a straight line depending on the runway profile.
- (6) The slope of inner transitional surface shall be measured in a vertical plane at right angles to the center line of the runway.

### **119. Balked landing surface**

- (1) The balked landing surface shall be an inclined plane located at a specified distance after the threshold, extending between the inner transitional surfaces.
  - (2) The limits of the balked landing surface shall comprise—
    - (a) an inner edge horizontal and perpendicular to the center line of the runway and located at a specified distance, as set out in table 4, after the threshold;
    - (b) two sides originating at the ends of the inner edge and diverging uniformly at a specified rate, as set out in table 4, from the vertical plane containing the center line of the runway; and
    - (c) an outer edge parallel to the inner edge and located in the plane of the inner horizontal surface.



(3) The elevation of the inner edge for a balked landing surface shall be equal to the elevation of the runway center line at the location of the inner edge.

(4) The slope of the balked landing surface as set out in table 4, shall be measured in the vertical plane containing the center line of the runway.

## **120. Take-off climb surface**

(1) The take-off climb surface is an inclined plane or other specified surface beyond the end of a runway or clearway.

(2) The limits of the take-off climb surface shall comprise—

- (a) an inner edge horizontal and perpendicular to the center line of the runway and located either at a specified distance beyond the end of the runway or at the end of the clearway where such is provided and its length exceeds the specified distance set out in table 5;
- (b) two sides originating at the ends of the inner edge, diverging uniformly at a specified rate from the take-off track to a final width set out in table 5 and continuing thereafter at that width for the remainder of the length of the take-off climb surface; and
- (c) an outer edge horizontal and perpendicular to the specified take-off track.

(3) The elevation of the inner edge for a take-off climb surface shall be equal to the highest point on the runway center line between the end of the runway and the inner edge, except where a clearway is provided, the elevation shall be equal to the highest point on the ground on the center line of the clearway.

(4) In the case of a straight take-off flight path, the slope of the take-off climb surface shall be measured in the vertical plane containing the center line of the runway.

(5) In the case of a take-off flight path involving a turn, the take-off climb surface shall be a complex surface containing the horizontal normal to its center line and, the slope of the center line shall be the same as that for a straight take-off flight path.

(6) The dimensions of the take-off climb surface shall be as set out in table 5.

**121. Obstacle limitation requirements**

(1) The requirements for obstacle limitation surfaces shall be defined in these Regulations on the basis of the intended use of a runway, that is, take-off or landing and the type of approach and shall be applied where such use is made of the runway.

(2) Where aircraft operations are conducted to or from both directions of a runway, the functions of certain surfaces may be nullified due to more stringent requirements of another lower surface.

**122. Obstacle limitation requirements for non-instrument runways**

(1) The following obstacle limitation surfaces shall be established for a non-instrument runway—

- (a) conical surface;
- (b) inner horizontal surface;
- (c) approach surface;
- (d) transitional surfaces; and
- (e) outer horizontal surface, where the aerodrome reference code is 3 or 4.

(2) The heights and slopes of the surfaces shall not be greater than and their other dimensions shall not be less than, those specified in Table 4.

(3) A new object or extension of an existing object shall not be permitted above an approach or transitional surface except where the new object or extension of the new object is likely to be shielded by an existing immovable object.

(4) The circumstances under which the shielding principle may reasonably be applied as set out in Schedule 2 to these Regulations.

(5) A new object or extension of an existing object shall not be permitted above the conical surface or inner horizontal surface, except where the object would be shielded by an existing immovable object, or where after an aeronautical study, it is established that the object would not adversely affect the safety of operations or aeroplanes.

(6) Any existing object above any of the surfaces referred to in subregulation(1) shall, as far as practicable, be removed except where in the opinion of the authority, the object is shielded by an existing immovable object or where after an aeronautical study, it is established that the object would not adversely affect the safety or significantly affect the regularity of operations of aeroplanes.

(7) The inner edge or portions of the inner edge of the approach surface may in certain cases, be below the corresponding elevation of the strip, due to transverse or longitudinal slopes on a strip.

(8) Subject to subregulation (7)—

(a) the strip may not have to be levelled to conform with the inner edge of the approach surface or the terrain or objects which are above the approach surface; and

(b) in addition, terrain or objects which are above the approach surface beyond the end of the strip, but below the level of the strip, may not have to be removed unless it is considered that they may endanger aeroplanes.

(9) In considering a proposed construction, account shall be taken of the possible future development of an instrument runway and consequent requirements for more stringent obstacle limitation surfaces.

**Table 4 – Dimensions and slopes of obstacle limitation surfaces approach runways**

Surface and dimensions <sup>a</sup>	RUNWAY CLASSIFICATION									
	Non-instrument				Non-precision approach			Precision approach category		
	Code number				Code number			I Code number		II or III Code number
(1)	1	2	3	4	1,2	3	4	1,2	3,4	3,4
(2)	(3)	(4)	(5)	(6)	(7)	(8)	(9)	(10)	(11)	
CONICAL										
Slope	5%	5%	5%	5%	5%	5%	5%	5%	5%	5%
Height	35 m	55 m	75 m	100 m	60 m	75 m	100 m	60 m	100 m	100 m
Inner Horizontal										
Height	45 m	45 m	45 m	45 m	45 m	45 m	45 m	45 m	45 m	45 m
Radius	2 000 m	2 500 m	4 000 m	4 000 m	3 500 m	4 000 m	4 000 m	3 500 m	4 000 m	4 000 m
Inner Approach										
Width	—	—	—	—	—	—	—	90 m	120 m <sup>2</sup>	120 m <sup>2</sup>
Distance from threshold	—	—	—	—	—	—	—	60 m	60 m	60 m
Length	—	—	—	—	—	—	—	900 m	900 m	900 m
Slope								2.5%	2%	2%
Approach										
Length of inner edge	60 m	80 m	150 m	150 m	140 m	280 m	280 m	140 m	280 m	280 m
Distance from threshold	30 m	60 m	60 m	60 m	60 m	60 m	60 m	60 m	60 m	60 m
Divergence (each side)	10%	10%	10%	10%	15%	15%	15%	15%	15%	15%
First section										
Length	1 600 m	2 500 m	3 000 m	3 000 m	2 500 m	3 000 m	3 000 m	3 000 m	3 000 m	3 000 m
Slope	5%	4%	3.33%	2.5%	3.33%	2%	2%	2.5%	2%	2%
Second section										
Length	—	—	—	—	—	3 600 m <sup>b</sup>	3 600 m <sup>b</sup>	12 000 m	3 600 m <sup>b</sup>	3 600 m <sup>b</sup>
Slope	—	—	—	—	—	2.5%	2.5%	3%	2.5%	2.5%
Horizontal section										
Length	—	—	—	—	—	8 400 m <sup>b</sup>	8 400 m <sup>b</sup>	—	8 400 m <sup>b</sup>	8 400 m <sup>b</sup>
Total length	—	—	—	—	—	15 000 m	15 000 m	15 000 m	15 000 m	15 000 m
Transitional										
Slope	20%	20%	14.3%	14.3%	20%	14.3%	14.3%	14.3%	14.3%	14.3%
Inner Transitional										
Slope	—	—	—	—	—	—	—	40%	33.3%	33.3%
Balked Landing Surface										
Length of inner edge	—	—	—	—	—	—	—	90 m	120 m <sup>2</sup>	120 m <sup>2</sup>

Distance from threshold	—	—	—	—	—	—	—	c	1 800 m <sup>d</sup>	1 800 m <sup>d</sup>
Divergence (each side)	—	—	—	—	—	—	—	10%	10%	10%
Slope	—	—	—	—	—	—	—	4%	3.33%	3.33%
<p>a. All dimensions are measured horizontally unless specified otherwise.</p> <p>b. Variable length</p> <p>c. Distance to the end of strip.</p> <p>d. Or end of runway whichever is less</p> <p>e. Where the code letter is F, the width is increased to 140 m except for those aerodromes that accommodate a code letter F aeroplane equipped with digital avionics that provide steering commands to maintain an established track during the go-around manoeuvre.</p>										

### 123. Obstacle limitation requirements for non-precision approach runway

(1) The following obstacle limitation surfaces shall be established for a non-precision approach runway—

- (a) conical surface;
- (b) outer horizontal surface where the aerodrome reference code is 3 or 4;
- (c) inner horizontal surface;
- (d) approach surface; and
- (e) transitional surfaces.

(2) The heights and slopes of the surfaces shall not be greater than, and their other dimensions not less than, those set out in Table 4, except in the case of the horizontal section of the approach surface as stated in subregulation (3).

(3) The approach surface shall be horizontal beyond the point at which the 2.5 percent slope intersects—

- (a) a horizontal plane 150m above the threshold elevation; or
- (b) the horizontal plane passing through the top of any object that governs the obstacle clearance altitude or height (OCA/H); whichever is higher.

(4) New objects or extensions of existing objects shall not be permitted above an approach surface within 3,000m of the inner edge or above a transitional surface except where the new object or extension would be shielded by an existing immovable object.

(5) A new object or extensions of an existing object shall not be permitted above the approach surface beyond 3,000m from the inner edge, the conical surface or inner horizontal surface, except where in the opinion of the authority, the object would be shielded by an existing immovable object, or where after an aeronautical study, it is established that the object would not adversely affect the safety of operations of aeroplanes.

(6) An existing object above any of the surfaces referred to in subregulation (1) shall as far as practicable, be removed except where in the opinion of the authority, the object is shielded by an existing immovable object or, where after an aeronautical study, it is established that the object would not adversely affect the safety of operations of aeroplanes.

#### **124. Obstacle limitation requirements for precision approach runways**

(1) The following obstacle limitation surfaces shall be established for a precision approach runway category I—

- (a) conical surface;
- (b) inner horizontal surface;
- (c) approach surface;
- (d) transitional surfaces;
- (e) inner approach surface;
- (f) inner transitional surfaces;
- (g) balked landing surface; and
- (h) outer horizontal surface, where the aerodrome reference code is 3 or 4.

(2) The following obstacle limitation surfaces shall be established for a precision approach runway category II or III—

- (a) conical surface;
- (b) inner horizontal surface;

- (c) approach surface and inner approach surface;
- (d) transitional surfaces;
- (e) inner transitional surfaces;
- (f) balked landing surface; and
- (g) outer horizontal surface, where the aerodrome reference code is 3 or 4.

(3) The heights and slopes of the surfaces shall not be greater, and their other dimensions not less than, those set out in Table 4 of these Regulations, except in the case of the horizontal section of the approach surface, which shall be in accordance with subregulation (4).

(4) The approach surface shall be horizontal beyond the point at which the 2.5 percent slope intersects —

- (a) a horizontal plane 150m above the threshold elevation; or
- (b) the horizontal plane passing through the top of any object that governs the obstacle clearance limit; whichever is the higher.

(5) Fixed objects shall not be permitted above the inner approach surface, the inner transitional surface or the balked landing surface, except for frangible objects which owing to their function must be located on the strip.

(6) Mobile objects shall not be permitted above the inner approach surface, the inner transitional surface or the balked landing surface, during the use of the runway for landing.

(7) A new object or extension of an existing object shall not be permitted above an approach surface or a transitional surface except where, in the opinion of the authority, the new object or extension will be shielded by an existing immovable object.

(8) A new object or extensions of an existing object shall not be permitted above the conical surface and the inner horizontal surface

except where in the opinion of the authority, the object will be shielded by an existing immovable object, or where after an aeronautical study, it is determined that the object will not adversely affect the safety of operations of the aeroplanes.

(9) Any existing object above an approach surface, a transitional surface, the conical surface and inner horizontal surface shall as far as practicable be removed except where in the opinion of the authority, the object is shielded by an existing immovable object, or where after aeronautical study it is established that the object will not adversely affect the safety operations of the aeroplanes.

### **125. Obstacle limitation requirements for runways meant for take-off**

(1) Take-off climb surface shall be established for a runway meant for take-off.

(2) The dimension of the take-off climb surface shall be not less than the dimensions specified in Table 5 of these Regulations, except that a lesser length may be adopted for the take-off climb surface where such lesser length will be consistent with procedural measures adopted to govern the outward flight of aeroplanes.

(3) The operational characteristics of aeroplanes for which the runway is intended shall be examined to see if it is desirable to reduce the slope specified in Table 5 where critical operating conditions are to be catered for and if the specified slope is reduced, corresponding adjustment in the length of take-off climb surface shall be made so as to provide protection to a height of 300m.

(4) New objects or extensions of existing objects shall not be permitted above a take-off climb surface except when, in the opinion of the authority, the new object or extension will be shielded by an existing immovable object.

(5) Where no object reaches the 2 percent (1:50) take-off climb surface, new objects shall be limited to preserve the existing obstacle free surface or a surface down to a slope of 1.6 percent (1:62.5).



(6) Existing objects that extend above a take-off climb surface shall as far as practicable be removed except when, in the opinion of the authority, an object is shielded by an existing immovable object, or after aeronautical study it is determined that the object will not adversely affect the safety of operations of aeroplanes.

**Table 5 Dimensions and slopes of obstacle limitation surfaces**

**RUNWAYS MEANT FOR TAKE-OFF**

Surface and dimensions <sup>a</sup>	Code number		
	1	2	3 or 4
(1)	(2)	(3)	(4)
<b>TAKE-OFF CLIMB</b>			
Length of inner edge	60 m	80 m	180 m
Distance from runway end <sup>b</sup>	30 m	60 m	60 m
Divergence (each side)	10 %	10%	12.5%
Final width	380 m	580 m	1,200 m 1,800 m <sup>c</sup>
Length	1,600 m	2,500 m	15,000 m
Slope	5%	4%	2% <sup>d</sup>
<sup>a</sup> All dimensions are measured horizontally unless specified otherwise. <sup>b</sup> The take-off climb surface starts at the end of the clearway if the clearway length exceeds the specified distance. <sup>c</sup> 1800m when intended track includes changes of heading greater than 15° for operations conducted in IMC, VMC by night. <sup>d</sup> Refer to subregulations 125 (3) and 125 (5).			

(7) In certain cases, portions of the inner edge of the take-off climb surface may be below the corresponding elevation of the strip or clearway due to transverse slopes on a strip or clearway.

(8) Subject to subregulation (7) the strip, or clearway may not have to be graded to conform with the inner edge of the take-off climb

surface, and in addition, terrain or objects which are above the take-off climb surface beyond the end of the strip or clearway, but below the level of the strip or clearway, may not have to be removed unless it is considered that they may endanger aeroplanes.

## **126. Objects outside obstacle limitation surfaces and other objects**

(1) In the case of proposed construction beyond the limits of the obstacle limitation surfaces that extend above a height of 150m established, the authority shall be consulted in order to permit an aeronautical study of the effect of such construction on the operations of an aeroplane.

(2) In areas beyond the limits of the obstacle limitation surfaces, all the objects that extend to a height of 150m or more above the ground elevation shall be regarded as obstacles, unless a special aeronautical study indicates that they do not constitute a hazard to the operations of aeroplanes.

(3) All objects which do not project through the approach surface but which would nevertheless adversely affect the optimum siting or performance of visual or non-visual aids shall, as far as practicable, be removed.

(4) Anything which may, in the opinion of the aerodrome operator or the authority, after an aeronautical study, endanger aeroplanes on the movement area or in the air within the limits of the inner horizontal and conical surfaces, shall be regarded as an obstacle and shall be removed in so far as practicable.

(5) Objects in the vicinity of an aerodrome that do not project above any of the surfaces referred to in these Regulations but may constitute a hazard to aeroplanes shall be regarded as an obstacle and shall be removed as far as practicable.

## **127. Authorisation to construct within vicinity of aerodrome**

(1) A person shall not construct a building or a structure within the vicinity of an aerodrome unless authorised by the authority.

(2) Where the authority is consulted regarding a proposed construction, the authority may require the owner of the proposed construction to cause an aeronautical study of the effect of the construction to be carried out, on the operations of aeroplanes.

(3) A person who contravenes this regulation shall be liable to a fine not exceeding seven hundred and fifty thousand currency points.

## **128. Erection of obstacle**

(1) A person shall not cause or permit the erection or growth of an obstacle at an aerodrome or in the vicinity of an aerodrome, where the obstacle may prevent an aeroplane operation from being conducted safely or the aerodrome from being usable.

(2) A person shall not cause or permit any object, to penetrate the obstacle limitation surface, without the written permission of authority where the object may cause an increase in the obstacle clearance altitude, in the height for an instrument approach procedure or of any associated visual circling procedure.

(3) The authority shall in consultation with aerodrome operator of the affected aerodrome review any request for development in the vicinity of an aerodrome; where the object may cause an increase in an obstacle clearance altitude or in the height for an instrument approach procedure or of any associated visual circling procedure.

(4) The object referred to in subregulation (2) includes a new object or an extension above the obstacle limitation surface of an existing object.

(5) The obstacle clearance altitude and height applicable to the obstacle limitation surface and the obstacle limitation requirements shall conform to these Regulations.

(6) An aerodrome operator shall monitor the aerodrome for the growth of any obstacle and shall in consultation with the authority see to it that the obstacle is removed.

(7) A person who contravenes this regulation shall be liable to a fine not exceeding seven hundred and fifty thousand currency points.

### **129. Removal of obstacle**

(1) A person shall remove any obstacle in the vicinity of the aerodrome, except where, after an aeronautical study, the authority determines that the obstacle does not adversely affect the safety or significantly affect the regularity of operations of aeroplanes.

(2) The authority may direct the removal of any obstacle which, in the opinion of the authority, constitutes a hazard to aircraft operations of aeroplanes.

(3) Where an owner fails to remove an obstacle within the time directed by the authority, the authority shall arrange to have the obstacle removed at the cost of the owner of that obstacle.

## **PART X—VISUAL AIDS FOR NAVIGATION**

### **130. Wind direction indicators**

(1) An aerodrome operator shall provide and maintain not less than one wind direction indicator at an aerodrome.

(2) The wind direction indicator referred to in subregulation (1) shall be located so as to be visible from an aircraft in-flight or on the movement area and shall be free from the effects of air disturbances caused by nearby objects.

(3) The wind direction indicator shall be in the form of a truncated cone made of fabric and shall have a length of not less than 3.6m and a diameter, at the larger end of not less than 0.9m.

(4) The wind direction indicator shall be constructed so that it gives a clear indication of the direction of the surface wind and a general indication of the wind speed.

(5) The colour of the wind direction indicator selected shall be one that makes the wind direction indicator clearly visible and understandable from a height of at least 300m, having regard to background.

(6) A combination of two colours shall be used to give adequate conspicuity against changing backgrounds, the colours shall preferably be orange and white, red and white, or black and white, and shall be arranged in five alternate bands, the first and last bands being the darker colour.

(7) The location of not less than one of the wind direction indicators shall be marked by a circular band 15m in diameter and 1.2m wide.

(8) The band shall be centered about the wind direction indicator support and shall be in a colour chosen to give adequate conspicuity, preferably white.

(9) Provision shall be made for illumination of not less than one wind direction indicator at an aerodrome intended for use at night.

### **131. Landing direction indicator**

(1) A landing direction indicator shall be located in a conspicuous place on the aerodrome, where provided.

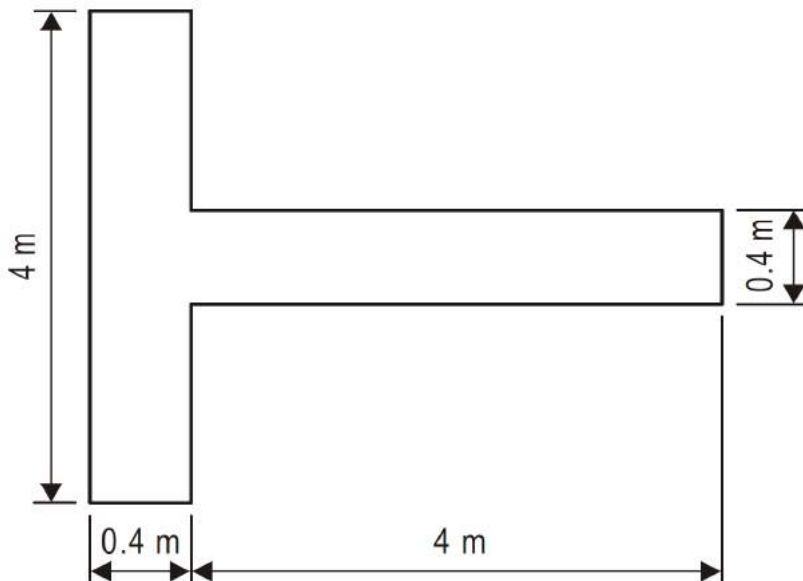
(2) The landing direction indicator shall be in the form of a “T”.

(3) The shape and minimum dimensions of a landing “T” shall be as set out in Figure 6.

(4) The colour of the landing “T” shall be either white or orange, the choice being dependent on the colour that contrasts best with the background against which the indicator will be viewed.

(5) The landing “T” shall either be illuminated or outlined by white lights, where required for use at night.

**Figure 6. Landing direction Indicator**



### **132. Signalling lamp**

(1) An aerodrome operator shall see to it that a signalling lamp is provided in the aerodrome control tower of a controlled aerodrome.

(2) The signalling lamp shall be capable of producing red, green and white signals and of—

- (a) being aimed manually at any target as required;
- (b) giving a signal in any one colour followed by a signal in either of the other two colours; and
- (c) transmitting a message in any one of the three colours by Morse Code up to a speed of not less than four words per minute.

(3) When selecting the green light, the operator shall monitor the restricted boundary of green as specified in Schedule 3.

(4) The beam spread shall not be less than 1° nor greater than 3°, with negligible light beyond 3°.

(5) Where the signalling lamp is intended for use in the daytime, the intensity of the coloured light should not be less than 6000cd.

### **133. Signal panel and signal area**

(1) The authority may where necessary, require a signal panel and a signal area to be provided for the safe operation of aircraft at an aerodrome.

(2) The signal area shall be located so as to be visible for all angles of azimuth above an angle of 10° above the horizontal when viewed from a height of 300m.

(3) The signal area shall be an even horizontal surface of not less than 9m square.

(4) The colour of the signal area shall be chosen to contrast with the colours of the signal panels used and shall be surrounded by a white border of not less than 0.3m wide.

### **134. Markings**

(1) An aerodrome operator shall provide markings for the paved runway center line, paved runway edge, paved runway threshold, paved runway touchdown zone, paved runway holding position, aiming point, paved runway side stripe, paved runway turn pad, taxiways, aprons and the intermediate holding positions at an aerodrome, in accordance with these Regulations.

(2) The runway markings shall be white in colour.

(3) All taxiway markings, runway turn pad markings and aircraft stand markings shall be yellow in colour.

(4) All the apron safety-lines shall be of a conspicuous colour that shall contrast with that used for aircraft stand markings.

(5) The pavement markings at aerodromes where operations take place at night, shall be made with reflective materials designed to enhance the visibility of the markings.

(6) An unpaved taxiway shall be provided, as far as practicable, with the markings prescribed for paved taxiways.

### **135. Interruption of runway markings**

(1) At an intersection of two or more runways, the markings of the more important runway, shall be displayed and the markings of the other runways shall be interrupted.

(2) The runway side stripe markings of the more important runway referred to in subregulation (1) may be either continued across the intersection or interrupted.

(3) The order of importance of runways for the display of runway markings shall be as follows—

- (a) 1<sup>st</sup> — a precision approach runway;
- (b) 2<sup>nd</sup> — a non-precision approach runway; and
- (c) 3<sup>rd</sup> — a non-instrument runway.

(4) At an intersection of a runway and taxiway the markings of the runway shall be displayed and the markings of the taxiway interrupted, except that runway side stripe markings may be interrupted.

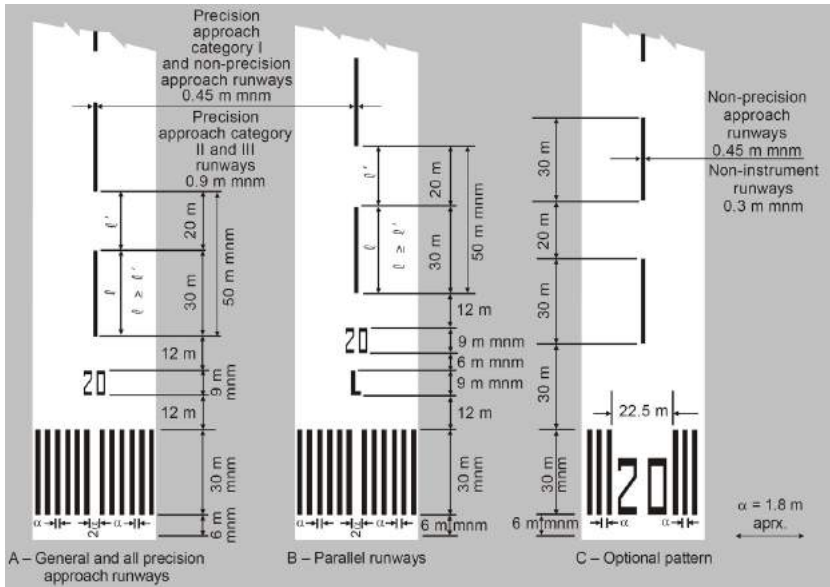
### **136. Runway designation marking**

(1) A runway designation marking shall be provided at the thresholds of a paved runway and shall be as far as practicable, at the thresholds of an unpaved runway.

(2) A runway designation marking shall be located at a threshold set out in Figure 7 as appropriate.



**Figure 7 Runway designation, center line and threshold markings**



(3) Where the runway threshold is displaced from the extremity of the runway, a sign showing the designation of the runway shall be provided for aeroplanes taking off.

(4) A runway designation marking shall consist of a two-digit number and on parallel runways, shall be supplemented with a letter .

(5) Subject to subregulation (4) a single runway, dual parallel runways and triple parallel runways the two-digit number shall be the whole number nearest the one-tenth of the magnetic North when viewed from the direction of approach.

(6) Where there are four or more parallel runways, one set of adjacent runways shall be numbered to the nearest one-tenth magnetic azimuth and the other set of adjacent runways numbered to the next nearest one-tenth of the magnetic azimuth.

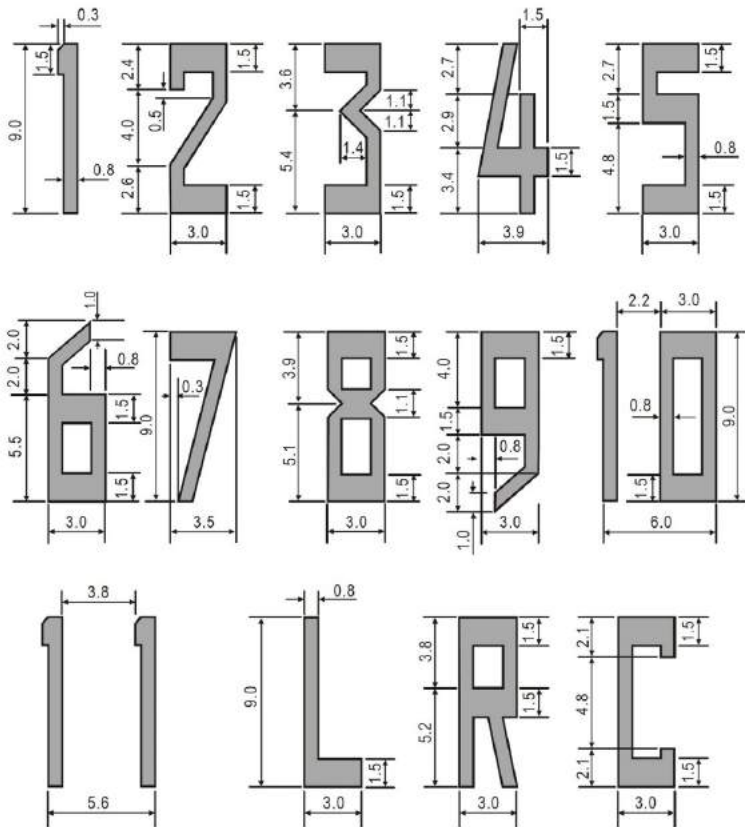
(7) Where the rule in subregulation (5) will give a single digit number preceded by a zero.

(8) In the case of parallel runways, each runway designation number shall be supplemented by a letter as follows, in the order shown from left to right when viewed from the direction of approach—

- (a) for two parallel runways: “L” “R”;
- (b) for three parallel runways: “L” “C” “R”;
- (c) for four parallel runways: “L” “R” “L” “R”;
- (d) for five parallel runways: “L” “C” “R” “L” “R” or “L” “R” “L” “C” “R”; and
- (e) for six parallel runways: “L” “C” “R” “L” “C” “R”.

(9) The numbers and letters referred to in subregulation (4) shall be in the form and proportion set out in Figure 8 and the dimensions shall not be less than those set out in Figure 8, but where the numbers are incorporated in the threshold marking, larger dimensions shall be used in order to fill adequately the gap between the stripes of the threshold marking.

**Figure 8 Form and proportions of numbers and letters for runway designation markings**



*Note.— All units are expressed in metres.*

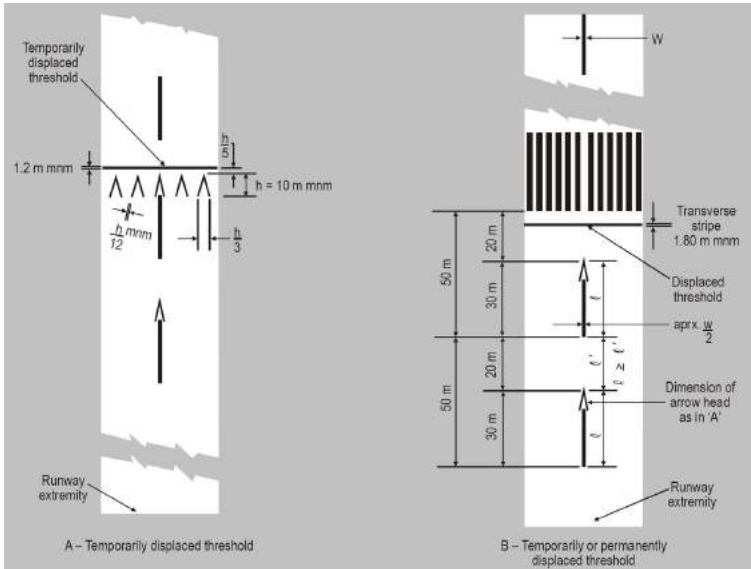
### 137. Runway center line marking

(1) A runway center line marking shall be provided on a paved runway and shall be located along the center line of the runway between the runway designation markings shown in Figure 7, except where interrupted in accordance with regulation 135.

(2) A runway center line marking shall consist of a line of uniformly spaced stripes and gaps and the length of—

- (a) a stripe and the gap shall be not less than 50m or more than 75m; and
  - (b) each stripe shall be equal to the length of the gap or 30m, whichever is greater.
- (3) The width of the stripes shall not be less than—
- (a) 0.90m on precision approach Category II and III runways;
  - (b) 0.45m on non-precision approach runways where the code number is 3 or 4, and precision approach category I runways; and
  - (c) 0.30m on non-precision approach runways where the code number is 1 or 2, and on non-instrument runways.

**Figure 9: Displaced threshold markings**



### 138. Threshold marking

(1) A threshold marking shall be provided at the threshold of a paved instrument runway, and of a paved non-instrument runway where the code number is 3 or 4.

(2) A threshold marking shall be provided, so far as practicable, at the thresholds of an unpaved runway.

(3) The stripes of the threshold marking shall commence 6m from the threshold.

(4) A runway threshold marking shall consist of a pattern of longitudinal stripes of uniform dimensions disposed symmetrically about the center line of a runway as set out in Figure 7 (A) and (B) for a runway width of 45m.

(5) The number of stripes shall be in accordance with the runway width and shall be as follows—

<b>Runway width</b>	<b>Number of stripes</b>
18 m	4
23 m	6
30 m	8
45 m	12
60 m	16;

except that on non-precision approach and non-instrument runways 45m or greater in width, the stripes may be as set out in Figure 7 (C).

(6) The stripes shall extend laterally to within 3m of the edge of a runway or to a distance of 27m on either side of a runway center line, whichever results in the smaller lateral distance.

(7) Where a runway designation marking is placed within a threshold marking there shall be a minimum of three stripes on each side of the center line of the runway.

(8) Where a runway designation marking is placed above a threshold marking, the stripes shall be continued across the runway.

(9) The stripes shall not be less than 30m long and approximately 1.80m wide with spacing of approximately 1.80m between them except that, where the stripes are continued across a runway, a double spacing shall be used to separate the two stripes nearest the center line of the runway, and in the case where the designation marking is included within the threshold marking, this spacing shall be 22.5m.

(10) Where a threshold is displaced from the extremity of the runway or where the extremity of the runway is not square with the runway center line, a transverse strip as set out in Figure 9 (B) shall be added to the threshold marking.

(11) A transverse stripe shall not be less than 1.80m wide.

(12) Where a runway threshold is permanently displaced, arrows conforming to Figure 9 (B) shall be provided on the portion of the runway before the displaced threshold.

(13) Where a runway threshold is temporarily displaced from the normal position, it shall be marked as shown in Figure 9 (A) or 9(B) and all markings prior to the displaced threshold shall be obscured except the runway center line marking, which shall be converted to arrows.

### **139. Aiming point marking**

(1) An aiming point marking shall be provided at each approach end of a paved instrument runway where the code number is 1, 2, 3 or 4.

(2) An aiming point marking shall be provided at each approach end of a paved non-instrument runway where the code number is 3 or 4, when additional conspicuity of the aiming point is desirable.

(3) The aiming point marking shall commence no closer to the threshold than the distance indicated in the appropriate column of table 6 except that, on a runway equipped with a visual approach slope indicator system, the beginning of the marking shall be coincident with the visual approach slope origin.

(4) An aiming point marking shall consist of two conspicuous stripes.

(5) The dimensions of the stripes and the lateral spacing between their inner sides shall be in accordance with the provisions of the appropriate column of table 6.

(6) Where a touchdown zone marking is provided, the lateral spacing between the markings shall be the same as that of the touchdown zone marking.

**Table 6. Location and dimensions of aiming point marking**

Landing distance available				
Location and dimensions  (1)	Less than 800 m  (2)	800 m up to but not including 1200 m  (3)	1 200 m up to but not including 2400 m  (4)	2 400 m and above  (5)
Distance from threshold to beginning of marking	150 m	250 m	300 m	400 m
Length of stripe <sup>a</sup>	30–45 m	30–45 m	45–60 m	45–60 m
Width of stripe	4 m	6 m	6–10 m <sup>b</sup>	6–10 m <sup>b</sup>
Lateral spacing between inner sides of stripes	6 m <sup>c</sup>	9 m <sup>c</sup>	18–22.5 m	18–22.5 m

<sup>a</sup> The greater dimensions of the specified ranges are intended to be used where increased conspicuity is required.

<sup>b</sup> The lateral spacing may be varied within these limits to minimize the contamination of the marking by rubber deposits.

<sup>c</sup> These figures were deduced by reference to the outer main gear wheelspan which is element 2 of the aerodrome reference code, in Tables 1A and 1B.

#### **140. Touchdown zone marking**

(1) A touchdown zone marking shall be provided in the touchdown zone of a paved precision approach runway where the code number is 2, 3 or 4.

(2) A touchdown zone marking shall be provided in the touchdown zone of a paved non-precision approach or non-instrument runway where the code number is 3 or 4 and additional conspicuity of the touchdown zone is desirable.

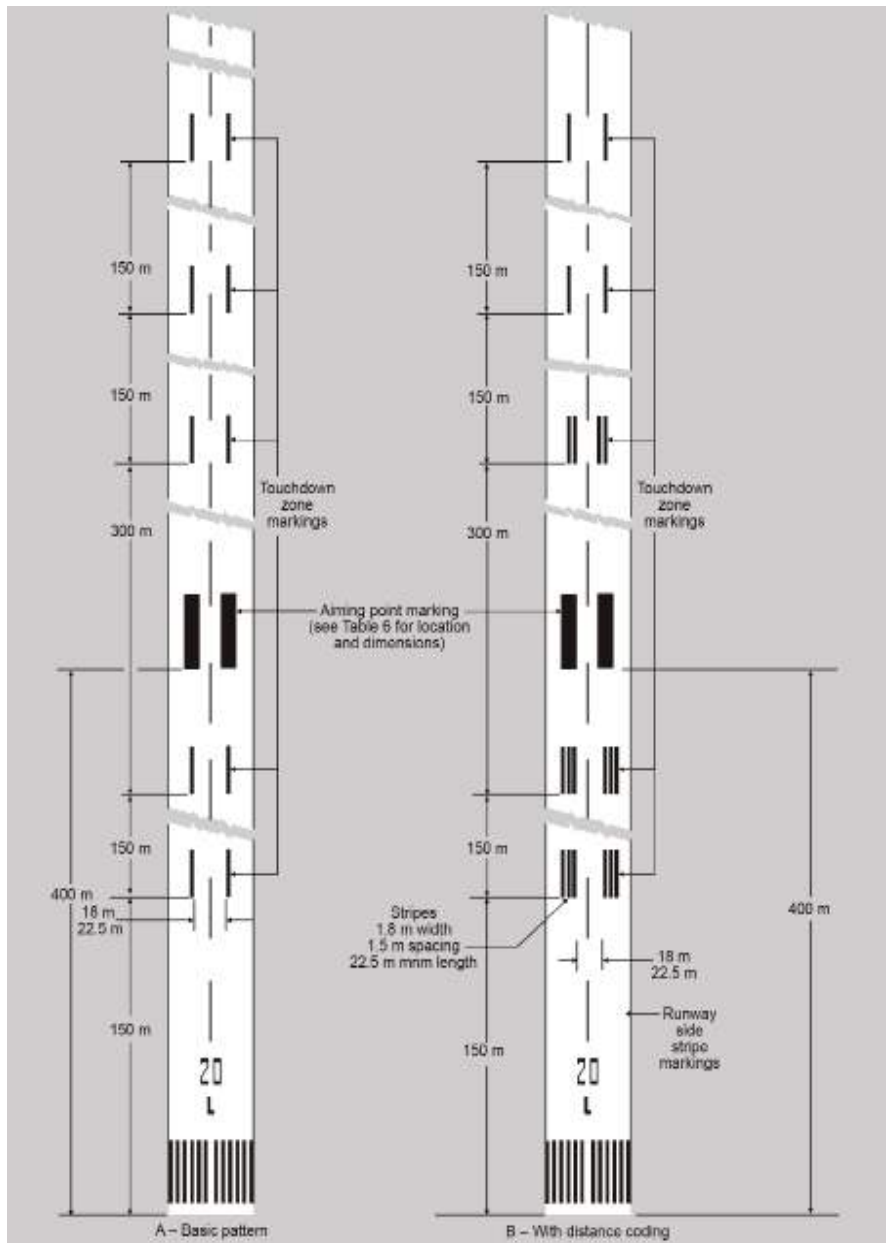
(3) A touchdown zone marking shall consist of pairs of rectangular markings symmetrically disposed about the runway center line with the number of such pairs related to the landing distance available.

(4) Where the marking is to be displayed at both the approach directions of a runway, the distance between the thresholds, shall be as follows—

<b>Landing distance available or the distance between thresholds</b>	<b>Pair of markings</b>
Less than 900 m	1
900m up to but not including 1 200 m	2
1,200m up to but not including 1 500 m	3
1,500m up to but not including 2 400 m	4
2,400m or more	6



**Figure 10 Aiming point and touchdown zone markings  
(Illustrated for a runway with a length of 2,400m or more)**



(5) On a non-precision approach runway where the code number is 2, an additional pair of touchdown zone marking stripes shall be provided 150m beyond the beginning of the aiming point marking.

(6) A touch down zone marking shall conform to either of the two patterns shown in Figure 10.

(7) For the pattern shown in Figure 10 (A), the markings shall not be less than 22.5m long and 3m wide.

(8) For the pattern shown in Figure 10 (B) each stripe of each marking shall not be less than 22.5m long and 1.8m wide with a spacing of 1.5m between adjacent stripes.

(9) The lateral spacing between inner sides of the rectangles shall be equal to that of the aiming point marking where provided.

(10) Where an aiming point marking is not provided, the lateral spacing between the inner sides of the rectangles shall correspond to the lateral spacing specified for the aiming point marking in Table 6 columns 2, 3, 4 or 5 as appropriate.

(11) The pairs of the markings shall be provided at longitudinal spacings of 150m beginning from the threshold, except that pairs of touchdown zone markings coincident with or located within 50m of an aiming point marking shall be deleted from the pattern.

#### **141. Runway side stripe marking**

(1) A runway side stripe marking shall be provided between the thresholds of a paved runway where there is a lack of contrast between the runway edges and the shoulders or the surrounding terrain.

(2) A runway side stripe marking shall be provided on a precision approach runway irrespective of the contrast between the runway edges and the shoulders or the surrounding terrain.

(3) A runway side stripe marking shall consist of two stripes, one placed along each edge of the runway with the outer edge of each stripe approximately on the edge of the runway, except that, where the runway is greater than 60m in width, the stripes shall be located 30 m from the runway center line.

(4) Where a runway turn pad is provided, the runway side stripe marking shall be continued between the runway and the runway turn pad.

(5) A runway side stripe shall have an overall width of not less than 0.9m on runways, 30m or more in width and not less than 0.45m on narrower runways.

#### **142. Taxiway center line marking**

(1) Taxiway center line marking shall be provided on a paved taxiway and apron where the code number is 3 or 4 in such a way as to provide continuous guidance between the runway center line and aircraft stands.

(2) Taxiway center line marking may be provided on a paved taxiway and apron where the code number is 1 or 2 in such a way as to provide continuous guidance between the runway center line and aircraft stands.

(3) Taxiway center line marking shall be provided on a paved runway where the runway is part of a standard taxi-route and—

- (a) there is no runway center line marking; or
- (b) where the taxiway center line is not coincident with the runway center line.

(4) Where it is necessary to denote the proximity of a runway holding position, enhanced taxiway center line marking shall be provided.

(5) Where provided, enhanced taxiway center line marking shall be installed at each taxiway and runway intersection.

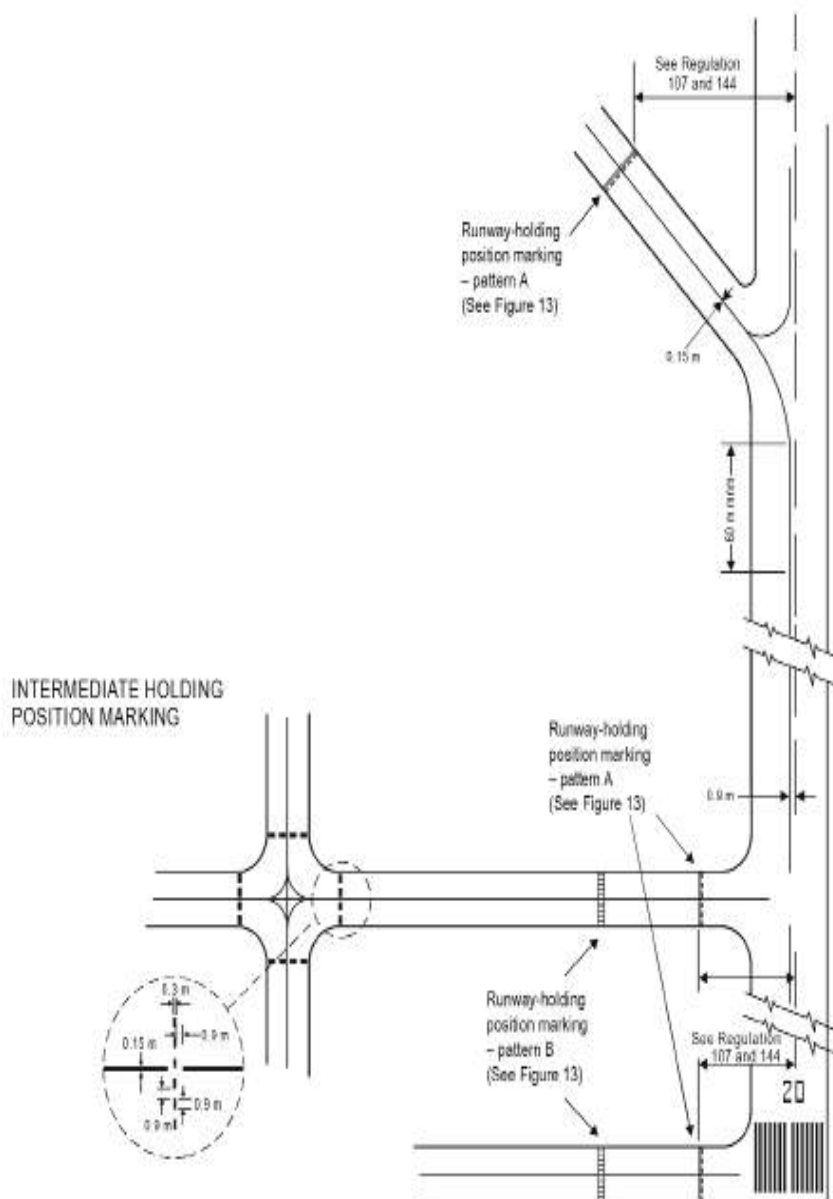
(6) On a straight section of a taxiway, the taxiway center line marking shall be located along the taxiway center line.

(7) On a taxiway curve the marking shall continue from the straight portion of the taxiway at a constant distance from the outside edge of the curve.

(8) At an intersection of a taxiway with a runway where the taxiway serves as an exit from the runway, the taxiway center line marking shall be curved into the runway center line marking as shown in Figures 11 and 29.

(9) The taxiway center line marking shall be extended parallel to the runway center line marking for a distance of at least 60m beyond the point of tangency where the code number is 3 or 4, and for a distance of at least 30m where the code number is 1 or 2.

Figure 11. Taxiway marking



(10) Where a taxiway center line marking is provided on a runway in accordance with subregulation (3) the marking shall be located on the center line of the designated taxiway.

(11) Where provided—

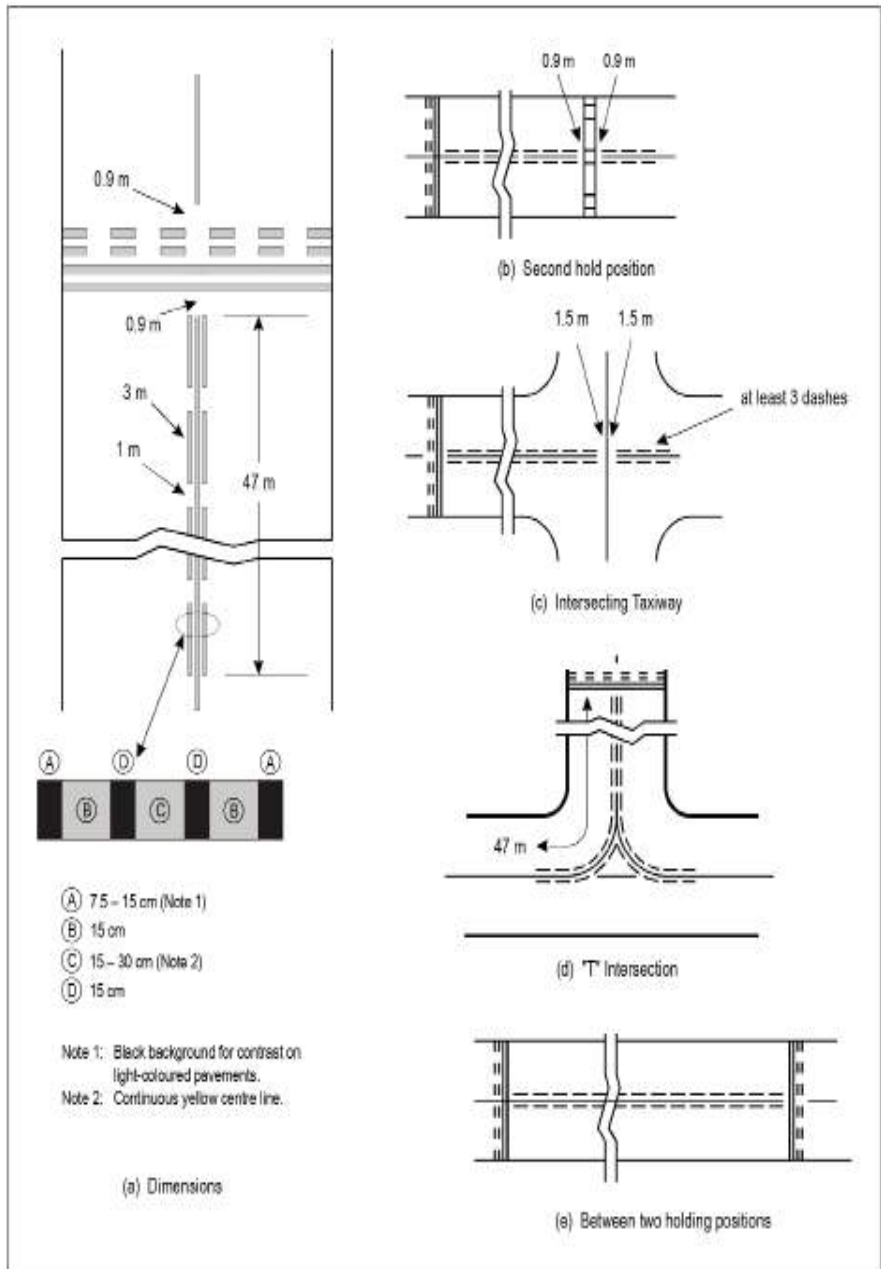
- (a) an enhanced taxiway center line marking shall extend from the runway-holding position pattern A, as set out in Figure 11, to a distance of up to 47m in the direction of travel away from the runway as set out in Figure 12 (a);
- (b) if the enhanced taxiway center line marking intersects another runway-holding position marking, such as for a precision approach category II or III runway that is located within 47m of the first runway-holding position marking, the enhanced taxiway center line marking shall be interrupted 0.9m prior to and after the intersected runway-holding position marking, the enhanced taxiway center line marking shall continue beyond the intersected runway-holding position marking for at least three dashed line segments or 47m from start to finish, whichever is greater as set out in Figure 12(b);
- (c) If the enhanced taxiway center line marking continues through a taxiway or taxiway intersection that is located within 47m of the runway-holding position marking, the enhanced taxiway center line marking shall be interrupted 1.5m prior to and after the point where the intersected taxiway center line crosses the enhanced taxiway center line the enhanced taxiway center line marking shall continue beyond the taxiway or taxiway intersection for at least three dashed line segments or 47m from start to finish, whichever is greater as set out in Figure 12(c);
- (d) two taxiway center lines converge at or before the runway-holding position marking, the inner dashed line shall not be less than 3m in length as set out in Figure 12 (d); and

- (e) there are two opposing runway-holding position markings and the distance between the markings is less than 94m, the enhanced taxiway center line marking shall extend over this entire distance and the enhanced taxiway center line markings shall not extend beyond either runway-holding position marking as set out in Figure 12 (e).

(12) A taxiway center line marking shall not be less than 15cm in width and continuous in length except where it intersects with a runway-holding position marking or an intermediate holding position marking as set out in Figure 11.

(13) Enhanced taxiway center line markings shall be as set out in Figure 12.

**Figure 12- Enhanced taxiway center line marking**





### **143. Runway turn pad marking**

(1) Where a runway turn pad is provided, a runway turn pad marking shall be provided for continuous guidance to enable an aeroplane complete a 180° turn and align with the runway center line.

(2) The runway turn pad marking shall be curved from the runway center line into the turn pad.

(3) The radius of the curve shall be compatible with the manoeuvring capability and normal taxiing speeds of the aeroplanes for which the runway turn pad is intended.

(4) The intersection angle of the runway turn pad marking with the runway center line shall not be greater than 30°.

(5) The runway turn pad marking shall be extended parallel to the runway center line marking for a distance of at least 60m beyond the point of tangency where the code number is 3 or 4, and for a distance of at least 30m where the code number is 1 or 2.

(6) A runway turn pad marking shall guide the aeroplane in such a way as to allow a straight portion of taxiing before the point where a 180° turn is to be made.

(7) The straight portion of the runway turn pad marking shall be parallel to the outer edge of the runway turn pad.

(8) The design of the curve allowing the aeroplane to negotiate a 180° turn shall be based on a nose wheel steering angle not exceeding 45°.

(9) The design of the turn pad marking shall be such that when the cockpit of the aeroplane remains over the runway turn pad marking, the clearance distance between any wheel of the aeroplane landing gear and the edge of the runway shall not be less than that specified in regulation 94(5).

(10) A runway turn pad marking shall be at least 15cm in width and continuous in length.

#### **144. Runway-holding position marking**

(1) A runway-holding position marking shall be displayed along a runway-holding position.

(2) At an intersection of a taxiway and a non-instrument, non-precision approach or take-off runway, the runway holding position marking shall be as set out in Figure 11, pattern A.

(3) The runway holding position marking displayed at a runway- holding position established in accordance with regulation 107 (3) shall be as set out in Figure 11, pattern A.

(4) Where a single runway-holding position is provided at an intersection of a taxiway and a precision approach category I, II or III runway, the runway holding position marking shall be as set out in Figure 11, pattern A.

(5) Where two or three runway-holding positions are provided at such an intersection, the runway-holding position marking closest to the runway shall be as set out in Figure 11, pattern A and the markings farther from the runway shall be as set out in Figure 11, pattern B.

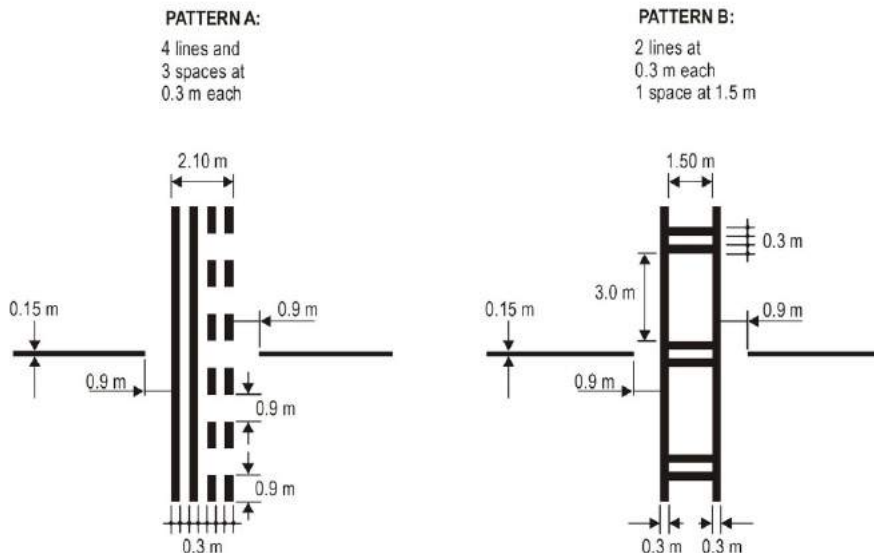
(6) Where a pattern B runway-holding position marking is located on an area where it would exceed 60m in length, the term “CAT II” or “CAT III” as appropriate shall be marked on the surface at the ends of the runway-holding position marking and at equal intervals of 45m maximum between successive marks.

(7) The letters shall be not less than 1.8m high and shall be placed not more than 0.9m beyond the holding position marking.

(8) The runway-holding position marking displayed at a runway or runway intersection shall be perpendicular to the center line of the runway forming part of the standard taxi-route.

(9) The pattern of the marking shall be as set out in the Figure 13 Pattern (A) below—

**Figure 13: Runway-holding position marking**



(10) The dimensions of runway holding position marking shall be as set out in Figure 13 Pattern (A) or (B) as appropriate.

#### **145. Intermediate holding position marking**

(1) An intermediate holding position marking shall be displayed along an intermediate holding position.

(2) Where an intermediate holding position marking is displayed at an intersection of two paved taxiways, it shall be—

- (a) located across the taxiway at sufficient distance from the near edge of the intersecting taxiway to ensure safe clearance between taxiing aircraft; and
- (b) coincident with a stop bar or intermediate holding position lights, where provided.

(3) An intermediate holding position marking shall consist of a single broken line as set out in Figure 11.

#### **146. VOR aerodrome checkpoint marking**

(1) Where a VOR aerodrome checkpoint is established, it shall be indicated by a VOR aerodrome checkpoint marking and sign.

(2) A selection of a site for a VOR aerodrome checkpoint shall be as set out in the Civil Aviation (Radio Navigation Aids) Regulations, 2022.

(3) A VOR aerodrome checkpoint marking shall be—

(a) centered on the spot at which an aircraft is to be parked to receive the correct VOR signal; and

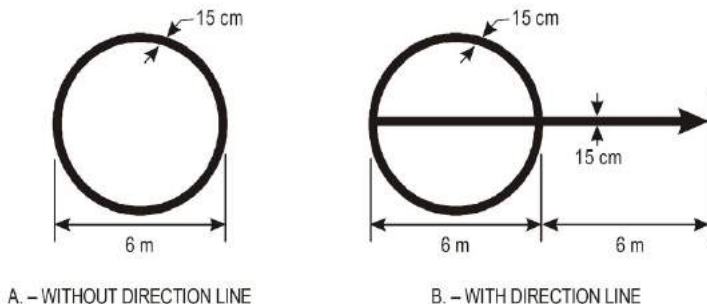
(b) shall consist of a circle of 6m in diameter and shall have a line width of 15cm as shown in figure 14A.

(4) Where it is preferable for an aircraft to be aligned in a specific direction, a line shall be provided that passes through the center of the circle on the desired azimuth.

(5) The line referred in to in subregulation (4) shall extend 6m outside the circle in the desired direction of heading and terminate in an arrowhead and the width of the line shall be 15cm as specified in Figure 14(B).

(6) A VOR aerodrome checkpoint marking shall preferably white in colour but should not differ from the colours used for taxiway markings.

**Figure 14. VOR aerodrome checkpoint marking**



*Note.— A direction line need only be provided when an aircraft must be aligned in a specific direction.*

### **147. Aircraft stand markings**

(1) Aircraft stand markings shall be provided for designated parking positions on a paved apron.

(2) Aircraft stand markings on a paved apron shall be located so as to provide the clearances specified in regulation 108(6) when the nose wheel follows the stand marking.

(3) Aircraft stand markings shall include such elements as stand identification, lead-in line, turn bar, turning line, alignment bar, stop line and lead-out line, as required by the parking configuration and to complement other parking aids.

(4) An aircraft stand identification letter or number shall be included in the lead-in line a short distance after the beginning of the lead-in line.

(5) The height of the identification shall be adequate to be readable from the cockpit of aircraft using the stand.

(6) Where two sets of aircraft stand markings are superimposed on each other in order to permit more flexible use of the apron and it is difficult to identify which stand marking should be followed, or

safety would be impaired if the wrong marking was followed, then identification of the aircraft for which each set of markings is intended shall be added to the stand identification.

(7) Lead-in, turning and lead-out lines shall normally be continuous in length and have a width of not less than 15cm.

(8) Where one or more sets of stand markings are superimposed on a stand marking, the lines shall be continuous for the most demanding aircraft and broken for other aircraft.

(9) The curved portions of lead-in, turning and lead-out lines shall have radii appropriate to the most demanding aircraft type for which the markings are intended.

(10) Where it is intended that an aircraft proceed in one direction only, arrows pointing in the direction to be followed shall be added as part of the lead-in and lead-out lines.

(11) A turn bar shall be located at right angles to the lead-in line, abeam the left pilot position at the point of initiation of any intended turn and shall have a length and width of not less than 6m and 15cm, respectively and, include an arrowhead to indicate the direction of turn.

(12) If more than one turn bar or stop line is required, they shall be coded.

(13) An alignment bar shall be placed so as to be coincident with the extended center line of the aircraft in the specified parking position and visible to the pilot during the final part of the parking manoeuver. It shall have a width of not less than 15cm.

(14) A stop line shall be located at right angles to the alignment bar, abeam the left pilot position at the intended point of stop and it shall have a length and width of not less than 6 m and 15cm, respectively.

#### **148. Apron safety lines**

(1) An aerodrome operator shall provide apron safety lines on a paved apron as required by the parking configuration and ground facilities.

(2) Apron safety lines shall be located to define the areas intended for use by ground vehicles and other aircraft servicing equipment, to provide safe separation from aircraft.

(3) Apron safety lines shall include such elements as wing tip clearance lines and service road boundary lines as required by the parking configurations and ground facilities.

(4) An apron safety line shall be continuous in length and at least 10cm in width.

#### **149. Road-holding position marking**

(1) An aerodrome operator shall provide road-holding position markings at all road entrances to a runway.

(2) The road-holding position marking provided under subregulation (1) shall be located across the road at the holding positions.

(3) The road holding position marking shall be in accordance with the national road traffic regulations, except that the colour yellow shall not be used in any airside road markings.

#### **150. Mandatory instruction marking**

(1) Where it is impracticable to install a mandatory instruction sign in accordance with regulation 203(1), a mandatory instruction marking shall be provided on the surface of the pavement.

(2) Where operationally required, such as on the taxiways exceeding 60m in width, or to assist in the prevention of a runway incursion, a mandatory instruction sign shall be supplemented by a mandatory instruction marking.

(3) The mandatory instruction marking on the taxiways where the code letter is A, B, C or D shall be located across the taxiway equally placed about the taxiway center line and on the holding side of the runway-holding position marking as set out in Figure 15(A) and the distance between the nearest edge of the marking and the runway-holding position marking or the taxiway center line marking shall not be less than 1m.

(4) The mandatory instruction marking on the taxiways where the code letter is E or F shall be located on both sides of the taxiway center line marking and on the holding side of the runway-holding position marking as shown in Figure 15 (B) and the distance between the nearest edge of the marking and the runway-holding position marking or the taxiway center line marking shall not be less than 1m.

(5) A mandatory instruction marking shall not be located on a runway, except where operationally required.

(6) A mandatory instruction marking shall consist of an inscription in white on a red background.

(7) Except for a “**NO ENTRY**” marking, the inscription shall provide information identical to that of the associated mandatory instruction sign.

(8) A “**NO ENTRY**” marking shall consist of an inscription in white reading NO ENTRY on a red background.

(9) Where there is insufficient contrast between the marking and the pavement surface, the mandatory instruction marking shall include an appropriate border, preferably white or black.

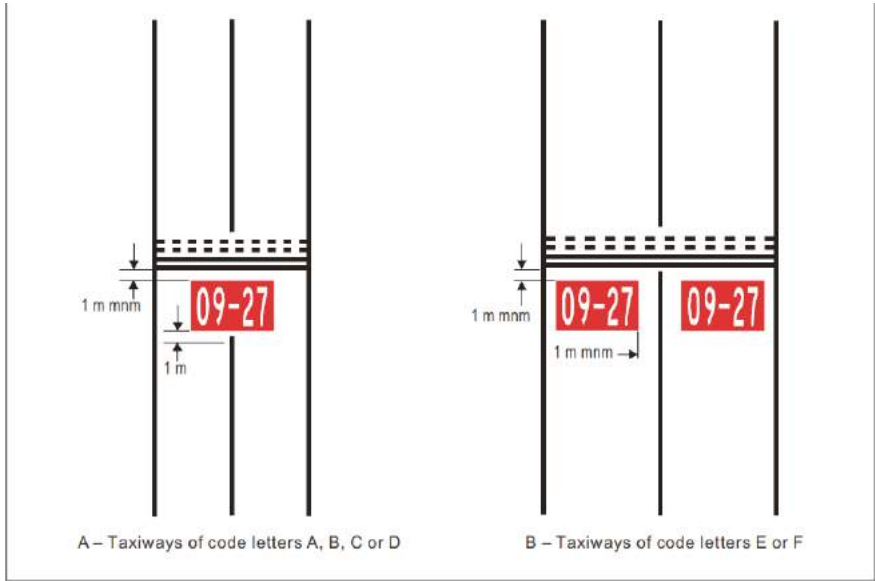
(10) The character height shall be 4m for inscriptions where the code letter is C, D, E or F, and 2m where the code letter is A or B.

(11) The inscriptions referred to in subregulation (10) shall be in the form and proportions set out in Schedule 5 to these Regulations.



(12) The background shall be rectangular and extend to a minimum of 0.5m laterally and vertically beyond the extremities of the inscription.

**Figure 15. Mandatory instruction marking**



### 151. Information marking

(1) An information marking shall be displayed on the surface of the pavement where an information sign is required but cannot be physically installed; as determined by the aerodrome operator.

(2) Where operationally required, an information sign shall be supplemented by an information marking.

(3) An information location or direction marking shall, be displayed prior to and following complex taxiway intersections and where operational experience has indicated the addition of a taxiway, location marking will assist flight crew ground navigation.

(4) A location information marking shall be displayed on the pavement surface at regular intervals along the taxiways of great length.

(5) The information marking shall be displayed across the surface of the taxiway or apron where necessary and positioned so as to be legible from the cockpit of an approaching aircraft.

(6) An information marking shall consist of—

(a) an inscription in yellow upon a black background, where it replaces or supplements a location sign; and

(b) an inscription in black upon a yellow background, where it replaces or supplements a direction or destination sign.

(7) Where there is insufficient contrast between the marking background and the pavement surface, the marking shall include—

(a) a black border where the inscriptions are in black; and

(b) a yellow border where the inscriptions are in yellow.

(8) The character height of an information marking shall be 4m and the inscriptions shall be in the form and proportions set out in Schedule 5 to these Regulations.

## **152. Establishment of aeronautical ground lights**

(1) An aerodrome operator shall establish and maintain aeronautical ground lights and other lights appropriate for the safe operation of an aircraft, for runways, taxiways, aprons, thresholds and stopways.

(2) Where an aerodrome is used at night or during conditions of poor visibility, an operator shall ensure that aeronautical ground lights and any other lights are installed on the aerodrome.

(3) Without prejudice to the generality of subregulation (1), the location, characteristics, intensity control and settings of the aeronautical ground lights, shall be in accordance with these Regulations.

(4) A person shall not interfere with an aeronautical ground light without the permission of the aerodrome operator.

**153. Lights which may endanger safety of aircraft**

(1) A person shall not exhibit a light in the vicinity of an aerodrome which, by its glare, endangers the safety of aircraft arriving or departing from the aerodrome.

(2) A non-aeronautical ground light near an aerodrome which might endanger the safety of aircraft shall be extinguished, screened or otherwise modified.

(3) Where a light appears to be capable of endangering the safety of an aircraft as described in subregulation (1), the authority may direct the owner of the place where the light is exhibited or the person having charge of the light to extinguish and to prevent in the future, the exhibition of the light within a specified period.

**154. Laser emissions which may endanger safety of aircraft**

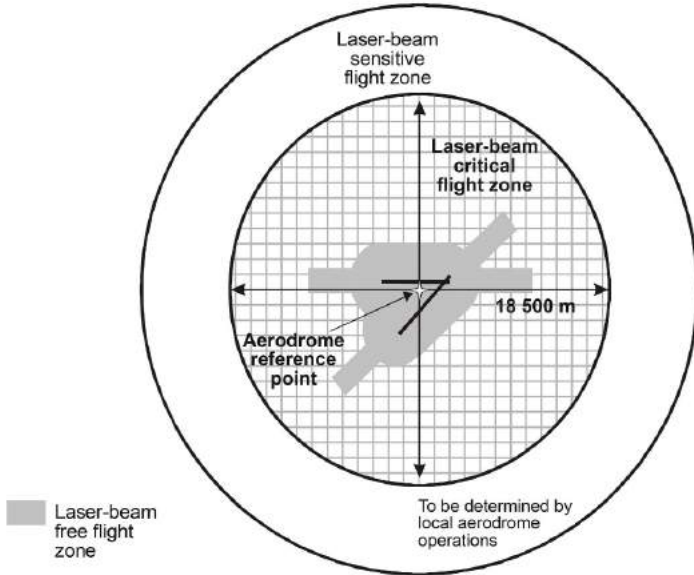
(1) A person shall not use laser emissions which are likely to endanger the safety of aircraft.

(2) To protect the safety of aircraft against the hazardous effects of laser emitters, the following protected zones shall be established around aerodromes—

- (a) a laser-beam free flight zone (LFFZ);
- (b) a laser-beam critical flights zone (LCFZ); and
- (c) a laser-beam sensitive flight zone.

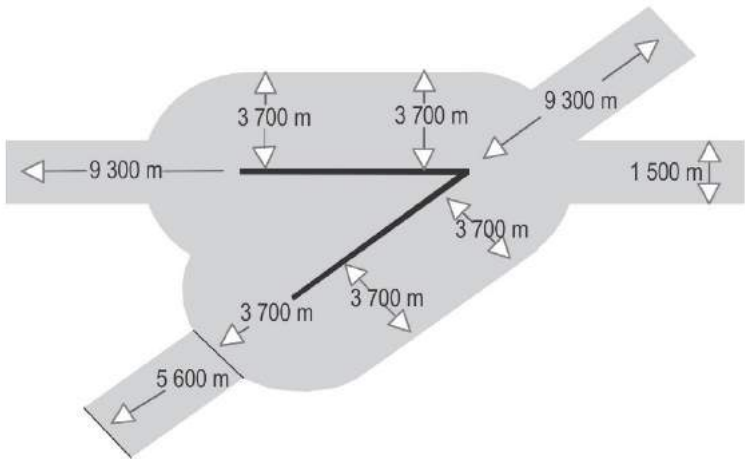
(3) The flight zones referred to in subregulation (2) shall be established as indicated in Figures 16, 17 and 18.

**Figure 16 protected flight zones**



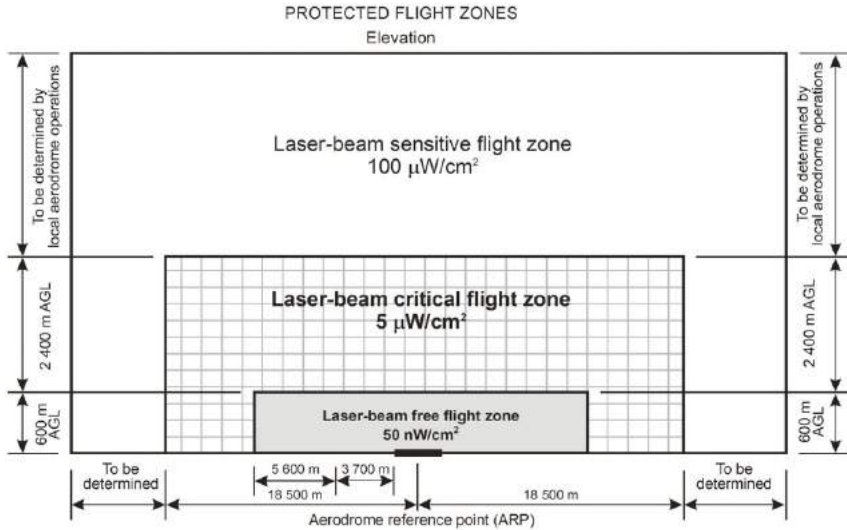
*Note.— The dimensions indicated are given as guidance only.*

**Figure 17: multiple runway laser-beam free zone**



*Note.— The dimensions indicated are given as guidance only.*

**Figure 18: Protected flight zones with indication of maximum irradiance levels for laser beams**



**155. Lights which may cause confusion**

A non-aeronautical ground light which, by reason of its intensity, configuration or colour, might prevent, or cause confusion in, the clear interpretation of aeronautical ground lights shall be extinguished, screened or otherwise modified so as to eliminate such a possibility and particular attention shall be directed to a non-aeronautical ground light visible from the air within the areas described in this regulation—

- (a) instrument runway code number 4 within the areas before the threshold and beyond the end of the runway extending at least 4,500m in length from the threshold and runway end and 750m either side of the extended runway center line in width;
- (b) instrument runway code number 2 or 3 as stipulated in paragraph (a), except that the length shall be at least 3,000m; and

- (c) instrument runway code number 1; and non-instrument runway;

within the approach area.

### **156. Elevated approach lights**

(1) The elevated approach lights and their supporting structures shall be frangible except that, in that portion of the approach lighting system beyond 300m from the threshold—

- (a) where the height of a supporting structure exceeds 12m, the frangibility requirement shall apply to the top 12m only; and
- (b) where a supporting structure is surrounded by non-frangible objects, only that part of the structure that extends above the surrounding objects shall be frangible.

(2) Where an approach light fixture or supporting structure is not in itself sufficiently conspicuous, it shall be suitably marked.

### **157. Elevated lights**

Elevated runway, stopway and taxiway lights shall be frangible and their height shall be sufficiently low to preserve clearance for propellers and for the engine pods of a jet aircraft.

### **158. Surface lights**

(1) The light fixtures inset in the surface of runways, stopways, taxiways and aprons shall be so designed and fitted as to withstand being run over by the wheels of an aircraft without damage either to the aircraft or to the lights themselves.

(2) The temperature produced by conduction or radiation at the interface between an installed inset light and an aircraft tyre shall not exceed 160°C during a 10 minute period of exposure.

### **159. Light intensity and control**

(1) The intensity of runway lighting shall be adequate for the minimum conditions of visibility and ambient light for which use of

the runway is intended and shall be compatible with that of the nearest section of the approach lighting system where provided.

(2) Where a high-intensity lighting system is provided, a suitable intensity control shall be incorporated to allow for adjustment of the light intensity to meet the prevailing conditions.

(3) Separate intensity controls or other suitable methods shall be provided to ensure that the following systems, when installed, can be operated at compatible intensities—

- (a) approach lighting system;
- (b) runway edge lights;
- (c) runway threshold lights;
- (d) runway end lights;
- (e) runway center line lights;
- (f) runway touchdown zone lights; and
- (g) taxiway center line lights.

(4) On the perimeter of and within the ellipse defining the main beam in Figure S4-1 to S4-10 of Schedule 4 to these Regulations, the maximum light intensity value shall not be greater than three times the minimum light intensity value measured in accordance with the requirements in Figure S4-1 to S4-11 and S4-26 of Schedule 4 to these Regulations.

(5) On the perimeter of and within the rectangle defining the main beam in Schedule 4 to these Regulations, the maximum light intensity value shall not be greater than three times the minimum light intensity value measured in accordance with the requirements in Figure S4-12 to S4-21 of Schedule 4 to these Regulations.

## **160. Emergency lighting**

(1) At an aerodrome provided with runway lighting and without a secondary power supply, sufficient emergency lights shall be available for installation on the primary runway in the event of failure of the normal lighting system.

(2) Where installed on a runway the emergency lights shall, as a minimum, conform to the configuration required for a non-instrument runway.

(3) The colour of the emergency lights shall conform to the colour requirements for runway lighting, except that, where the provision of coloured lights at the threshold and the runway end is not practicable, all lights may be a variable white or as close to variable white as practicable.

## **161. Aeronautical beacons**

(1) Where operationally necessary, an aerodrome beacon or an identification beacon shall be provided at each aerodrome intended for use at night.

(2) The operational requirements of an aerodrome shall be determined having regard to the requirements of the air traffic using the aerodrome, the conspicuity of the aerodrome features in relation to its surroundings and the installation of other visual and non-visual aids useful in locating the aerodrome.

## **162. Aerodrome beacon**

(1) An aerodrome beacon shall be provided at every aerodrome intended for use at night where one or more of the following conditions exist—

- (a) aircraft navigate predominantly by visual means;
- (b) reduced visibilities are frequent; or
- (c) it is difficult to locate the aerodrome from the air due to surrounding lights or terrain.



(2) The aerodrome beacon shall be located on or adjacent to the aerodrome in an area of low ambient back-ground lighting.

(3) The location of the beacon shall be such that the beacon is not shielded by any objects in the significant directions and does not dazzle a pilot approaching to land.

(4) The aerodrome beacon shall show either coloured flashes alternating with white flashes or white flashes only.

(5) The frequency of total flashes shall range from 20 to 30 flashes per minute.

(6) Where used, the coloured flashes emitted by beacons at land aerodromes shall be green and the coloured flashes emitted by beacons at water aerodromes shall be yellow.

(7) In the case of a combined water and land aerodrome, coloured flashes, where used, shall have the colour characteristics of the respective section of the aerodrome designated as the principal facility.

(8) The light from the beacon shall show at all angles of azimuth.

(9) The vertical light distribution shall extend upwards from an elevation of not more than  $1^{\circ}$  to an elevation determined by the authority as sufficient to provide guidance at the maximum elevation at which the beacon is intended to be used and the effective intensity of the flash shall not be less than 2,000cd.

### **163. Identification beacon**

(1) An identification beacon shall be provided at every aerodrome which is intended for use at night and cannot be easily identified from the air by other means.

(2) The identification beacon shall be located on the aerodrome in an area of low ambient background lighting.

(3) The location of the beacon shall be such that the beacon is not shielded by objects in all directions and does not dazzle a pilot approaching to land.

(4) An identification beacon at a land aerodrome shall show at all angles of azimuth.

(5) The vertical light distribution shall extend upwards from an elevation of not more than  $1^\circ$  to an elevation determined by the authority as sufficient to provide guidance at the maximum elevation at which the beacon intended to be used and the effective intensity of the flash shall be not less than 2,000cd.

(6) An identification beacon shall show flashing-green at a land aerodrome and flashing-yellow at a water aerodrome.

(7) The identification characters shall be transmitted in International Morse Code.

(8) The speed of transmission shall be between six and eight words per minute, the corresponding range of duration of the Morse dots being from 0.15 to 0.2 seconds per dot.

#### **164. Approach lighting system**

(1) Where physically practicable, the simple approach lighting system referred to in regulation 165 shall be provided and shall serve a non-instrument runway, where the code number is 3 or 4 and intended for use at night, except where the runway is used only in conditions of good visibility and sufficient guidance is provided by other visual aids.

(2) Where physically practicable, a simple approach lighting system as in regulation 165 shall be provided to serve a non-precision

approach runway, except when the runway is used only in conditions of good visibility or sufficient guidance is provided by other visual aids.

(3) Where physically practicable, a precision approach category I lighting system as set out in regulation 166 shall be provided to serve a precision approach runway Category I.

(4) A precision approach runway of Category II and III lighting system referred to in regulation 167 shall be provided to serve a precision approach runway Category II or III.

### **165. Simple approach lighting system**

(1) A simple approach lighting system shall consist of a row of lights on the extended center line of the runway extending, whenever possible, over a distance of not less than 420m from the threshold and with a row of lights forming a crossbar 18m or 30m in length at a distance of 300m from the threshold.

(2) The lights forming the crossbar shall be as near as practicable in a horizontal straight line at right angles to and bisected by, the line of the center line lights.

(3) The lights of the crossbar shall be spaced so as to produce a linear effect, except that, where a crossbar of 30m is used, gaps may be left on each side of the center line.

(4) The gaps referred to in subregulation (3) shall be kept to a minimum to meet the local requirements and each shall not exceed 6m.

(5) The lights forming the center line shall be placed at longitudinal intervals of 60m, except that, where it is desired to improve the guidance, an interval of 30m may be used.

(6) The innermost light shall be located either 60m or 30m from the threshold, depending on the longitudinal interval selected for the center line lights.

(7) Where it is not physically possible to provide a center line extending for a distance of 420m from the threshold, the center line shall be extended to 300m so as to include the crossbar.

(8) Subject to subregulation (7) the center line lights shall be extended as far as practicable and, each center line light shall then consist of a barrette at least 3m in length.

(9) Subject to the approach system having a crossbar at 300m from the threshold, an additional crossbar may be provided at 150m from the threshold.

(10) The approach system shall lie as nearly as practicable in the horizontal plane passing through the threshold, provided that—

- (a) no object other than an ILS azimuth antenna shall protrude through the plane of the approach lights within a distance of 60 m from the center line of the system; and
- (b) no light other than a light located within the central part of a crossbar or a center line barrette and not their extremities, shall be screened from an approaching aircraft.

(11) Any ILS azimuth antenna protruding through the plane of the lights shall be treated as an obstacle and marked and lit accordingly.

(12) The lights of a simple approach lighting system shall be fixed lights and the colour of the lights shall be such that the system is readily distinguishable from other aeronautical ground lights, and from extraneous lighting if present.

(13) Each center line light shall consist of either—

- (a) a single source; or
- (b) a barrette at least 3m in length.

(14) Where provided for a non-instrument runway, the lights shall show at all angles in azimuth necessary for a pilot on base leg and final approach.

(15) The intensity of the lights shall be adequate for all conditions of visibility and ambient light for which the system has been provided.

(16) Where provided for a non-precision approach runway, the lights shall show at all angles in azimuth necessary for a pilot of an aircraft which on final approach does not deviate by an abnormal amount from the path defined by the non-visual aid.

(17) The lights shall be designed to provide guidance during both day and night in the most adverse conditions of visibility and ambient light for which it is intended that the system shall remain usable.

#### **166. Precision approach Category I lighting system**

(1) A precision approach Category I lighting system shall consist of a row of lights on the extended center line of the runway extending, wherever possible, over a distance of 900m from the runway threshold with a row of lights forming a crossbar of 30m in length at a distance of 300m from the runway threshold.

(2) The lights forming the crossbar shall be as nearly as practicable in a horizontal straight line—

- (a) at right angles to the line of the center line lights; and
- (b) bisected by, the line of the center line lights.

(3) The lights of the crossbar shall be spaced so as to produce a linear effect, except that, gaps may be left on each side of the center line and these gaps shall be kept to a minimum to meet aerodrome requirements and each gap shall not exceed 6m.

(4) The lights forming the center line shall be placed at longitudinal intervals of 30m, with the innermost light located 30m from the threshold.

(5) The precision approach Category I lighting system shall lie as nearly as practicable in the horizontal plane that runs through the threshold, provided that—

- (a) no object other than an ILS antenna shall protrude through the plane of the approach lights within a distance of 60 m from the center line of the system; and
- (b) no light other than a light located within the central part of a crossbar or a center line barrette, nor their extremities, shall be screened from an approaching aircraft.

(6) Any ILS azimuth antenna protruding through the plane of the lights shall be treated as an obstacle and marked and lit accordingly.

(7) The center line and crossbar lights of a precision approach category I lighting system shall be fixed lights showing variable white and each center line light position shall consist of either—

- (a) a single light source in the innermost 300m of the center line, two light sources in the central 300m of the center line and three light sources in the outer 300m of the center line to provide distance information; or
- (b) a barrette.

(8) Where the serviceability level of the approach lights specified as a maintenance objective in regulation 281(15) can be demonstrated, each center line light position may consist of either—

- (a) a single light source; or
- (b) a barrette.

(9) The barrettes referred to in subregulations (2) and (8) shall not be at less than 4m in length and when they are composed of lights approximating to point sources, the lights shall be uniformly spaced at intervals of not more than 1.5m.

(10) Where the center line consists of barrettes as set out in subregulations (7)(b) or (8) (b), each barrette shall be supplemented by a flashing light, except where such lighting is considered unnecessary taking into account the characteristics of the system and the nature of the meteorological conditions.

(11) Each flashing light referred to in subregulation (10) shall be flashed twice a second in sequence, beginning with the outermost light and progressing toward the threshold to the innermost light of the system.

(12) The design of the electrical circuit for the lights referred to in subregulation (11) shall be such that the lights can be operated independently of the other lights of the approach lighting system.

(13) Where the center line consists of lights referred to in subregulation (7)(a) or (8)(a), additional crossbars of lights to the crossbar provided at 300m from the threshold shall be provided at 150m, 450m, 600m and 750m from the threshold.

(14) The lights forming each crossbar referred to in subregulation (13) shall be as near as practicable in a horizontal straight line at right angles to, and bisected by, the line of the center line lights.

(15) The lights referred to in subregulation (13) shall be spaced so as to produce a linear effect, except that gaps may be left on each side of the center line and the gaps shall be kept to a minimum to meet aerodrome requirements and each shall not exceed 6m.

(16) Where additional crossbars referred to in subregulation (13) are incorporated into the system, the outer ends of the crossbars shall be on two straight lines that either are parallel to the line of the center line lights or converge to meet the runway center line 300m, from the threshold.

(17) The lights shall be in accordance with the specifications set out in Figure S4-1 of Schedule 4 to these Regulations.

### **167. Precision approach Category II and III lighting system**

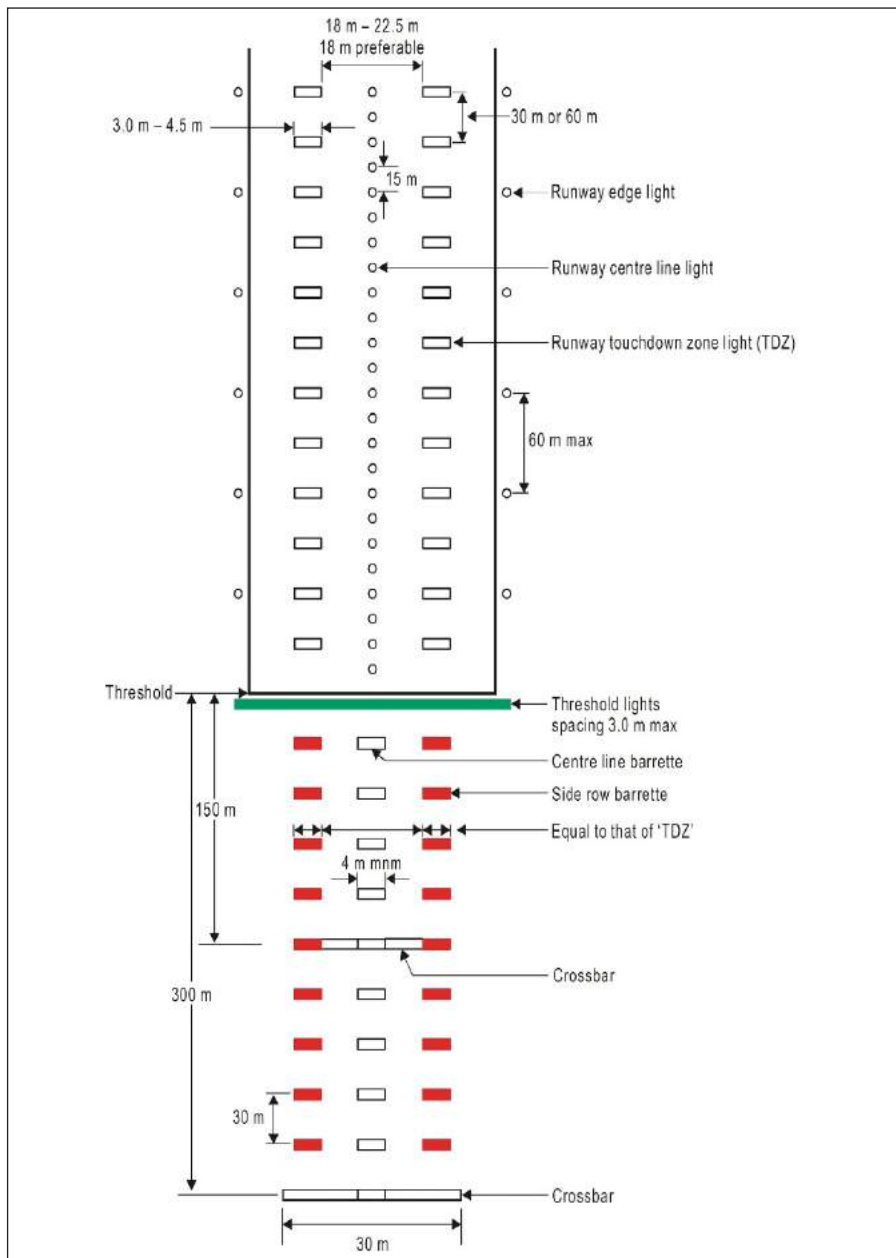
(1) The approach lighting system shall consist of a row of lights on the extended center line of the runway, extending, wherever possible, over a distance of 900m from the runway threshold.

(2) The approach lighting system shall have two side rows of lights, extending 270m from the threshold, and two crossbars, one at 150m and one at 300m from the threshold, as set out in Figure 19.

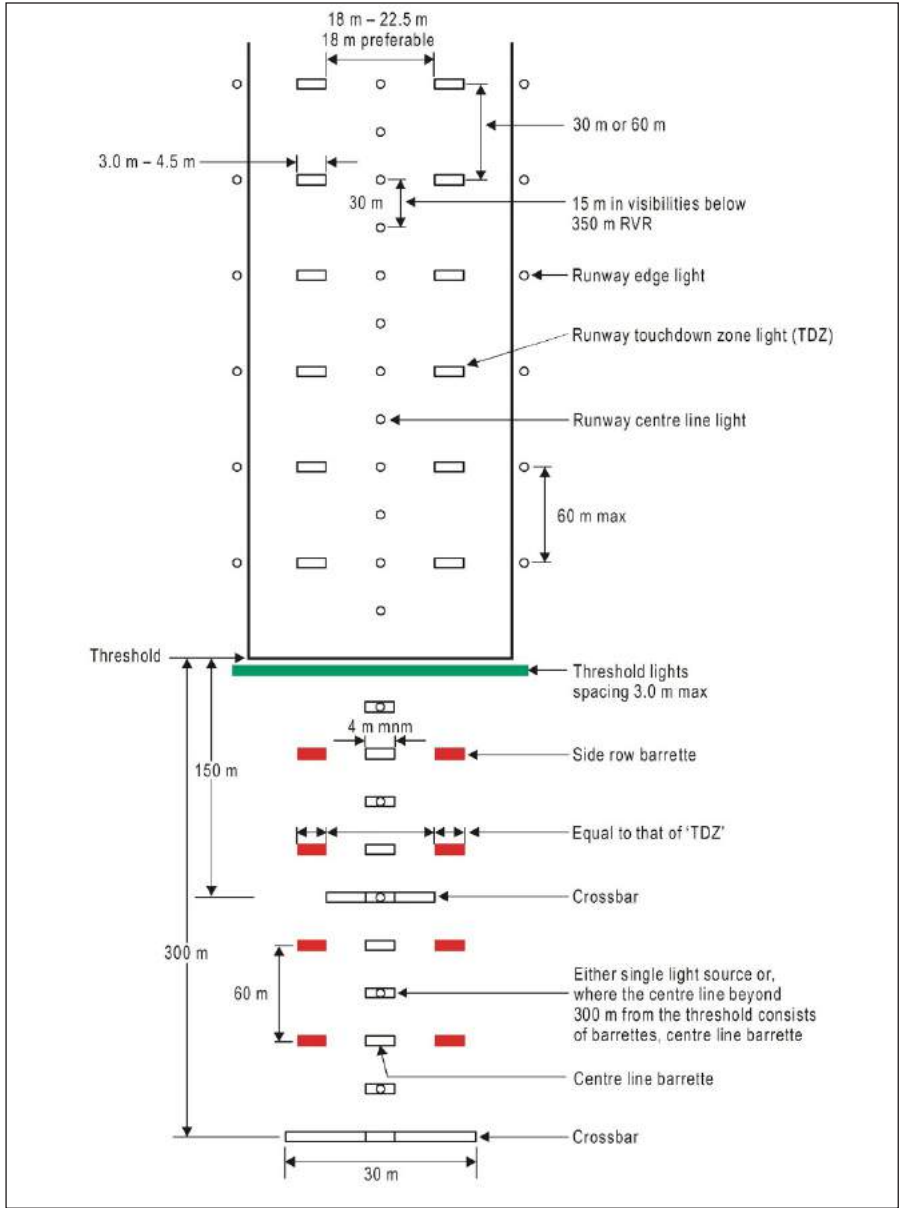
(3) Where the serviceability level of the approach lights specified as maintenance objectives in Regulation 281(9) can be demonstrated, the system may have two side rows of lights, extending 240m from the threshold, and two crossbars, one at 150m and one at 300m from the threshold as set out in Figure 20.



**Figure 19; Inner 300m approach and runway lighting for precision approach runways, categories II and III**



**Figure 20; Inner 300 m approach and runway lighting for precision approach runways, categories II and III, where the serviceability levels of the lights specified as maintenance objectives in Part XVI can be demonstrated**



(4) The lights forming the center line shall be placed at longitudinal intervals of 30m with the innermost lights located 30m from the threshold.

(5) The lights forming the side rows shall be placed on each side of the center line, at a longitudinal spacing equal to that of the center line lights and with the first light located 30m from the threshold.

(6) Where the serviceability level of the approach lights specified as maintenance objectives in regulation 281(9), can be demonstrated, lights forming the side rows may be placed on each side of the center line, at a longitudinal spacing of 60m with the first light located 60m from the threshold.

(7) The lateral spacing or gauge between the innermost lights of the side rows shall not be less than 18m nor more than 22.5m, and preferably 18m, but in any event shall be equal to that of the touchdown zone lights.

(8) The crossbar provided at 150m from the threshold shall fill in the gaps between the center line and side row lights.

(19) The crossbar provided at 300m from the threshold shall extend on both sides of the center line lights to a distance of 15m from the center line.

(10) Where the center line beyond a distance of 300m from the threshold consists of lights as set out in subregulation (16) (b) or 17 (b), additional crossbars of lights shall be provided at 450m, 600 m and 750m from the threshold.

(11) Where the additional crossbars set out in subregulation (10) are incorporated in the system, the outer ends of the crossbars shall lie on two straight lines that either are parallel to the center line or converge to meet the runway center line 300m from the threshold.

(12) The system shall lie as near as practicable in the horizontal plane that runs through the threshold, provided that—

- (a) no object other than an ILS azimuth antenna shall protrude through the plane of the approach lights within a distance of 60m from the center line of the system; and
- (b) no light other than a light located within the central part of a crossbar or a center line barrette, nor their extremities, shall be screened from an approaching aircraft.

(13) Any ILS azimuth antenna protruding through the plane of the lights shall be treated as an obstacle and shall be marked and lit accordingly.

(14) The center line of a precision approach category II and III lighting system for the first 300 m from the threshold shall consist of barrettes showing variable white, except that, where the threshold is displaced 300m or more, the center line may consist of single light sources showing variable white.

(15) Where the serviceability level of the approach lights specified as maintenance objectives in regulation 281(9) can be demonstrated, the center line of a precision approach category II and III lighting system for the first 300m from the threshold may consist of either—

- (a) barrettes, where the center line beyond 300m from the threshold consists of barrettes as set out in subregulation (17) (a);
- (b) alternate single light sources and barrettes, where the center line beyond 300m from the threshold consists of single light sources as described in subregulation (17) (b) with the innermost single light source located 30m and the innermost barrette located 60m from the threshold; or
- (c) single light sources where the threshold is displaced 300m or more;

all of which shall show variable white.

(16) Beyond 300m from the threshold each center line light position shall consist of either—

- (a) a barrette as used on the inner 300m; or
- (b) two light sources in the central 300m of the center line and three light sources in the outer 300m of the center line;

all of which shall show variable white.

(17) Where the serviceability level of the approach lights set out as maintenance objectives regulation 281(9) can be demonstrated beyond 300m from the threshold, each center line light position may consist of either —

- (a) a barrette; or
- (b) a single light source;

all of which shall show variable white.

(18) The barrettes shall not be less than 4m in length and when composed of lights approximating to point sources, the lights shall be uniformly spaced at intervals of not more than 1.5m.

(19) Where the center line beyond 300m from the threshold consists of barrettes as set out in subregulation 16(a) or 17(a), each barrette beyond 300m shall be supplemented by a flashing light, except where such lighting is considered unnecessary taking into account the characteristics of the system and the nature of the meteorological conditions.

(20) Each flashing light referred to in subregulation (19) shall be flashed twice a second in sequence, beginning with the outermost light and progressing toward the threshold to the innermost light of the system and the design of the electrical circuit shall be such that these lights can be operated independently of the other lights of the approach lighting system.

(21) The side row shall consist of barrettes showing red and the length of a side row barrette and the spacing of its lights shall be equal to those of the touchdown zone light barrettes.

(22) The lights forming the crossbars shall be fixed lights showing variable white and shall be uniformly spaced at intervals of not more than 2.7m.

(23) The intensity of the red lights shall be compatible with the intensity of the white lights and the lights shall conform to the specifications set out in Schedule 4 figures S4-1 and S4-2 in Schedule 4 to these Regulations.

## **168. Visual approach slope indicator systems**

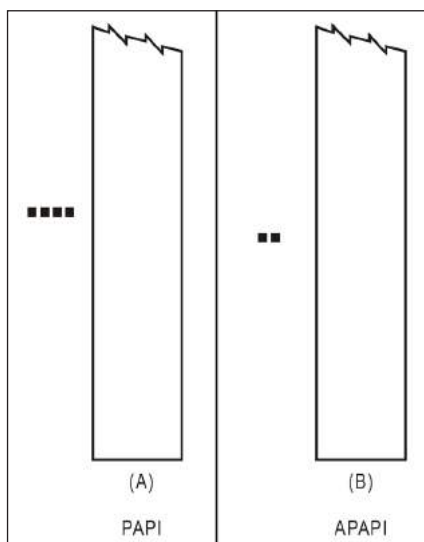
(1) A visual approach slope indicator system shall be provided to serve the approach to a runway whether or not the runway is served by other visual approach aids or by non-visual aids, where one or more of the following conditions exist—

- (a) the runway is used by turbojet or other aeroplanes with similar approach guidance requirements;
- (b) the pilot of any type of aeroplane has difficulty in judging the approach due to—
  - (i) inadequate visual guidance such as is experienced during an approach over water or featureless terrain by day or in the absence of sufficient extraneous lights in the approach area by night; or
  - (ii) misleading information produced by deceptive surrounding terrain or runway slopes;
- (c) the presence of objects in the approach area that may involve serious hazard in case an aeroplane descends below the normal approach path, particularly if there are no non-visual or other visual aids to give warning of such objects;

- (d) physical conditions at either end of the runway present a serious hazard in the event of an aeroplane undershooting or overrunning the runway; and
- (e) terrain or prevalent meteorological conditions are such that the aeroplane may be subjected to unusual turbulence during approach.

(2) The standard visual approach slope indicator systems shall consist of PAPI and APAPI systems as appropriate conforming to the specifications in regulations 169 and 170, as set out in Figure 21.

**Figure 21. Visual approach slope indicator system**



(3) PAPI shall be provided where the code number is 3 or 4 where one or more of the conditions specified in subregulation (1) exist.

(4) PAPI or APAPI shall be provided where the code number is 1 or 2 and where one or more of the conditions specified in subregulation (1) exist.

(5) Where a runway threshold is temporarily displaced from the normal position and one or more of the conditions specified in subregulation (1) exist, a PAPI shall be provided except that where the code number is 1 or 2, an APAPI may be provided instead.

## 169. PAPI and APAPI

(1) The PAPI system shall consist of a wing bar of four sharp transition multi-lamp or paired single lamp units equally spaced and shall be located on the left side of the runway except where it is physically impracticable to do so.

(2) The APAPI system shall consist of a wing bar of two sharp transition multi-lamp or paired single lamp units and shall be located on the left side of the runway unless it is physically impracticable to do so.

(3) The wing bar of a PAPI shall be constructed and arranged in such a manner that a pilot making an approach will—

- (a) when on or close to the approach slope, see the two units nearest the runway as red and the two units farthest from the runway as white;
- (b) when above the approach slope, see the one unit nearest the runway as red and the three units farthest from the runway as white and; when further above the approach slope, see all the units as white; and
- (c) when below the approach slope, see the three units nearest the runway as red and the unit farthest from the runway as white and; when further below the approach slope, see all the units as red.

(4) The wing bar of an APAPI shall be constructed and arranged in such a manner that a pilot making an approach will—

- (a) when on or close to the approach slope, see the unit nearer the runway as red and the unit farther from the runway as white;
- (b) when above the approach slope, see both the units as white; and
- (c) when below the approach slope, see both the units as red.

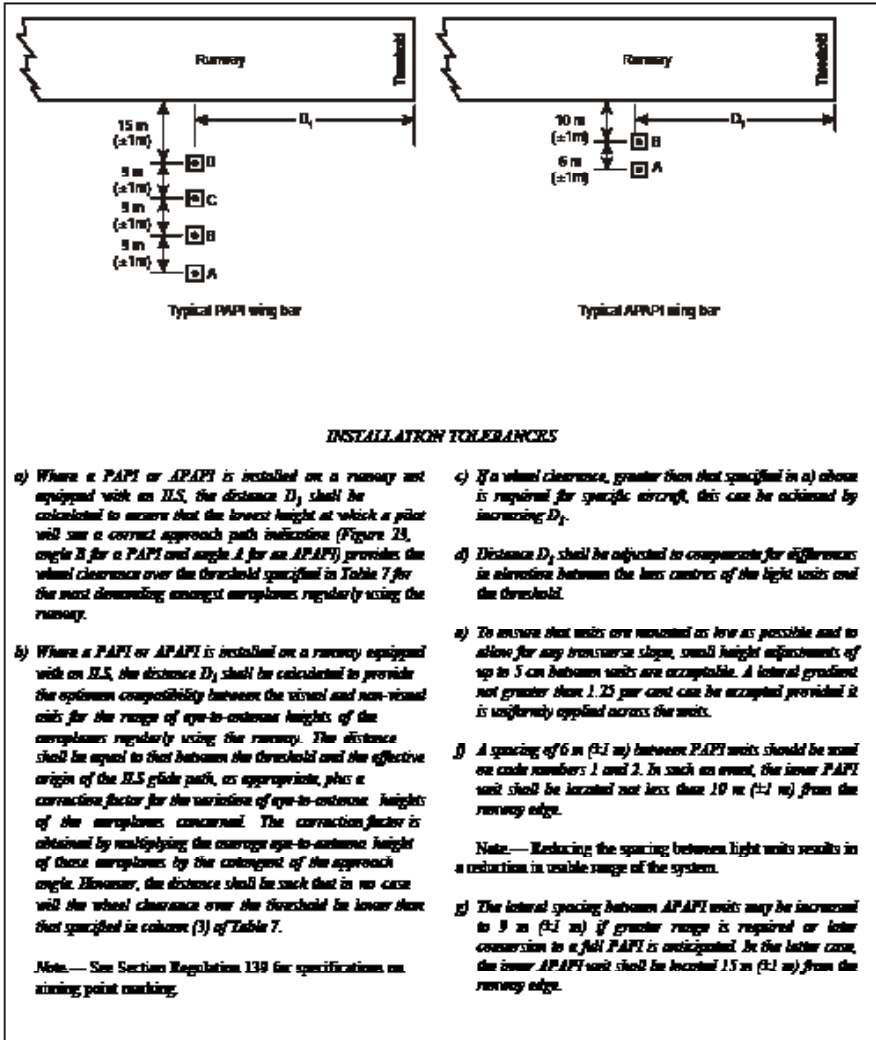
(5) The light units shall be located as the basic configuration set out in the Figure 22, subject to the installation tolerances given therein.



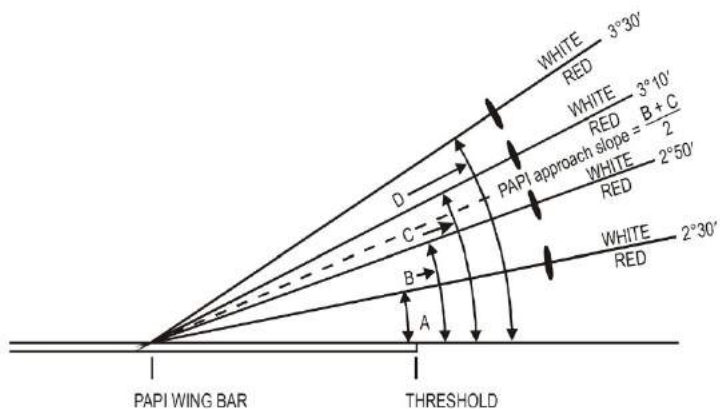
(6) The units forming a wing bar shall be mounted to appear to the pilot of an approaching aeroplane to be substantially in a horizontal line.

(7) The light units shall be mounted as low as possible and shall be frangible.

Figure 22 Siting of PAPI and APAPI

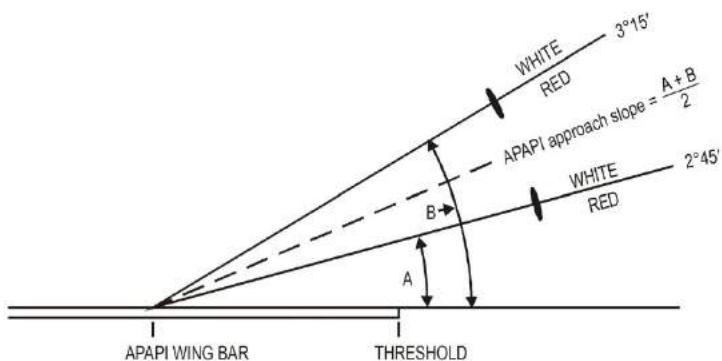


**Figure 23. Light beams and angle of elevation setting of PAPI and APAPI**



The height of the pilot's eye above the aircraft's ILS glide path/MLS antenna varies with the type of aeroplane and approach attitude. Harmonization of the PAPI signal and ILS glide path and/or MLS minimum glide path to a point closer to the threshold may be achieved by increasing the on-course sector from 20' to 30'. The setting angles for a 3° glide slope would then be 2°25', 2°45', 3°15' and 3°35'.

A — 3° PAPI ILLUSTRATED



B — 3° APAPI ILLUSTRATED

The height of the pilot’s eye above the path antenna varies with the type of aeroplane and its approach attitude. Similarly, aeroplanes flying an approach using a nominal glide path determined by the aircraft’s altimeter will experience altimeter error at different ambient temperatures. Such approaches include GNSS, PBN, VOR/DME, GP inoperative. Uganda’s aerodrome reference and actual temperatures are normally well above ISA, therefore the aeroplane will fly a steeper approach than the nominal glidepath, e.g. of 3 degrees. Harmonisation of the PAPI beams and ILS or nominal glidepaths to a point closer to the threshold will be achieved by increasing the on-course PAPI sector from 20 to 30 of arc. The setting angles for a 3° glide slope would then be 2°25’, 2°45’, 3°15’and 3°35’.

**Table 7: Wheel clearance over threshold for PAPI and APAPI**

Eye-to-wheel height of aeroplane in the approach configuration <sup>a</sup>  (1)	Required wheel clearance (meters) b,c (2)	Minimum wheel clearance (meters) <sup>d</sup> (3)
up to but not including 3 m	6	3 <sup>e</sup>
3 m up to but not including 5 m	9	4
5 m up to but not including 8 m	9	5
8 m up to but not including 14 m	9	6
<p><sup>a</sup> In selecting the eye-to-wheel height group, only aeroplanes meant to use the system on a regular basis shall be considered. The most demanding amongst such aeroplanes shall determine the eye-to- wheel height group.</p> <p><sup>b</sup> Where practicable the desired wheel clearances set out in column (2) shall be provided.</p> <p><sup>c</sup> The wheel clearances in column (2) may be reduced to no less than those in column (3) where an aeronautical study indicates that such reduced wheel clearances are acceptable.</p> <p><sup>d</sup> When a reduced wheel clearance is provided at a displaced threshold it shall be ensured that the corresponding desired wheel clearance specified in column (2) will be available when an aeroplane at the top end of the eye-to-wheel height group chosen overflies the extremity of the runway.</p> <p><sup>e</sup> This wheel clearance may be reduced to 1.5 m on runways used mainly by light-weight non-turbojet aeroplanes.</p>		



(8) The system shall be suitable for both day and night operations.

(9) The colour transition from red to white in the vertical plane shall appear to an observer, at a distance of not less than 300m, to occur within a vertical angle of not more than 3°.

(10) At full intensity the red light shall have a Y coordinate not exceeding 0.320.

(11) Suitable intensity control shall be provided to allow adjustment to meet the prevailing conditions and to avoid dazzling the pilot during approach and landing.

(12) Each light unit shall be capable of adjustment in elevation so that the lower limit of the white part of the beam may be fixed at any desired angle of elevation between 1°30' and at least 4°30' above the horizontal.

(13) The light units shall be so designed that deposits including, condensation and dirt on optically transmitting or reflecting surfaces shall interfere to the least possible extent with the light signals and shall not affect the contrast between the red and white signals and the elevation of the transition sector.

(14) The light intensity distribution of the light units shall be as set out in Figure S4-23 of Schedule 4 to these Regulations.

**170. Approach slope and elevation setting of light units for PAPI and APAPI**

(1) The approach slope set out in Figure 23 shall be appropriate for use by the aeroplanes using the approach.

(2) When the runway is equipped with an ILS, the siting and the angle of elevation of the light units shall be such that the visual

approach slope conforms as closely as possible with the glide path of the ILS.

(3) The angle of elevation settings of the light units in a PAPI wing bar shall be such that, during an approach, the pilot of an aeroplane observing a signal of one white and three reds will clear all objects in the approach area by a safe margin set out in table 7.

(4) The angle of elevation settings of the light units in an APAPI wing bar shall be such that, during an approach, the pilot of an aeroplane observing the lowest on slope signal, that is one white and one red, will clear all objects in the approach area by a safe margin as set out in table 7.

(5) The azimuth spread of the light beam shall be suitably restricted where an object located outside the obstacle protection surface of the PAPI or APAPI system, but within the lateral limits of its light beam, is found to extend above the plane of the obstacle protection surface and an aeronautical study indicates that the object could adversely affect the safety of operations.

(6) The extent of the restriction shall be such that the object remains outside the confines of the light beam.

(7) Where wing bars are installed on each side of the runway to provide roll guidance, corresponding units shall be set at the same angle so that the signals of each wing bar change symmetrically at the same time.

### **171. Obstacle protection surface for PAPI and APAPI**

(1) An Obstacle Protection Surface (OPS) shall be established where it is intended to provide a visual approach slope indicator system.

(2) The characteristics of the OPS, that is origin, divergence, length and slope, shall correspond to those set out in table 8 and in Figure 24.

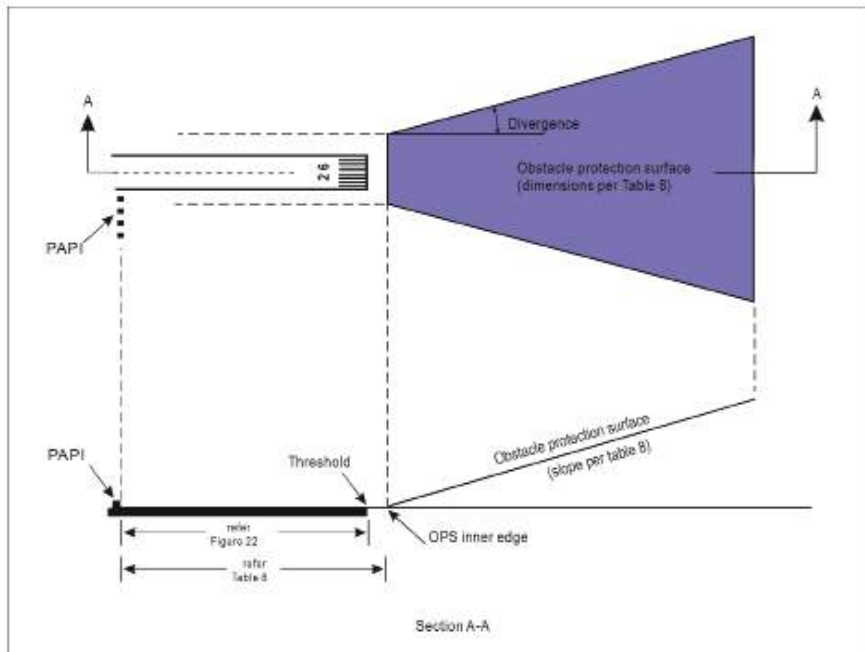
**Table 8 Dimensions and slopes of the obstacle protection surface**

	Runway type/code number							
	Non-instrument Code number				Instrument Code number			
Surface dimensions	1	2	3	4	1	2	3	4
Length of inner edge	60 m	80 m <sup>a</sup>	150 m	150 m	150 m	150 m	300 m	300 m
Distance from the visual approach slope indicator system <sup>b</sup>	D <sub>1</sub> +30 m	D <sub>1</sub> +60 m	D <sub>1</sub> +60 m	D <sub>1</sub> +60 m	D <sub>1</sub> +60 m	D <sub>1</sub> +60 m	D <sub>1</sub> +60 m	D <sub>1</sub> +60 m
Divergence (each side)	10%	10%	10%	10%	15%	15%	15%	15%
Total length	7 500 m	7 500 m	15 000 m	15 000 m	7 500 m	7 500 m	15 000 m	15 000m
<i>Slope</i>								
(b) PAPI <sup>a</sup>	–	A–0.57°	A–0.57°	A–0.57°	A–0.57°	A–0.57°	A–0.57°	A–0.57°
(c) APAPI <sup>a</sup>	A–0.9°	A–0.9°	–	–	A–0.9°	A–0.9°	–	–

<sup>a</sup> Angles as indicated in Figure 20.

<sup>b</sup> D1 is the distance of the visual approach slope indicator system from threshold prior to any displacement to remedy object penetration of the OPS (refer Figure 19). The start of the OPS is fixed to the visual approach slope indicator system location, such that displacement of the PAPI results in an equal displacement of the start of the OPS. See subregulation (5) (e).

**Figure 24 OPS for visual approach slope indicator systems**



(3) New objects or extensions of existing objects shall not be permitted above the OPS except where, in the opinion of the authority, the new object or extension would be shielded by an existing immovable object.

(4) Existing objects above the OPS shall be removed except where, in the opinion of the authority, the object is shielded by an existing immovable object, or after aeronautical study it is established that the object would not adversely affect the safety of operations of aeroplanes.

(5) Where an aeronautical study indicates that an existing object extending above the OPS could adversely affect the safety of operations of aeroplanes one or more of the following measures shall be taken—

- (a) remove the object;

- (b) suitably raise the approach slope of the system;
- (c) reduce the azimuth spread of the system so that the object is outside the confines of the beam;
- (d) displace the axis of the system and its associated OPS by no more than 5°; or
- (e) suitably displace the system upwind of the threshold such that the object no longer penetrates the obstacle protection surface.

## **172. Circling guidance lights**

(1) Circling guidance lights shall be provided where the existing approach and runway lighting systems do not satisfactorily permit identification of the runway or approach area to a circling aircraft in the conditions for which the runway is intended be used for circling approaches.

(2) The location and number of the circling guidance lights referred to in subregulation (1) shall be adequate to enable a pilot, to —

- (a) join the downwind leg or align and adjust the aircraft's track to the runway at a required distance from it and to distinguish the threshold in passing; and
  - (b) keep in sight the runway threshold and other features which will make it possible to judge the turn on to base leg and final approach, taking into account the guidance provided by other visual aids.
- (3) The circling guidance lights shall consist of—
- (a) lights indicating the extended center line of the runway or parts of any approach lighting system;
  - (b) lights indicating the position of the runway threshold; and
  - (c) lights indicating the direction or location of the runway;

or a combination of such lights as is appropriate to the runway under consideration.



(4) Circling guidance lights shall be fixed or flashing lights of an intensity and beam spread adequately for the conditions of visibility and ambient light intended to make visual circling approaches.

(5) The flashing lights shall be white and the steady lights either white or gaseous discharge lights.

(6) The lights shall be designed and installed in such a manner that they will not dazzle or confuse a pilot when approaching to land, taking off or taxiing.

### **173. Runway threshold identification lights**

(1) Runway threshold identification lights shall be installed—

- (a) at the threshold of a non-precision approach runway when additional threshold conspicuity is necessary or where it is not practicable to provide other approach lighting aids; and
- (b) where a runway threshold is permanently displaced from the runway extremity or temporarily displaced from the normal position and additional threshold conspicuity is necessary.

(2) Runway threshold identification lights shall be located symmetrically about the runway center line, in line with the threshold and approximately 10m outside each line of runway edge lights.

(3) Runway threshold identification lights shall be flashing white lights with a flash frequency range of 60 to 120 flashes per minute.

(4) The lights shall be visible only in the direction of approach to the runway.

#### **174. Runway lead-in lighting systems**

(1) A runway lead-in lighting system shall be provided where it is desired to provide visual guidance along a specific approach path, to avoid hazardous terrain or for noise abatement.

(2) A runway lead-in lighting system shall consist of groups of lights positioned to define the desired approach path and to enable one group to be sighted from the preceding group.

(3) The interval between adjacent groups shall not exceed 1600m.

(4) A runway lead-in lighting system shall extend from a point determined by the aerodrome operator, up to a point where the approach lighting system if provided, or the runway lighting system is in view.

(5) Each group of lights of a runway lead-in lighting system shall consist of not less than three flashing lights in a linear or cluster configuration.

(6) The system may be augmented by steady burning lights where such lights assist in identifying the system.

(7) The flashing and steady burning lights shall be white.

(8) Where practicable, the flashing lights in each group shall flash in sequence towards the runway.

#### **175. Runway edge lights**

(1) Runway edge lights shall be provided for a runway intended for use at night or for a precision approach runway intended for use by day or night.

(2) Runway edge lights shall be provided on a runway intended for take-off with an operating minimum below an RVR of the order of 800m by day.

(3) Runway edge lights shall be placed along the full length of the runway and shall be in two parallel rows equidistant from the center line.

(4) Runway edge lights shall be placed along the edges of the area declared for use as the runway or outside the edges of the area at a distance of not more than 3m.

(5) Where the width of the area declared as a runway exceeds 60m, the distance between the rows of lights shall be determined taking into account the nature of the operations, the light distribution characteristics of the runway edge lights and other visual aids serving the runway.

(6) The lights shall be uniformly spaced in rows at intervals of not more than 60m for an instrument runway and at intervals of not more than 100m for a non-instrument runway.

(7) The lights on opposite sides of the runway axis shall be on lines at right angles to that axis.

(8) At intersections of runways, lights may be spaced irregularly or omitted, provided that adequate guidance remains available to the pilot.

(9) The runway edge lights shall be fixed lights showing variable white, except that—

- (a) in the case of a displaced threshold, the lights between the beginning of the runway and the displaced threshold shall show red in the approach direction; and
- (b) a section of the lights 600m or one-third of the runway length, whichever is the less, at the remote end of the runway from the end at which the take-off run is started, may show yellow.

(10) The runway edge lights shall show at all angles in azimuth necessary to provide guidance to a pilot landing or taking off in either direction and where the runway edge lights are intended to provide circling guidance, they shall show at all angles in azimuth.

(11) In all angles of azimuth referred to in subregulation (10), the runway edge lights shall show at all angles up to 15° above the horizontal with an intensity adequate for the conditions of visibility and ambient light in which use of the runway for take-off or landing is intended.

(12) The intensity of the runway edge lights shall not be less than 50cd except that at an aerodrome without extraneous lighting, the intensity of the lights may be reduced to not less than 25cd to avoid dazzling the pilot.

(13) The runway edge lights on a precision approach runway shall conform to the specifications set out in Figure S4-9 and Figure S4-10 in Schedule 4 to these Regulations.

### **176. Runway threshold and wing bar lights**

(1) Runway threshold lights shall be provided for a runway equipped with runway edge lights except for a non-instrument or non-precision approach runway where the threshold is displaced and wing bar lights are provided, as set out in figure 25.

(2) Where a threshold is at the extreme end of a runway, the threshold lights shall be placed in a row at right angles to the runway axis as near to the extreme end of the runway as possible and, in any case, not more than 3m outside the extreme end.

(3) Where a threshold is displaced from the extreme end of a runway, the threshold lights shall be placed in a row at right angles to the runway axis at the displaced threshold.

(4) Threshold lighting shall consist of—

- (a) not less than six lights on a non-instrument or non-precision approach runway;
  - (b) not less than the number of lights that would be required if the lights were uniformly spaced at intervals of 3m between the rows of runway edge lights, on a precision approach runway category I; and
  - (c) lights uniformly spaced between the rows of runway edge lights at intervals of not more than 3m on a precision approach runway category II or III.
- (5) The lights prescribed in subregulations(4) (a) and (b) shall be either—
- (a) equally spaced between the rows of runway edge lights; or
  - (b) symmetrically disposed about the runway center line in two groups, with the lights uniformly spaced in each group and with a gap between the groups equal to the gauge of the touchdown zone marking or lighting, where such is provided, or otherwise not more than half the distance between the rows of runway edge lights.
- (6) Wing bar lights shall be provided on a precision approach runway where additional conspicuity is considered desirable.
- (7) Wing bar lights shall be provided on a non-instrument or non-precision approach runway where the threshold is displaced and runway threshold lights are required, but are not provided.
- (8) Wing bar lights shall be symmetrically disposed about the runway center line at the threshold in two groups,.
- (9) Each wing bar shall be formed by not less than five lights extending not less than 10m outward from, and at right angles to, the line of the runway edge lights, with the innermost light of each wing bar in the line of the runway edge lights.

# Figure 25: Arrangement of runway threshold and runway end lights

CONDITION	NON-INTRUMENT AND/OR PRECISION APPROACH RUNWAYS	PRECISION CATEGORY I RUNWAYS	RUNWAY TYPE	PRECISION CATEGORY II RUNWAYS	PRECISION CATEGORY III RUNWAYS
RUNWAY THRESHOLD AND RUNWAY END LIGHTS	<p>§3.10.2.3.114 (a), §3.10.2.3.114 (b), §3.11.2.3.311 (a), §3.11.2.3.311 (b)</p>	<p>§3.10.2.3.114 (a), §3.10.2.3.114 (b), §3.11.2.3.311 (a), §3.11.2.3.311 (b)</p>	<p>§3.10.2.3.114 (a), §3.10.2.3.114 (b), §3.11.2.3.311 (a), §3.11.2.3.311 (b)</p>	<p>§3.10.2.3.114 (a), §3.10.2.3.114 (b), §3.11.2.3.311 (a), §3.11.2.3.311 (b)</p>	<p>§3.10.2.3.114 (a), §3.10.2.3.114 (b), §3.11.2.3.311 (a), §3.11.2.3.311 (b)</p>
DISPLACED THRESHOLD RUNWAY THRESHOLD AND RUNWAY END LIGHTS	<p>§3.10.2.3.114 (a), §3.10.2.3.114 (b), §3.11.2.3.311 (a), §3.11.2.3.311 (b)</p>	<p>§3.10.2.3.114 (a), §3.10.2.3.114 (b), §3.11.2.3.311 (a), §3.11.2.3.311 (b)</p>	<p>§3.10.2.3.114 (a), §3.10.2.3.114 (b), §3.11.2.3.311 (a), §3.11.2.3.311 (b)</p>	<p>§3.10.2.3.114 (a), §3.10.2.3.114 (b), §3.11.2.3.311 (a), §3.11.2.3.311 (b)</p>	<p>§3.10.2.3.114 (a), §3.10.2.3.114 (b), §3.11.2.3.311 (a), §3.11.2.3.311 (b)</p>
RUNWAY LIGHTS	<p>§3.10.2.3.114 (a), §3.10.2.3.114 (b), §3.11.2.3.311 (a), §3.11.2.3.311 (b)</p>	<p>§3.10.2.3.114 (a), §3.10.2.3.114 (b), §3.11.2.3.311 (a), §3.11.2.3.311 (b)</p>	<p>§3.10.2.3.114 (a), §3.10.2.3.114 (b), §3.11.2.3.311 (a), §3.11.2.3.311 (b)</p>	<p>§3.10.2.3.114 (a), §3.10.2.3.114 (b), §3.11.2.3.311 (a), §3.11.2.3.311 (b)</p>	<p>§3.10.2.3.114 (a), §3.10.2.3.114 (b), §3.11.2.3.311 (a), §3.11.2.3.311 (b)</p>

LEGEND  
 UNIDIRECTIONAL LIGHT  
 BIDIRECTIONAL LIGHT  
 CONDITIONAL COMBINATION

Note — The minimum number of lights are shown for a runway of its width with runway edge lights installed at the edge.

Figure 5-21. Arrangement of runway threshold and runway end lights

(10) Runway threshold and wing bar lights shall be fixed unidirectional lights showing green in the direction of approach to the runway.

(11) The intensity and beam spread of the lights shall be adequate for the conditions of visibility and ambient light for which use of the runway is intended.

(12) Runway threshold lights on a precision approach runway shall conform to the specifications in Figure S4 – 3 in Schedule 4 to these Regulations.

(13) Threshold wing bar lights on a precision approach runway shall conform to the specifications in Figure S4 – 4 in Schedule 4, to these Regulations.

**177. Runway end lights**

(1) The runway end lights shall be provided for a runway equipped with runway edge lights.

(2) The runway end lights shall be placed on a line at right angles to the runway axis as near to the end of the runway as possible and, in any case, not more than 3m outside the end.

(3) The runway end lighting shall consist of not less than six lights and the lights shall be either—

- (a) equally spaced between the rows of the runway edge lights; or
- (b) symmetrically disposed about the runway center line in two groups, with the lights uniformly spaced in each group and with a gap between the groups of not more than half the distance between the rows of the runway edge lights.

(4) In the case of a precision approach runway Category III, the spacing between runway end lights, shall not exceed 6m except between the two innermost lights if a gap is used.

(5) The runway end lights shall be fixed unidirectional lights showing red in the direction of the runway.

(6) The intensity and beam spread of the lights shall be adequate for the conditions of visibility and ambient light for which use of the runway is intended.

(7) The runway end lights on a precision approach runway shall conform to the specifications set out in Figure S4-8 in Schedule 4 to these Regulations.

### **178. Runway center line lights**

(1) Runway center line lights shall be provided on a precision approach runway Category II or III.

(2) Runway center line lights shall be provided on a precision approach runway Category I, particularly where the runway is used by aircraft with high landing speed or where the width between the runway edge lights is greater than 50m.

(3) Runway center line lights shall be provided on a runway intended to be used for take-off with an operating minimum below an RVR of the order of 400m.

(4) Runway center line lights shall be provided on a runway intended to be used for take-off with an operating minimum of an RVR of the order of 400m or higher when used by aeroplanes with a very high take-off speed, particularly where the width between the runway edge lights is greater than 50m.

(5) Runway center line lights shall be located along the center line of the runway, except that the lights may be uniformly offset to the same side of the runway center line by not more than 60cm.

(6) Where it is not practicable to locate the runway center lights along center line, the lights shall be located from the threshold to the end; and at a longitudinal spacing of approximately 15m.

(7) Where the serviceability level of the runway center line lights specified as maintenance objectives in Regulation 281 (9) or (17)



and the runway is intended for use in runway visual range conditions of 350m or greater, the longitudinal spacing may be approximately 30m.

(8) The center line guidance for take-off from the beginning of a runway to a displaced threshold shall be provided by—

- (a) an approach lighting system if its characteristics and intensity settings afford the guidance required during take-off and does not dazzle the pilot of an aircraft taking off;
- (b) runway center line lights; or
- (c) barrettes of not less than 3m length and spaced at uniform intervals of 30m, as set out in Figure 26, and shall be designed so that their photometric characteristics and intensity setting afford the guidance required during take-off without dazzling the pilot of an aircraft that is taking off.

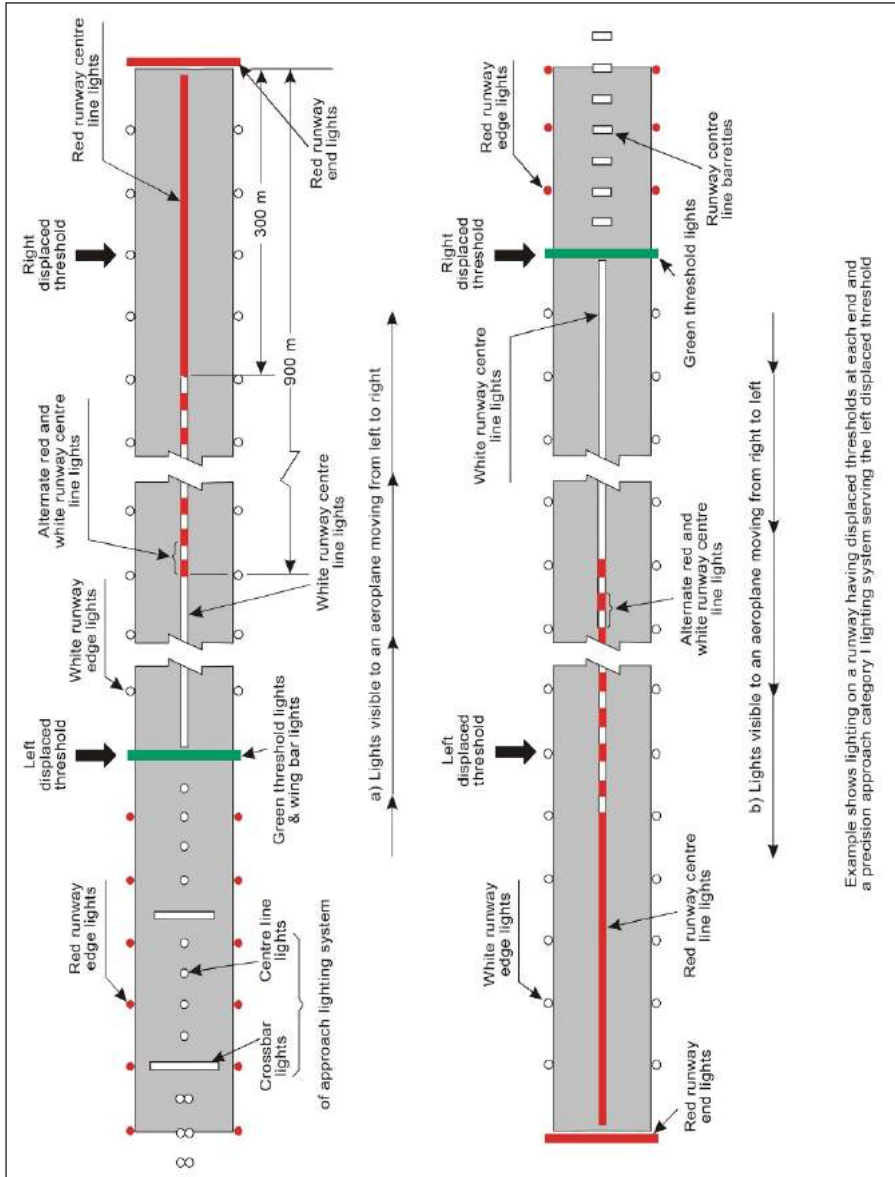
(9) Where necessary, provision shall be made to extinguish the center line lights specified in subregulation (8) (b) or reset the intensity of the approach lighting system or barrettes when the runway is being used for landing.

(10) In no case shall only the single source runway center line lights show from the beginning of the runway to a displaced threshold when the runway is being used for landing.

(11) Runway center line lights shall be fixed lights showing variable white from the threshold to the point 900m from the runway end; alternate red and variable white from 900m to 300m from the runway end; and red from 300m to the runway end, except that for runways less than 1,800m in length, the alternate red and variable white lights shall extend from the mid-point of the runway usable for landing to 300m from the runway end.

(12) Runway center line lights shall conform to the specifications in Figure S4-6 or S4-7 of Schedule 4 to these Regulations.

**Figure 26: Example of approach and runway lighting for runway with displaced thresholds**



Example shows lighting on a runway having displaced thresholds at each end and a precision approach category I lighting system serving the left displaced threshold

### **179. Runway touchdown zone lights**

(1) Touchdown zone lights shall be provided in the touchdown zone of a precision approach runway category II or III.

(2) Touchdown zone lights shall extend from the threshold for a longitudinal distance of 900m, except that, in the case of runways with less than 1,800m in length, the system shall be shortened so that it does not extend beyond the midpoint of the runway.

(3) A pattern shall be formed by pairs of barrettes symmetrically located about the runway center line.

(4) The lateral spacing between the innermost lights of a pair of barrettes shall be equal to the lateral spacing selected for the touchdown zone marking.

(5) The longitudinal spacing between pairs of barrettes shall be either 30m or 60m.

(6) A barrette shall be composed of not less than three lights with a spacing between the lights of not more than 1.5m.

(7) A barrette shall not be less than 3m and not more than 4.5m in length.

(8) Touchdown zone lights shall be fixed unidirectional lights showing variable white.

(9) The specifications of the touchdown zone lights shall be as set out in Figure S4-5 of Schedule 4 to these Regulations.

### **180. Simple Touchdown Zone lights**

(1) Except where Touchdown Zone (TDZ) lights are provided, in accordance with regulation 179, at an aerodrome where the approach

angle is greater than 3.5 degrees or the Landing Distance Available (LDA) combined with other factors increases the risk of an overrun, simple TDZ lights shall be provided.

(2) Simple TDZ lights shall be a pair of lights located on each side of the runway center line 0.3 meters beyond the upwind edge of the final TDZ marking.

(3) The lateral spacing between the inner lights of the two pairs of lights shall be equal to the lateral spacing selected for the TDZ marking.

(4) The spacing between the lights of the same pair shall not be more than 1.5m or half the width of the TDZ marking, whichever is greater, as set out in figure 27.

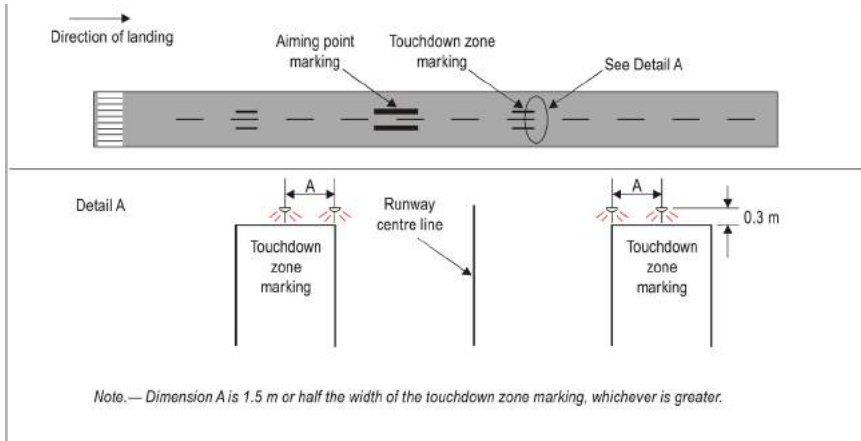
(5) Where provided on a runway without TDZ markings, simple TDZ lights shall be installed in a position that provides the equivalent TDZ information.

(6) Simple TDZ lights shall be fixed unidirectional lights showing variable white, aligned so as to be visible to the pilot of a landing aeroplane in the direction of approach to the runway.

(7) Simple TDZ lights shall conform to the specifications set out in Figure S4–5 in Schedule 4 to these Regulations.

(8) Simple TDZ lights shall be supplied with power on a separate circuit to other runway lighting so that they may be used when other lighting is switched off.

**Figure 27: Simple touchdown zone lighting**

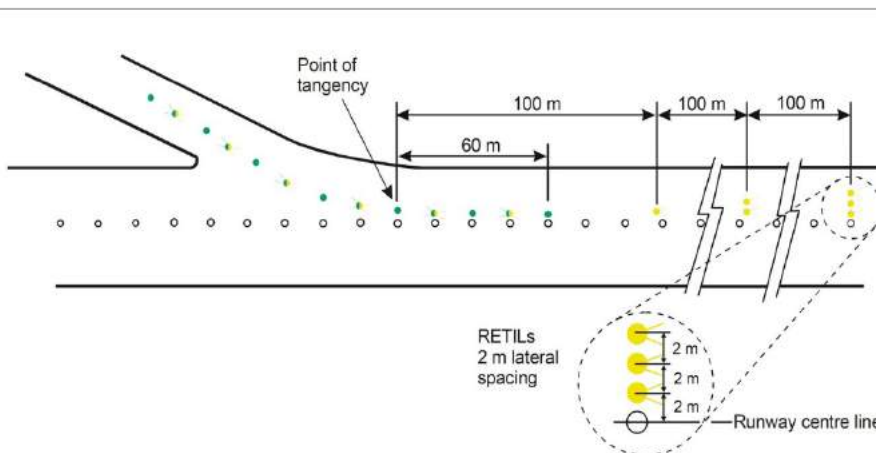


**181. Rapid exit taxiway indicator lights**

(1) Rapid exit taxiway indicator lights shall be provided on a runway intended for use in runway visual range condition less than value of 350m or where the traffic density is heavy.

(2) Rapid exit taxiway indicator lights shall not be displayed in the event of any lamp failure or other failure that prevents the display of the light pattern depicted in Figure 28, in full.

**Figure 28. Rapid exit taxiway indicator lights (RETILS)**



(3) A set of rapid exit taxiway indicator lights shall be located on the runway on the same side of the runway center line as the associated rapid exit taxiway, in the configuration set out in Figure 28, and in each set, the light shall be located 2m apart and light nearest to the runway center line shall be displaced 2 m from the runway center line.

(4) Where more than one rapid exit taxiway exits on a runway, the set of rapid exit taxiway indicator light for each exit shall not overlap when displayed.

(5) Rapid exit taxiway indicator lights shall be fixed unidirectional yellow lights, aligned in order to be visible to the pilot of a landing aeroplane in the direction of the approach to the runway.

(6) Rapid exit taxiway indicator lights shall where appropriate, conform to the specifications in Figure S4 – 6 and S4 - 7 of Schedule 4 to these Regulations.

(7) The rapid exit taxiway indicator lights shall be supplied with power on a separate circuit to other runway lights so that they may be used when the other lighting is switched off.

## **182. Stopway lights**

(1) Stopway lights shall be provided for a stopway intended for use at night.

(2) Stopway lights shall be placed along the full length of the stopway and shall be in two parallel rows that are equidistant from the center line and coincident with the rows of the runway edge lights.

(3) Stopway lights shall be provided across the end of a stopway on a line at right angles to the stopway axis as near to the end of the stopway as possible and, in any case, not more than 3m outside the end.

(4) Stopway lights shall be fixed unidirectional lights showing red in the direction of the runway.

### **183. Taxiway center line lights**

(1) Taxiway center line lights shall be provided on an exit taxiway, taxiway and apron intended for use in runway visual range conditions less than a value of 350m in such a manner as to provide continuous guidance between the runway center line and aircraft stands, except that the lights need not be provided where the traffic density is light and taxiway edge lights and center line marking provide adequate guidance.

(2) Taxiway center line lights shall be provided on a taxiway intended for use at night in runway visual range conditions of 350m or greater and particularly on complex taxiway intersections and exit taxiways, except that the lights need not be provided where the traffic density is light and taxiway edge lights and center line marking provide adequate guidance.

(3) Taxiway center line lights shall be provided on an exit taxiway, taxiway and apron in all visibility conditions where specified as components of an advanced surface movement guidance and control system in such a manner as to provide continuous guidance between the runway center line and aircraft stands.

(4) Taxiway center line lights shall be provided on a runway forming part of a standard taxi-route and intended for taxiing in runway visual range conditions less than a value of 350m, except that the lights need not be provided where the traffic density is light and taxiway edge lights and center line marking provide adequate guidance.

(5) Taxiway center line lights shall be provided in all visibility conditions on a runway forming part of a standard taxi route where specified as components of an advanced surface movement guidance and control system.

(6) Except as provided in subregulation (10), taxiway center line lights on a taxiway other than an exit taxiway and on a runway forming part of a standard taxi-route shall be fixed lights showing green with beam dimensions such that the light is visible only from aeroplanes on or in the vicinity of the taxiway.

(7) Taxiway center line lights on an exit taxiway shall be fixed lights.

(8) Alternate taxiway center line lights on an exit taxiway shall show green and yellow from beginning near the runway center line to the perimeter of the ILS critical area or the lower edge of the inner transitional surface, whichever is farthest from the runway; and thereafter all lights shall show green, as set out in figure 29.

(9) The first light in the exit center line shall always show green and the light nearest to the perimeter shall always show yellow.

(10) Where it is necessary to denote the proximity to a runway, taxiway center line lights shall be fixed lights showing alternating green and yellow from the perimeter of the ILS critical area or the lower edge of the inner transitional surface, whichever is farthest from the runway, to the runway and continue alternating green and yellow until—

- (a) their end point near the runway center line; or
- (b) in the case of the taxiway center line lights crossing the runway, to the opposite perimeter of the ILS critical area or the lower edge of the inner transitional surface, whichever is farthest from the runway.

(11) Where higher intensities are required, from an operational point of view, taxiway center line lights on rapid exit taxiways intended for use in runway visual range conditions less than a value of 350m shall conform to the specifications set out in Figure S4-12 of Schedule 4 to these Regulations.



(12) The number of levels of brilliancy settings for the lights shall be the same as that for the runway center line lights.

(13) Where taxiway center line lights are specified as components of an advanced surface movement guidance and control system and where, from an operational point of view, higher intensities are required to maintain ground movements at a certain speed in very low visibilities or in bright day time conditions, taxiway center line lights shall conform to the specifications prescribed by the authority in Figures S4-17, S4-18 or S4-19 of Schedule 4 to these Regulations.

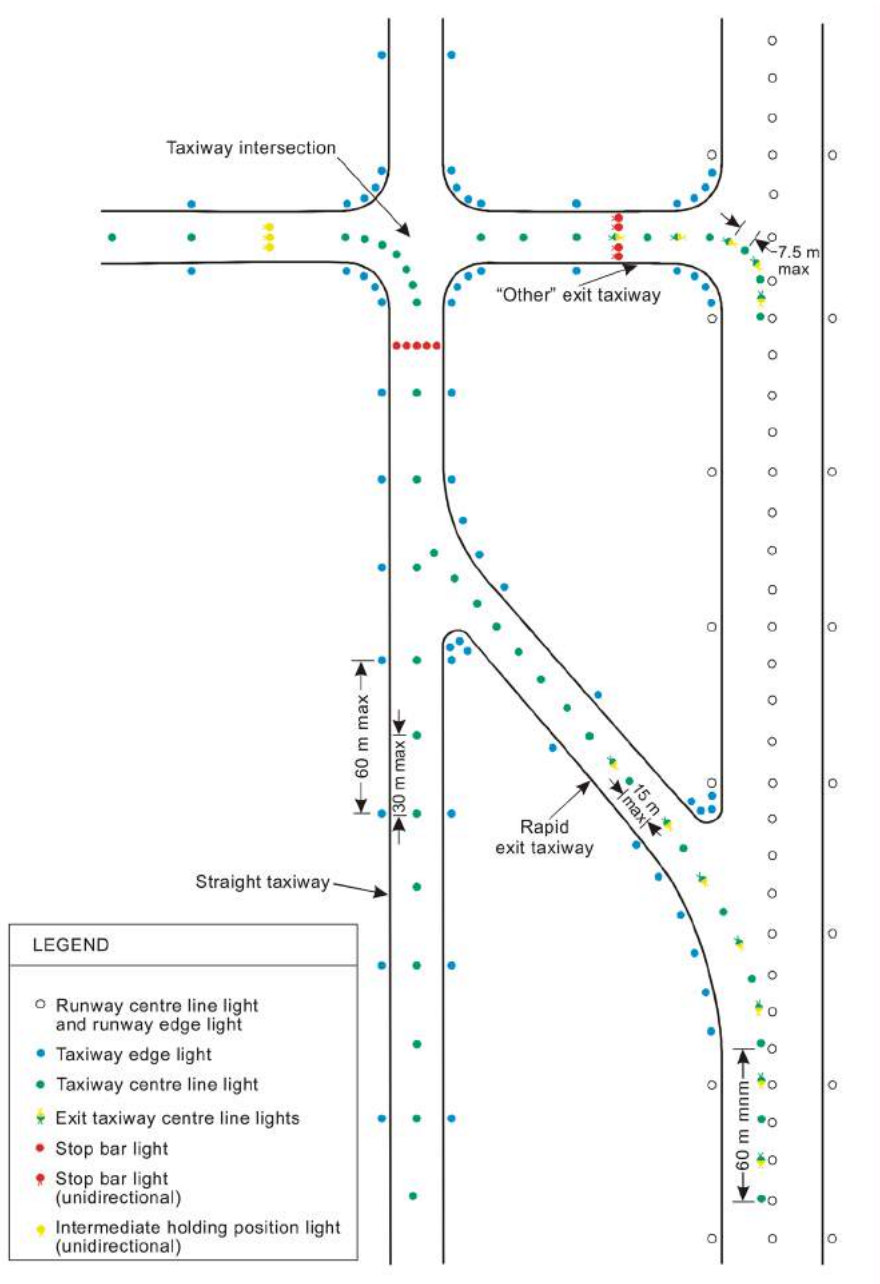
(14) High-intensity center line lights shall only be used in case of an absolute necessity and following a specific study.

(15) Taxiway center line lights shall normally be located on the taxiway center line marking, except that they may be offset by not more than 30cm where it is not practicable to locate them on the marking.

(16) Taxiway center line lights shall conform to the following specifications set out in—

- (a) Figure S4-12, S4-13 or S4 – 14 in Schedule 4 to these Regulations in respect of taxiways intended for use in runway visual range conditions of less than a value of 350m; and
- (b) Figure S4-15 or S4-16 in Schedule 4 to these Regulations in respect of other taxiways.

**Figure 29: Taxiway lighting**



### **184. Taxiway center line lights on taxiways**

(1) Taxiway center line lights on a straight section of a taxiway shall be spaced at longitudinal intervals of not more than 30m, except that—

- (a) larger intervals not exceeding 60m may be used where, because of the prevailing meteorological conditions, adequate guidance is provided by such spacing;
- (b) intervals less than 30m shall be provided on short straight sections; and
- (c) the longitudinal spacing shall not exceed 15m in the case of a taxiway intended for use in RVR conditions of less than a value of 350m.

(2) Taxiway center line lights on a taxiway curve shall continue from the straight portion of the taxiway at a constant distance from the outside edge of the taxiway curve and the lights shall be spaced at intervals such that a clear indication of the curve is provided.

(3) On a taxiway intended for use in RVR conditions of less than a value of 350m, the lights on a curve shall not exceed a spacing of 15 m and on a curve of less than 400m radius the lights shall be spaced at intervals of not more than 7.5m and this spacing shall extend for 60 m before and after the curve set out in the table below—

<b>Curve radius</b>	<b>Light spacing</b>
Up to 400m	7.5m
401m to 899m	15m
900m or greater	30m

### **185. Taxiway center line lights on rapid exit taxiways**

(1) Taxiway center line lights on rapid exit taxiway shall commence at a point at least 60m before the beginning of the taxiway center line curve and shall continue beyond the curve, to a point on the

taxiway to a point on the center line of the taxiway where an aeroplane can be expected to reach normal taxiing speed.

(2) Subject to subregulation (1) the lights on that portion parallel to the runway center line shall not be less than 60m from any row of runway center line lights as set out in Figure 30.

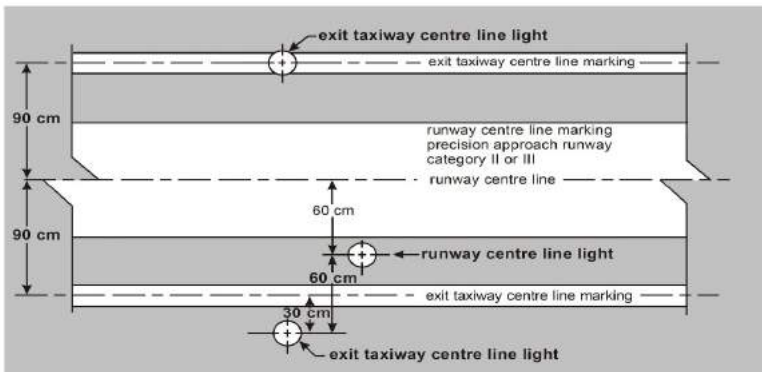
(3) Taxiway center line lights on rapid exit taxiway shall be spaced at longitudinal intervals of not more than 15m, except that where runway center line lights are not provided with a greater interval not exceeding 30m may be used.

### 186. Taxiway center line lights on other exit taxiways

(1) Taxiway center line lights on exit taxiways other than other rapid exit taxiways shall commence at the point where the taxiway center line marking begins to curve from the runway center line, and follow the curved taxiway center line marking at least to the point where the marking leaves the runway and the first light shall not be less than 60cm from any row of runway center line lights, as set out in Figure 30.

(2) The lights shall be spaced at longitudinal intervals of not more than 7.5m.

**Figure 30. Offset runway and taxiway center line lights**



Tolerances for offset runway centre line lights and taxiway centre line lights to maintain 60 cm separation.

### **187. Taxiway center line lights on runways**

Taxiway center line lights on a runway forming part of a standard taxi-route and intended for taxiing in runway visual range conditions of less than a value of 350m, shall be spaced at longitudinal intervals not exceeding 15m.

### **188. Taxiway edge lights**

(1) Taxiway edge lights shall be provided at the edges of a holding bay apron and runway turn pad intended for use at night and on a taxiway not provided with taxiway center line lights and intended for use at night, except that taxiway edge lights need not be provided where, considering the nature of the operations, adequate guidance can be achieved by surface illumination or other means.

(2) Taxiway edge lights shall be provided on a runway forming part of a standard taxi-route and intended for taxiing at night where the runway is not provided with taxiway center line lights.

(3) Taxiway edge lights on a straight section of a taxiway and on a runway forming part of a standard taxi-route shall be spaced at uniform longitudinal intervals of not more than 60m.

(4) The lights on a curve shall be spaced at intervals less than 60m so that a clear indication of the curve is provided.

(5) Taxiway edge lights on a holding bay, apron, shall be spaced at uniform longitudinal intervals of not more than 60m, avoiding a sea blue effect from Aeronautical Decision Making.

(6) Taxiway edge lights on a runway turn pad shall be spaced at uniform longitudinal interval of not more than 30m.

(7) The lights shall be located as near as practicable to the edges of the taxiway, runway turn pad, holding bay, apron or runway, or outside the edges at a distance of not more than 3m.

(8) Taxiway edge lights shall be fixed lights showing blue.

(9) The lights shall show up to not less than  $75^\circ$  above the horizontal and at all angles in azimuth necessary to provide guidance to a pilot taxiing in either direction.

(10) At an intersection, exit or curve, the lights shall be shielded as far as practicable so that they cannot be seen in angles of azimuth in which they may be confused with other lights.

(11) The intensity of taxiway edge lights shall not be less than 2 cd from  $0^\circ$  to  $6^\circ$  vertical, and 0.2cd at any vertical angles between  $6^\circ$  and  $75^\circ$ .

### **189. Runway turn pad lights**

(1) Runway turn pad lights shall be provided for continuous guidance on a runway turn pad intended for use in runway visual range conditions of less than a value of 350m, for the purpose of enabling an aeroplane complete a 180-degree turn and align with the runway center line.

(2) Runway turn pad lights shall be provided on a runway turn pad intended for use at night.

(3) Runway turn pad lights shall normally be located on the runway turn pad marking, except that they may be offset by not more than 30cm where it is not practicable to locate them on the marking.

(4) Runway turn pad lights on a straight section of the runway turn pad marking shall be spaced at longitudinal intervals of not more than 15m.

(5) Runway turn pad lights on a curved section of the runway turn pad marking shall not exceed a spacing of 7.5m.

(6) Runway turn pad lights shall be unidirectional fixed lights showing green with beam dimensions such that the light is visible only from aeroplanes on or approaching the runway turn pad.

(7) Runway turn pad lights shall be in accordance with the specifications in Figure S4 – 13 to S4 – 14 or S4– 15 as set out in Schedule 4 to these Regulations.

### **190. Stop bars**

(1) A stop bar shall be controlled either manually or automatically by air traffic services.

(2) A stop bar shall be provided at every runway holding position serving a runway when it is intended that the runway will be used in runway visual range conditions of less than a value of 550m, except where—

- (a) appropriate aids and procedures are available to assist in preventing inadvertent incursions of traffic onto the runway; or
- (b) operational procedures exist to limit, in runway visual range conditions of less than a value of 550m, the number of—
  - (i) aircraft on the manoeuvring area to one at a time; and
  - (ii) vehicles on the manoeuvring area to the essential minimum.

(3) Where there is more than one stop bar associated with a taxiway or runway intersection, only one stop bar shall be illuminated at any given time.

(4) A stop bar shall be provided at an intermediate holding position where it is desired to supplement markings with lights and to provide traffic control by visual means.

(5) Stop bars shall be located across the taxiway at the point where it is desired that traffic stop.

(6) Where the additional lights specified in subregulation (8) are provided, these lights shall be located not less than 3m from the taxiway edge.

(7) Stop bars shall consist of lights spaced at uniform intervals of not more than 3m across the taxiway, showing red in the intended direction of approach to the intersection or runway-holding position.

(8) A pair of elevated lights shall be added to each end of the stop bar where the in-pavement stop bar lights might be obscured from a pilot's view, or where a pilot may be required to stop the aircraft in a position so close to the lights that they are blocked from view by the structure of the aircraft.

(9) Stop bars installed at a runway-holding position shall be unidirectional and shall show red in the direction of approach to the runway.

(10) Where the additional lights specified by the authority are provided, the lights shall have the same characteristics as the lights in the stop bar, but shall be visible to approaching aircraft up to the stop bar position.

(11) Stop bar lights shall be operated for all aircraft and vehicles that require to cross a runway holding position so equipped.

(12) Where stop bars are specified as components of an advanced surface movement guidance and control system and where, from an operational point of view, higher intensities are required to maintain ground movements at a certain speed in very low visibilities or in bright daytime conditions, the intensity in red light and beam spreads of stop bar lights shall be in accordance with the specifications in Figures S4 – 17, S4 – 18 or S4 - 19 of Schedule 4 to these Regulations.

(13) The lighting circuit shall be designed so that—

(a) stop bars located across entrance taxiways are selectively switchable;



- (b) stop bars located across taxiways intended to be used only as exit taxiways are switchable selectively or in groups;
- (c) when a stop bar is illuminated, any taxiway center line lights installed beyond the stop bar shall be extinguished for a distance of at least 90m; and
- (d) stop bars are interlocked with the taxiway center line lights so that when the center line lights beyond the stop bar are illuminated the stop bar is extinguished and vice versa.

(14) The intensity in red light and beam spreads of stop bar lights shall be in accordance with the specifications set out in Figures S4 – 12 to S4 – 16 of Schedule 4 to these Regulations.

(15) Where a wide beam fixture is required, the intensity in red light and beam spreads of stop bar lights shall be in accordance with the specifications set out in Figure S4 – 17 or S4 – 19 of Schedule 4 to these Regulations.

### **191. No entry bar**

(1) A no-entry bar shall be provided across the taxiway which is intended to be used as an exit only taxiway for the purpose of assisting in preventing inadvertent access of traffic to that taxiway.

(2) A no-entry bar shall be located across the taxiway or at the end of an exit only taxiway for purposes of preventing traffic from entering the taxiway from the wrong direction.

(3) A no-entry bar shall be co-located with a no-entry sign or a no-entry marking.

(4) A no-entry bar shall consist of unidirectional lights spaced at uniform intervals of no more than 3m showing red in the intended direction of approach to the runway and where necessary, to enhance conspicuity, extra lights shall be installed uniformly.

(5) A pair of elevated lights shall be added to each end of the no-entry bar where the in-pavement no-entry bar lights might be

obscured from the pilot's view or where the a pilot may be required to stop the aircraft in a position so close to the lights that they are blocked from view by the structure of the aircraft.

(6) The intensity in red light and beam spreads of no-entry bar lights shall be in accordance with the specifications set out in Figure S4 – 12 to S4 – 16 of Schedule 4 to these Regulations.

(7) Where no-entry bars are specified as components of an advanced surface movement guidance and control system and where, from an operational point of view, higher intensities are required to maintain ground movements at a certain speed in very low visibilities or in bright daytime conditions, the intensity in red light and beam spreads of no-entry bar lights shall be in accordance with the specifications set out in Figure S4 – 7, S4 – 18 or S4 – 19 of Schedule 4 to these Regulations.

(8) Where a wide beam fixture is required, the intensity in red light and beam spreads of no-entry bar lights shall be in accordance with the specifications set out in Figure S4 – 17 or S4 – 19 of Schedule 4 to these Regulations.

(9) Taxiway center line lights installed beyond the no-entry bar, facing in the direction of the runway, shall not be visible when viewed from the taxiway.

## **192. Intermediate holding position lights**

(1) Except where a stop bar has been installed, intermediate holding position lights shall be provided at an intermediate holding position intended for use in runway visual range conditions less than a value of 350m.

(2) Intermediate holding position lights shall be provided at an intermediate holding position where there is no need for stop-and-go signals as provided by a stop bar.

(3) Intermediate holding position lights shall be located along the intermediate holding position marking at a distance of 0.3m prior to the marking.

(4) Intermediate holding position lights shall consist of three fixed unidirectional lights showing yellow in the direction of approach to the intermediate holding position with a light distribution similar to taxiway center line lights if provided.

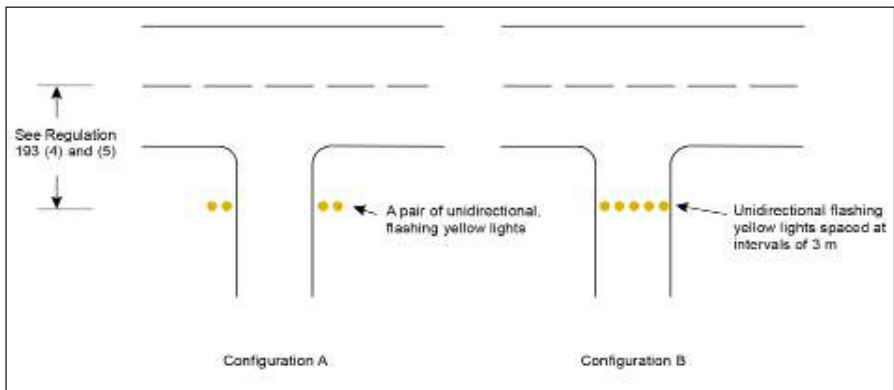
(5) The lights shall be disposed symmetrically about and at right angle to the taxiway center line, with individual lights spaced 1.5m apart.

### 193. Runway guard lights

(1) Runway guard lights, configuration A as set out in Figure 31, shall be provided at each taxiway or runway intersection associated with a runway intended for use in—

- (a) runway visual range conditions less than a value of 550m where a stop bar is not installed; and
- (b) runway visual range conditions of values between 550m and 1,200m where the traffic density is heavy.

**Figure 31. Runway guard lights**



(2) As part of runway incursion prevention measures, runway guard lights, configuration A or B, shall be provided at each taxiway or runway intersection where runway incursion hot spots have been identified and used under all weather conditions during day and night

(3) Configuration B runway guard lights shall not be collocated with a stop bar.

(4) Where more than one runway-holding positions exist at a runway/taxiway intersection, only the set of runway guard lights associated with the operational runway-holding position shall be illuminated.

(5) Runway guard lights, configuration A, shall be located at each side of the taxiway on the holding side of the runway-holding position marking.

(6) Runway guard lights, configuration B, shall be located across the taxiway on the holding side of the runway-holding position marking.

(7) Runway guard lights, configuration A, shall consist of two pairs of yellow lights.

(8) Where there is a need to enhance the contrast between the on and off state of runway guard lights, configuration A, intended for use during the day, a visor of sufficient size to prevent sunlight from entering the lens without interfering with the function of the fixture shall be located above each lamp or some other device or design, such as specially designed optics in lieu of a visor.

(9) Runway guard lights, configuration B, shall consist of yellow lights spaced at intervals of 3m across the taxiway.

(10) The light beam shall be unidirectional and shall show yellow in the direction of approach to the runway holding position.

(11) The intensity in yellow light and beam spreads of lights of configuration A shall be in accordance with the specifications set out in Figure S4-24 of Schedule 4 to these Regulations.

(12) Where runway guard lights are intended for use during the day, the intensity in yellow light and beam spreads of lights of Configuration A shall be in accordance with the specifications set out in Figure S4-25 of Schedule 4 to these Regulations.

(13) Where runway guard lights are specified as components of an advanced surface movement guidance and control system where higher light intensities are required, the intensity in yellow light and beam spreads of lights of Configuration A shall be in accordance with the specifications in Figure S4-25 of Schedule 4 to these Regulations.

(14) The intensity in yellow light and beam spreads of lights of Configuration B shall be in accordance with the specifications set out in Figure S4-12 of Schedule 4 to these Regulations.

(15) Where runway guard lights are intended for use during the day, the intensity in yellow light and beam spreads of lights of Configuration B shall be in accordance with the specifications set out in Figure S4-20 of Schedule 4 to these Regulations.

(16) Where runway guard lights are specified as components of an advanced surface movement guidance and control system where higher light intensities are required, the intensity in yellow light and beam spreads of lights of Configuration B shall be in accordance with the specifications set out in Figure S4-20 of Schedule 4 to these Regulations.

(17) Where provided, runway guard lights shall be operated whenever the runway is in use.

(18) The lights in each unit of configuration A shall be illuminated alternately.

(19) For configuration B, adjacent lights shall be alternately illuminated and alternative lights shall be illuminated in unison.

(20) The lights shall be illuminated between 30 and 60 cycles per minute and the light suppression and illumination periods shall be equal and opposite in each light.

#### **194. Apron floodlighting**

(1) Apron floodlighting shall be provided on an apron and on a designated isolated aircraft parking position intended to be used at night.

(2) Apron floodlights shall be located for the purposes of providing adequate illumination on all apron service areas, with a minimum of glare to pilots of aircraft in flight, on the ground, aerodrome and apron controllers, and personnel on the apron.

(3) The arrangement and aiming of floodlights shall be such that an aircraft stand receives light from two or more directions to minimise shadows.

(4) The spectral distribution of apron floodlights shall be such that the colours used for aircraft marking connected with routine servicing, and for surface and obstacle marking, can be correctly identified.

(5) The average illuminance shall be not less than—

(a) for aircraft stand—

(i) horizontal illuminance 20 lux with a uniformity ratio (average to minimum) of not more than 4 to 1; and

(ii) vertical illuminance 20 lux at a height of 2m above the apron in relevant directions; and

(b) other apron areas horizontal illuminance 50 percent of the average illuminance on the aircraft stands with a uniformity ratio (average to minimum) of not more than 4 to 1.

#### **195. Visual Docking Guidance System**

(1) A Visual Docking Guidance System (VDGS) shall be provided where it is intended to indicate, by a visual aid, the precise positioning of an aircraft on an aircraft stand and other alternative means including marshalling are not practicable.

(2) The system shall provide both azimuth and stopping guidance.

(3) The azimuth guidance unit and the stopping position indicator shall be adequate for use in all weather, visibility, background lighting and pavement conditions for which the system is intended both by day and night, but shall not dazzle the pilot.

(4) The azimuth guidance unit and the stopping position indicator shall be of a design such that—

- (a) a clear indication of malfunction of either or both is available to the pilot; and
- (b) they can be turned off.

(5) The azimuth guidance unit and the stopping position indicator shall be located in such a way that there is continuity of guidance between the aircraft stand markings, the aircraft stand manoeuvring guidance lights, if present and the VDGS.

(6) The accuracy of the system shall be adequate for the type of loading bridge and fixed aircraft servicing installations with which it is to be used.

(7) The VDGS shall be usable by all types of aircraft for which the aircraft stand is intended, preferably without selective operation.

(8) Where selective operation is required to prepare the VDGS for use by a particular type of aircraft, the VDGS shall provide an identification of the selected aircraft type to both the pilot and the system operator for purposes of ensuring that the system has been set properly.

## **196. Azimuth guidance unit in VDGS**

(1) The azimuth guidance unit shall be located on or close to the extension of the stand center line ahead of the aircraft such that its signals are visible from the cockpit of an aircraft throughout the

docking manoeuver and aligned for use at least by the pilot occupying the left seat.

(2) The azimuth guidance unit shall provide unambiguous left or right guidance which enables the pilot to acquire and maintain the lead-in line without over controlling.

(3) Where azimuth guidance is indicated by colour change, green shall be used to identify the center line and red for deviations from the center line.

### **197. Stopping position indicator in VDGS**

(1) The stopping position indicator shall be located in conjunction with or sufficiently close to, the azimuth guidance unit such that a pilot can observe both the azimuth and stop signals without turning the head.

(2) The stopping position indicator shall be usable at least by the pilot occupying the left seat.

(3) The stopping position information provided by the indicator for a particular aircraft type shall account for the anticipated range of variations in pilot eye height or viewing angle.

(4) The stopping position indicator shall show the stopping position for the aircraft for which guidance is being provided and shall provide closing rate information for purposes of enabling the pilot gradually decelerate the aircraft to a full stop at the intended stopping position.

(5) The stopping position indicator shall provide closing rate information over a distance of at least 10 m.

(6) Where stopping guidance is indicated by colour change, green shall be used to show that the aircraft can proceed and red to show that the stop point has been reached, except that for a short distance prior to the stop point, a third colour may be used to warn that the stopping point is close.



## **198. Advanced VDGS**

(1) An Advanced Visual Docking Guidance System (A-VDGS) shall be provided where it is operationally desirable to confirm the correct aircraft type for which guidance is being provided or to indicate the stand center line in use, where more than one is provided for.

(2) The A-VDGS shall be suitable for use by all types of aircraft for which the aircraft stand is intended.

(3) The A-VDGS shall be used only in conditions in which its operational performance is specified.

(4) The docking guidance information provided by an A-VDGS shall not conflict with that provided by a conventional visual docking guidance system on an aircraft stand where both types are provided and are in operational use.

(5) A method of indicating that the A-VDGS is not in operational use or is unserviceable shall be provided.

(6) The A-VDGS shall be located such that unobstructed and unambiguous guidance is provided to the person responsible for, and persons assisting, the docking of the aircraft throughout the docking manoeuvre.

(7) The A-VDGS shall provide, at minimum, the following guidance information at the appropriate stage of the docking manoeuvre—

- (a) an emergency stop indication;
- (b) the aircraft type and model for which the guidance is provided;
- (c) an indication of the lateral displacement of the aircraft relative to the stand center line;

- (d) the direction of azimuth correction needed to correct a displacement from the stand center line;
- (e) an indication of the distance to the stop position;
- (f) an indication when the aircraft has reached the correct stopping position; and
- (g) a warning indication where the aircraft goes beyond the appropriate stop position.

(8) The A-VDGS shall be capable of providing docking guidance information for all aircraft taxi speeds encountered during the docking manoeuver.

(9) Symbols and graphics used to depict guidance information shall be intuitively representative of the type of information provided.

(10) The time taken from the determination of the lateral displacement to its display shall not result in a deviation of the aircraft when operated in normal conditions from the stand center line greater than 1m.

(11) Information on the lateral displacement of the aircraft relative to the stand center line shall be provided not less than 25m prior to the stop position.

(12) Continuous closure distance and closure rate shall be provided from not less than 15m prior to the stop position.

(13) Throughout the docking manoeuver, an appropriate means shall be provided on the A-VDGS to indicate the need to bring the aircraft to an immediate halt and where such an event, which includes a failure of the A-VDGS, no other information shall be displayed.

(14) Provision to initiate an immediate halt to the docking procedure shall be made available to personnel responsible for the operational safety of the stand.

(15) Where provided, closure distance displayed in numerals shall be provided in meter integers to stop position and displayed to 1 decimal place of not less than 3m prior to stop position.

(16) The word “stop” in red characters shall be displayed when an immediate cessation of the docking manoeuver is required.

(17) The information on displacement of the aircraft relative to the stand center line and distance to stopping position, when displaced, shall be provided with the accuracy set out—

<b>A-VDGS recommended displacement accuracy</b>				
<b>Guidance information</b>	<b>Maximum deviation at stop position (stop area)</b>	<b>Maximum deviation at 9m from stop position</b>	<b>Maximum deviation at 15m from stop position</b>	<b>Maximum position at 25m from stop position</b>
Azimuth	±250 mm	±340 mm	±400 mm	±500 mm
Distance	±500 mm	±1,000 mm	±1,300 mm	Not specified

**199. Aircraft Stand manoeuvring guidance lights**

(1) The aircraft stand manoeuvring lights shall be provided to facilitate the positioning of an aircraft on a stand on a paved apron intended for use in poor visibility conditions, under adequate guidance provided by other means.

(2) Aircraft stand manoeuvring guidance lights shall be collocated with the aircraft stand markings.

(3) Aircraft stand manoeuvring guidance lights, other than those indicating a stop position, shall be fixed yellow lights, visible throughout the segments within which they are intended to provide guidance.

(4) The lights indicating a stop position shall be fixed unidirectional lights showing red.

(5) The lights used to delineate lead-in, turning guard lead-out lines shall be spaced at intervals of not more than 7.5m on curves and 15m on straight sections.

(6) The intensity of the lights shall be adequate for the condition of visibility and ambient light in which the use of the aircraft stand is intended.

(7) The lighting circuit shall be designed in such a way that the lights may be switched on to indicate that an aircraft stand is to be used and switched off to indicate that it is not to be used.

## **200. Road-holding position light**

(1) A road-holding position light shall be provided at each road-holding position serving a runway where it is intended that the runway will be used in runway visual range conditions less than a value of 350 m.

(2) A road-holding position light shall be located adjacent to the holding position marking 1.5 m ( $\pm 0.5$  m) from one edge of the road, left or right as appropriate to the traffic and road safety regulations.

(3) The road-holding position light shall comprise of a controllable red (stop) and green (go) traffic light normally controlled by air traffic services.

(4) The road-holding position light beam shall be unidirectional and aligned so as to be visible to the driver of a vehicle approaching the holding position.

(5) The intensity of the light beam shall be adequate for the conditions of visibility and ambient light in which the use of the holding position is intended, but shall not dazzle the driver.

(6) The flash frequency of the flashing-red light shall be between 30 and 60 flashes per minute.

## **201. Runway status lights**

(1) Where provided, Runway Entrance Lights (RELs) shall be offset 0.6m from the taxiway center line on the opposite side to the taxiway center line lights and begin at 0.6m before the runway-holding position extending to the edge of the runway.

(2) An additional single light shall be placed on the runway 0.6m from the runway center line and shall be aligned with the last taxiway RELs.

(3) Where two or more runway-holding positions are provided, the runway-holding position referred to in subregulation (1) is that closest to the runway.

(4) RELs shall consist of not less than five light units and shall be spaced at a minimum of 3.8m and a maximum of 15.2m longitudinally, depending upon the taxiway length involved, except for a single light installed near the runway center line.

(5) Where provided, Takeoff Holding Lights (THLs) shall be offset 1.8m on each side of the runway center line lights and extend in pairs starting at a point 115m from the beginning of the runway and thereafter, every 30m for not less than 450m.

(6) Where provided, RELs shall consist of a single line of fixed in pavement lights showing red in the direction of an aircraft approaching the runway.

(7) RELs shall illuminate as an array of each taxiway or runway intersection where they are installed less than two seconds after the system determines a warning is needed.

(8) The intensity and beam spread of RELs shall be in accordance with the specifications set out in Figures S4-12 and S4-14 of Schedule 6 to these Regulations.

(9) The aerodrome operator shall consider reduced beam width for some REL lights at acute angled runway or taxiway intersections to ensure the RELs are not visible to aircraft on the runway.

(10) Where provided, THLs shall consist of two rows of fixed in pavement lights showing red facing the aircraft take off.

(11) THLs shall illuminate as an array on the runway less than two seconds after the system determines a warning is needed.

(12) The intensity and beam spread of THLs shall be in accordance with the specifications set out in Figure S4-26 in Schedule 6 to these Regulations

(13) RELs and THLs shall be automated to the extent that the only control over each system will be to disable on or both systems.

## **202. Signs**

(1) Signs shall be provided to—

- (a) convey a mandatory instruction;
- (b) convey information on a specific location or destination on a movement area; or
- (c) to provide other information to meet the requirements of regulation 262(1).

(2) A variable message sign shall be provided where—

- (a) the instruction or information displayed on the sign is relevant only during a certain period of time; or
- (b) there is a need for variable predetermined information to be displayed on the sign to meet the requirements of regulation 262 (1).

(3) The signs shall be frangible.

(4) The signs located near a runway or taxiway shall be sufficiently low to preserve clearance for propellers and the engine pods of jet aircraft.

(5) The installed height of the sign shall not exceed the dimension shown in the appropriate column of Table 9.

**Table 9. Location distances for taxiing guidance signs including runway exit signs**

Sign height (mm)				Perpendicular distance from defined taxiway pavement edge to near side of sign	Perpendicular distance from defined runway pavement edge to near side of sign
Code number	Legend	Face (min.)	Installed (max)		
1 or 2	200	300	700	5-11 m	3-10 m
1 or 2	300	450	900	5-11 m	3-10 m
3 or 4	300	450	900	11-21 m	8-15 m
3 or 4	400	600	1 100	11-21 m	8-15 m

(6) The signs shall be rectangular with the longer side horizontal, as set out in Figures 32 and 33.

(7) The mandatory instruction signs shall be the only signs on the movement area utilising red.

(8) The inscriptions on a sign shall be in accordance with Schedule 6.

(9) The signs shall be illuminated in accordance with the provisions of Schedule 6 to these Regulations where they are intended for use—

- (a) in runway visual range conditions less than a value of 800m;
- (b) at night in association with instrument runways; or
- (c) at night in association with non-instrument runways where the code number is 3 or 4.










(10) The signs shall be retroreflective or illuminated in accordance with Schedule 6 to these Regulations where they are intended for use at night in association with non-instrument runways, where the code number is 1 or 2.

(11) A variable message sign shall show a blank face when not in use.

(12) In case of failure, the variable message sign referred to in subregulation (11) shall not provide information that could lead to unsafe action from a pilot or a vehicle driver.

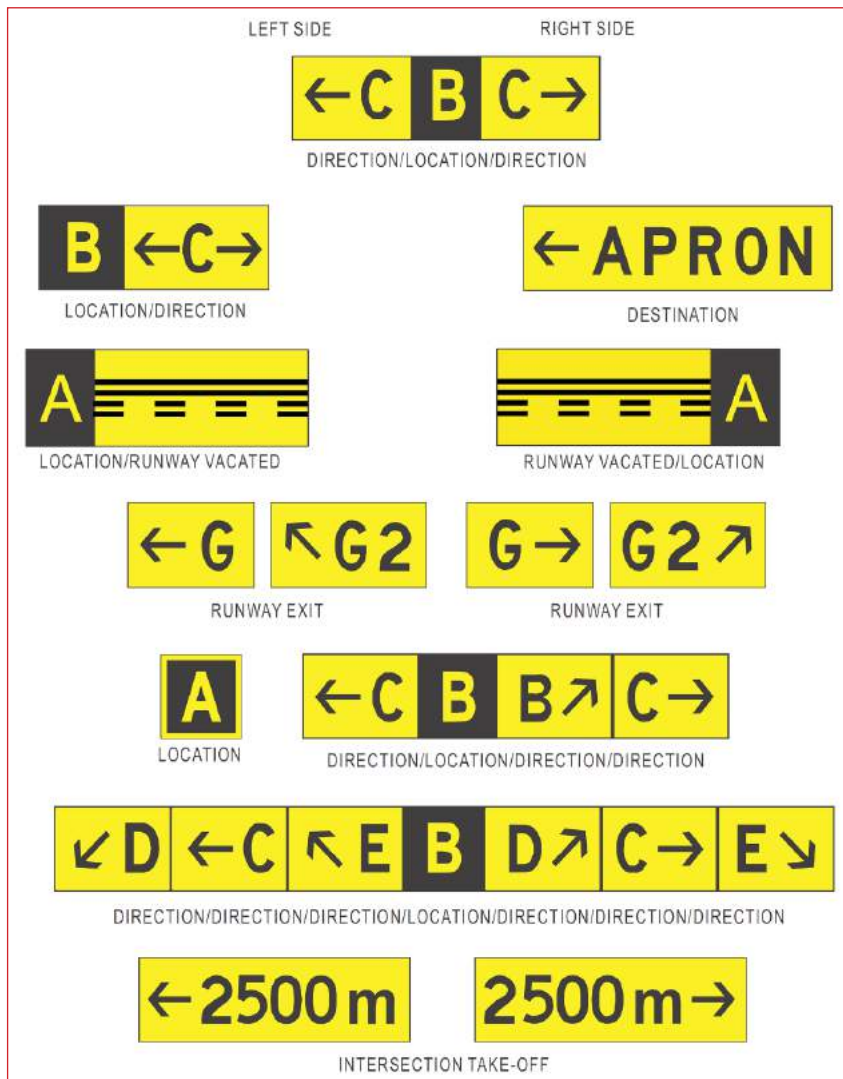
(13) The time interval to change from one message to another on a variable message sign shall be as short as practicable and shall not exceed 5 seconds.

**Figure 32. Mandatory instruction signs**

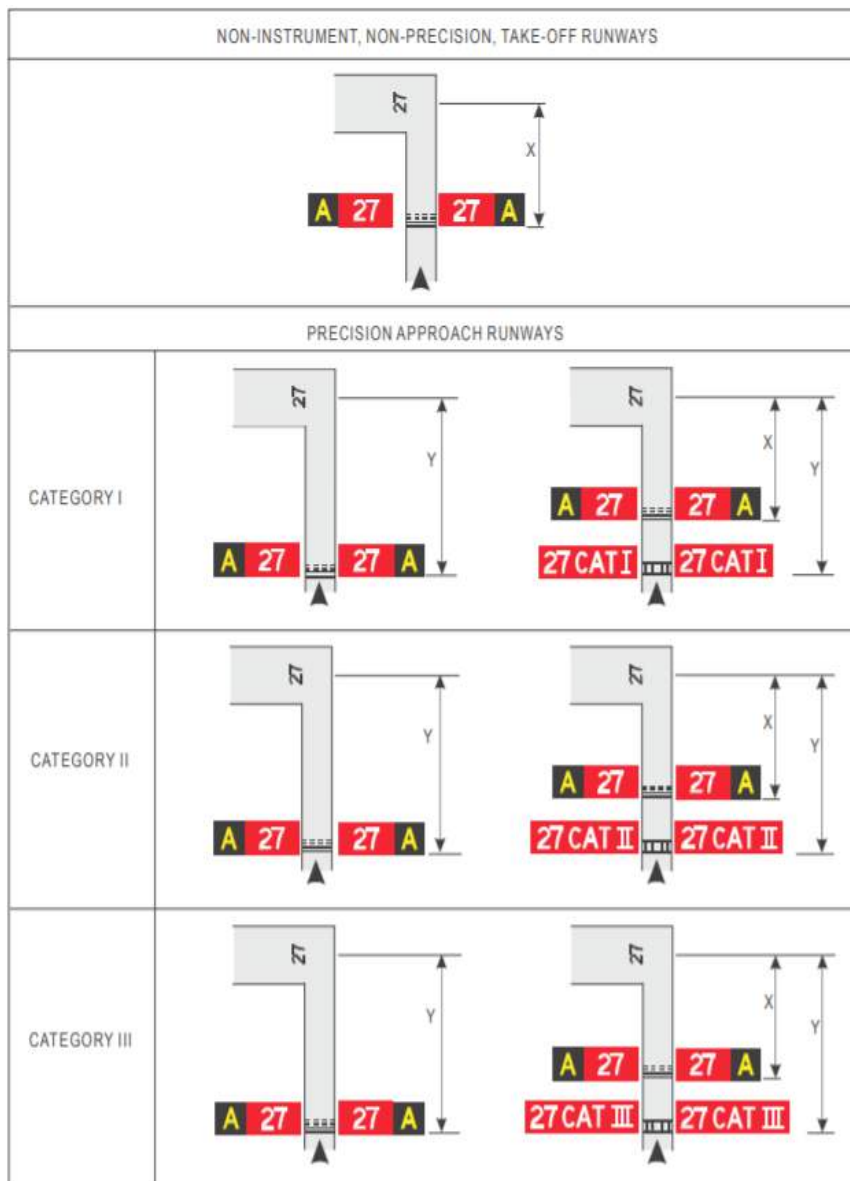
Runway designation of a runway extremity (Example)		Indicates a runway-holding position at a runway extremity
Runway designation of both extremities of a runway (Example)		Indicates a runway-holding position located at taxiway/runway intersection other than runway extremity
Category I hold position (Example)		Indicates a category I runway-holding position at the threshold of runway 25
Category II hold position (Example)		Indicates a category II runway-holding position at the threshold of runway 25
Category III hold position (Example)		Indicates a category III runway-holding position at the threshold of runway 25
Category II and III hold position (Example)		Indicates a joint category II and III runway-holding position at the threshold of runway 25
Category I, II and III hold position (Example)		Indicates a joint category I, II and III runway-holding position at the threshold of runway 25
NO ENTRY		Indicates that entry to an area is prohibited
Runway-holding position (Example)		Indicates a runway-holding position (in accordance with 3.12.3)



**Figure 33. Information signs**



**Figure 34. sign positions at taxiway/runway intersections**



### **203. Mandatory instruction signs**

(1) A mandatory instruction sign shall be provided to identify a location beyond which an aircraft taxiing or vehicle shall not proceed unless authorised by the aerodrome control tower.

(2) A mandatory instruction sign shall include runway designation signs, Category I, II or III holding position signs, runway-holding position signs, road-holding position signs and NO ENTRY signs.

(3) A pattern “A” runway-holding position marking shall be supplemented at a taxiway-runway intersection or a runway-runway intersection with a runway designation sign.

(4) A pattern “B” runway-holding position marking shall be supplemented with a Category I, II or III holding position sign.

(5) A pattern “A” runway-holding position marking at a runway-holding position established in accordance with regulation 107 (3) shall be supplemented with a runway-holding position sign.

(6) A runway designation sign at a taxiway or runway intersection shall be supplemented with a location sign in the outboard, farthest from the taxiway, position, where necessary.

(7) A NO ENTRY sign shall be provided where entry into an area is prohibited.

(8) A runway designation sign at a taxiway or runway intersection or a runway-runway intersection shall be located on each side of the runway-holding position marking facing the direction of approach to the runway.

(9) A Category I, II or III holding position sign shall be located on each side of the runway-holding position marking facing the direction of the approach to the critical area.

(10) A NO ENTRY sign shall be located at the beginning of the area to which entrance is prohibited on each side of the taxiway as viewed by the pilot.

(11) A runway-holding position sign shall be located on each side of the runway-holding position established in accordance with regulation 107 (3) facing the approach to the obstacle limitation surface or ILS critical area, where necessary.

(12) A mandatory instruction sign shall consist of an inscription in white on a red background.

(13) Where, owing to environmental or other factors, the conspicuity of the inscription on a mandatory instruction sign needs to be enhanced, the outside edge of the white inscription shall be supplemented by a black outline measuring 10mm in width for runway code numbers 1 and 2 and 20 mm in width for runway code numbers 3 and 4.

(14) The inscription on a runway designation sign shall consist of the runway designations of the intersecting runway properly oriented with respect to the viewing position of the sign, except that a runway designation sign installed in the vicinity of a runway extremity may show the runway designation of the concerned runway extremity only.

(15) The inscription on a Category I, II, III, joint II/III or joint I/II/III holding position sign shall consist of the runway designator followed by CAT I, CAT II, CAT III, CAT II/III or CAT I/II/III, where necessary.

(16) The inscription on a NO ENTRY sign shall be in accordance with Figure 26.

(17) The inscription on a runway-holding position sign at a runway-holding position established in accordance with regulation 107(3) shall consist of the taxiway designation and a number.

(18) Where installed, the inscriptions or symbol of Figure 32 shall be used.

#### **204. Information signs**

(1) An information sign shall be provided where there is an operational need to identify—

- (a) a specific location information; or
- (b) a routing giving direction or destination information.

(2) The information signs shall include direction signs, location signs, destination signs, runway exit signs, runway vacated signs and intersection take-off signs.

(3) A runway exit sign shall be provided where there is an operational need to identify a runway exit.

(4) A runway vacated sign shall be provided where the exit taxiway is not provided with taxiway center line lights and there is a need to indicate to a pilot leaving a runway the perimeter of the ILS critical area or the lower edge of the inner transitional surface, whichever is farther from the runway center line.

(5) An intersection take-off sign shall be provided where there is an operational need to indicate the remaining take-off run available (TORA) for intersection take-offs.

(6) Where necessary, a destination sign shall be provided to indicate the direction to a specific destination on the aerodrome..

(7) A combined location and direction sign shall be provided where it is intended to indicate routing information prior to a taxiway intersection.

(8) A direction sign shall be provided where there is an operational need to identify the designation and direction of taxiways at an intersection.

(9) A location sign shall be provided at an intermediate holding position.

(10) A location sign shall be provided in conjunction with a runway designation sign except at a runway and runway intersection.

(11) A location sign shall be provided in conjunction with a direction sign, except that the location sign may be omitted where an aeronautical study indicates that it is not needed.

(12) Where necessary, a location sign shall be provided to identify taxiways exiting an apron or taxiways beyond an intersection.

(13) Where a taxiway ends at an intersection such as a “T” and it is necessary to identify this, a barricade, direction sign or other appropriate visual aid shall be used.

(14) Except as specified in subregulations (16) and (24) information signs shall, wherever practicable, be located on the left-hand side of the taxiway in accordance with Table 9.

(15) At a taxiway intersection, information signs shall be located prior to the intersection and in line with the intermediate holding position marking and where there is no intermediate holding position marking, the signs shall be installed at least 60m from the center line of the intersecting taxiway where the code number is 3 or 4 and not less than 40m where the code number is 1 or 2.

(16) A runway exit sign shall be located on the same side of the runway as the exit is located and positioned as set out in Table 9.

(17) A runway exit sign shall be located before the runway exit point in line with a position at not less than 60m before the point of tangency where the code number is 3 or 4, and not less than 30m where the code number is 1 or 2.

(18) A runway vacated sign shall be located at least on one side of the taxiway and the distance between the sign and the center line of a runway shall not be less than the greater of the following—

- (a) the distance between the center line of the runway and the perimeter of the ILS critical area; or
- (b) the distance between the center line of the runway and the lower edge of the inner transitional surface.

(19) Where provided in conjunction with a runway vacated sign, the taxiway location sign shall be positioned outboard of the runway vacated sign.

(20) An intersection take-off sign shall be located at the left-hand side of the entry taxiway and the distance between the intersection takeoff sign and the center line shall not be less than 60m where the code number is 3 or 4 and not less than 45m where the code number is 1 or 2.

(21) A taxiway location sign installed in conjunction with a runway designation sign shall be positioned outboard of the runway designation sign.

(22) A destination sign shall not be collocated with a location or direction sign.

(23) An information sign other than a location sign shall not be collocated with a mandatory instruction sign.

(24) A direction sign, barricade or other appropriate visual aid used to identify a “T” intersection shall be located on the opposite side of the intersection facing the taxiway.

(25) A location sign shall consist of an inscription in yellow on a black background and where it is a stand-alone sign, it shall have a yellow border.

(26) The inscription on a runway exit sign shall consist of the designator of the exit taxiway and an arrow indicating the direction to follow.

(27) The inscription on a runway vacated sign shall depict the pattern A runway-holding position marking as set out in Figure 33.

(28) The inscription on an intersection take-off sign shall consist of a numerical message indicating the remaining take-off run available in meters plus an arrow, appropriately located and oriented, indicating the direction of the take-off as set out in Figure 27.

(29) The inscription on a destination sign shall comprise an alpha, alphanumerical or numerical message identifying the destination plus an arrow indicating the direction to proceed as set out in Figure 33.

(30) The inscription on a direction sign shall comprise an alpha or alphanumerical message identifying the taxiway plus an arrow or arrows appropriately oriented as set out in Figure 33.

(31) The inscription on a location sign shall comprise the designation of the location taxiway, runway or other pavement the aircraft is on or is entering and shall not contain arrows.

(32) Where it is necessary to identify each series of intermediate holding positions on the same taxiway, the location sign shall consist of the taxiway designation and a number.

(33) Where a location sign and direction signs are used in combination—

- (a) all direction signs related to left turns shall be placed on the left side of the location sign, and all direction signs related to right turns shall be placed on the right side of the location sign, except that where the junction consists of one intersecting taxiway, the location sign may alternatively be placed on the left-hand side;



- (b) the direction signs shall be placed such that the direction of the arrows departs increasingly from the vertical with increasing deviation of the corresponding taxiway;
- (c) an appropriate direction sign shall be placed next to the location sign where the direction of the location taxiway changes significantly beyond the intersection; and
- (d) adjacent direction signs shall be delineated by a vertical black line as set out in Figure 33.

(34) A taxiway shall be identified by a designator that is used only once on an aerodrome comprising a single letter, two letters or a combination of a letter or letters followed by a number.

(35) When designating taxiways, the use of words such as inner and outer shall be avoided wherever possible.

(36) When designating taxiways, the letters I, O or X shall not be used to avoid confusion with the numerals 1, 0 and closed marking.

(37) The use of numbers alone on the manoeuvring area shall be reserved for the designation of runways.

(38) An information sign other than a location sign shall consist of an inscription in black on a yellow background.

(39) Apron stand designators shall not be the same as taxiway designators.

## **205. VOR aerodrome checkpoint sign**

(1) Where a VOR aerodrome checkpoint is established, it shall be indicated by a VOR aerodrome checkpoint marking and sign.

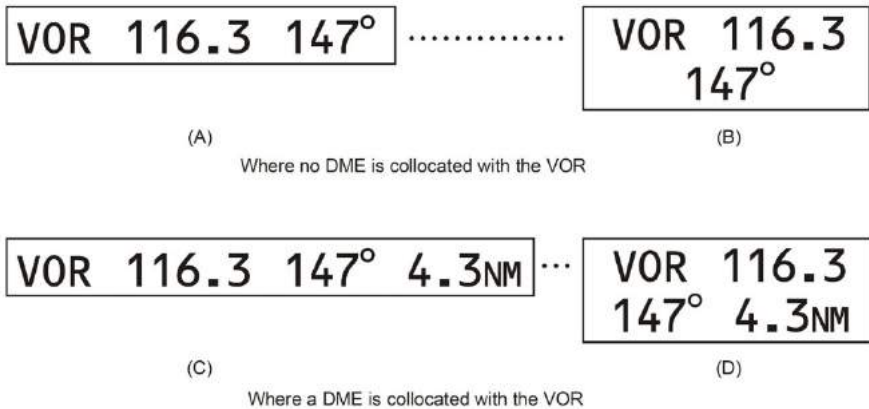
(2) A VOR aerodrome checkpoint sign shall be located as near as possible to the checkpoint so that the inscriptions are visible from the cockpit of an aircraft properly positioned on the VOR aerodrome checkpoint marking.

(3) A VOR aerodrome checkpoint sign shall consist of an inscription in black on a yellow background.

(4) The inscriptions on a VOR checkpoint sign shall be in accordance with one of the alternatives set out in Figure 28 in which —

- VOR is an abbreviation identifying this as a VOR checkpoint;
- 116.3 is an example of the radio frequency of the respective VOR;
- 147° is an example of the VOR bearing, to the nearest degree, which shall be indicated at the VOR checkpoint; and
- 4 . 3 NM is an example of the distance in nautical miles to a DME collocated with the VOR concerned.

**Figure 35. VOR aerodrome checkpoint sign**



**206. Aerodrome identification sign**

(1) An aerodrome identification sign shall be provided at every aerodrome where there is insufficient alternative means of visual identification.

(2) The aerodrome identification sign shall be placed on the aerodrome and shall be legible, in so far as is practicable, at all angles above the horizontal.

(3) The aerodrome identification sign shall consist of the name of the aerodrome.

(4) The colour selected for the sign shall have adequate conspicuity when viewed against its background.

(5) The characters of the sign shall have a height of not less than 3m.

### **207. Aircraft stand identification sign**

(1) An aircraft stand identification marking shall be supplemented with an aircraft stand identification sign where feasible.

(2) An aircraft stand identification sign shall be clearly visible from the cockpit of an aircraft entering the aircraft stand.

(3) An aircraft stand identification sign shall consist of an inscription in black on a yellow background.

### **208. Road-holding position sign**

(1) A road-holding position sign shall be provided at all road entrances to a runway.

(2) The road-holding position sign shall be located 1.5m from one edge of the road on the left at the holding position.

(3) A road-holding position sign shall consist of an inscription in white with a red background.

(4) The inscription on a road-holding position sign shall be in English, and in conformity with the Traffic and Road Safety Regulations and shall include the following—

- (a) a requirement to stop; and

(b) where appropriate—

- (i) a requirement to obtain Air Traffic Control clearance; and
- (ii) location designator.

(5) A road-holding position sign intended for night use shall be retroreflective or illuminated.

## **209. Markers**

(1) All markers shall be frangible.

(2) The markers located near a runway or taxiway shall be sufficiently low to preserve clearance for propellers and for the engine pods of jet aircraft.

## **210. Unpaved runways edge markers**

(1) Markers shall be provided where the extent of an unpaved runway is not clearly indicated by the appearance of its surface when compared with that of the surrounding ground.

(2) Where runway lights are provided, the markers shall be incorporated in the light fixtures.

(3) Where there are no lights, markers of flat rectangular or conical shape shall be placed in order to delimit the runway clearly.

(4) The flat rectangular markers shall have a minimum size of 1m by 3m and shall be placed with their long dimension parallel to the runway center line.

(5) The conical markers shall be of a height not exceeding 50cm.

## **211. Stopway edge markers**

(1) Stop way edge markers shall be provided where the extent of a stop way is not clearly indicated by its appearance compared with that of the surrounding ground.

(2) The stopway edge markers shall be sufficiently different from any runway edge markers used to ensure that the two types of markers cannot be confused.

### **212. Taxiway edge markers**

(1) Taxiway edge markers shall be provided on a taxiway where the code number is 1 or 2 and taxiway or edge lights or taxiway center line markers are not provided.

(2) Taxiway edge markers shall be installed at least at the same locations as would the taxiway edge lights had they been installed.

(3) A taxiway edge marker shall be retroreflective blue.

(4) The marked surface as viewed by the pilot shall be a rectangle and shall have a minimum viewing area of 150cm<sup>2</sup>.

(5) The taxiway edge markers shall be frangible and their height shall be sufficiently low to preserve clearance for propellers and for the engine pods of jet aircraft.

### **213. Taxiway center line markers**

(1) Taxiway center line markers shall be provided on a taxiway where the code number is 1 or 2 and where taxiway center line or edge lights or taxiway edge markers have not been provided.

(2) Taxiway center line markers shall be provided on a taxiway where the code number is 3 or 4 and taxiway center line lights shall not be provided where there is a need to improve the guidance provided by the taxiway center line marking.

(3) Taxiway center line markers shall be installed at least at the same location as would taxiway center line lights had they been installed.

(4) Taxiway center line markers shall be located on the taxiway center line marking except that they may be offset by not more than 30cm where it is not practicable to locate them on the marking.

(5) A taxiway center line marker shall be retroreflective green in colour.

(6) The marked surface when viewed by the pilot shall be rectangle and shall have a minimum viewing area of 20cm<sup>2</sup>.

(7) The taxiway center line markers shall be designed and fitted to withstand being run over by the wheels of an aircraft without damage either to the aircraft or to the markers themselves.

#### **214. Unpaved taxiway edge markers**

(1) Where the extent of an unpaved taxiway is not clearly indicated by its appearance compared with that of the surrounding ground, markers shall be provided.

(2) Where taxiway lights are provided, the markers shall be incorporated in the light fixtures.

(3) Where there are no lights, markers of conical shape shall be placed so as to delimit the taxiway clearly.

#### **215. Boundary markers**

(1) Boundary markers shall be provided at an aerodrome where the landing area has no runway.

(2) Boundary markers shall be spaced along the boundary of the landing area at intervals of not more than 200m—

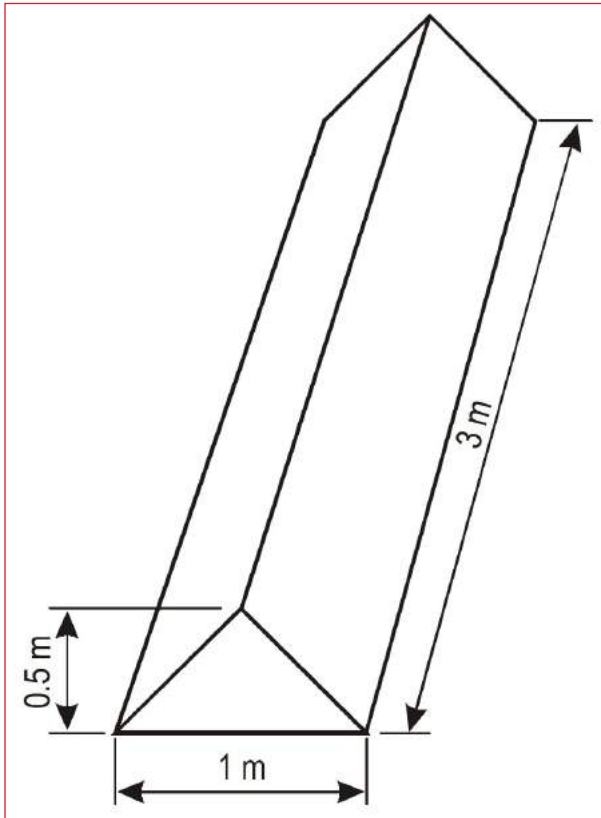
- (a) where the type set out in Figure 36 is used; or
- (b) approximately 90m where the conical type is used with a marker at any corner.

(3) Where provided, boundary markers shall be of a form similar to that set out in figure 36 or in the form of a cone not less than 50cm high and not less than 75cm in diameter at the base.

(4) The boundary markers shall be coloured to contrast with the background against which they are seen.

(5) A single colour, orange or red or two contrasting colours, orange and white or alternatively red and white, shall be used, except where such colours merge with the background.

**Figure 36 Boundary Markers**



PART XI—VISUAL AIDS FOR DENOTING OBSTACLES

**216. Provision of visual aids for denoting obstacles**

An aerodrome operator shall see to it that visual aids for denoting obstacles are provided and properly maintained for the purposes of the safe operation of aircraft at and around the aerodrome.

## **217. Marking and lighting of objects within lateral boundaries of obstacle limitation surfaces**

(1) Vehicles and other mobile objects, excluding aircraft, on the movement area of an aerodrome shall be considered as obstacles and shall be marked and, where the vehicles and aerodrome are used at night or in conditions of low visibility, they shall be lit, except that aircraft servicing equipment and vehicles used on aprons may be exempt from this requirement.

(2) Elevated aeronautical ground lights within the movement area shall be marked so that they are conspicuous during day.

(3) Obstacle lights shall not be installed on elevated ground lights or signs in the movement area.

(4) All obstacles within the distance set out in Table 2, column 11 or 12, from the center line of a taxiway, an apron taxiway or aircraft stand taxilane, shall be marked and, if the taxiway, apron taxiway or aircraft stand taxilane is used at night, shall be lit.

(5) A fixed obstacle that extends above a take-off climb surface within 3000m of the inner edge of the take-off climb surface shall be marked and, if the runway is used at night, the fixed obstacle shall be lit, except that—

- (a) such marking and lighting may be omitted where the obstacle is shielded by another fixed obstacle;
- (b) the marking may be omitted where the obstacle is lit by medium-intensity obstacle lights, Type A, during day and its height above the level of the surrounding ground does not exceed 150m;
- (c) the marking may be omitted where the obstacle is lit by high intensity obstacle lights during day; and
- (d) lighting may be omitted where the obstacle is a lighthouse and an aeronautical study establishes that the lighthouse light is sufficient.



- (6) (a) A fixed object, other than an obstacle, adjacent to a take-off climb surface shall be marked and, if the runway is used at night the fixed obstacle shall be lit where such marking and lighting are considered necessary;
- (b) the marking referred to in subparagraph (a) may be omitted where—
  - (i) the object is lit by medium-intensity obstacle lights, Type A, during day and its height above the level of the surrounding ground does not exceed 150m; or
  - (ii) the object is lit by high-intensity obstacle lights during day.

(7) A fixed obstacle that extends above an approach surface within 3 000m of the inner edge or above a transitional surface shall be marked and, where the runway is used at night, the fixed obstacle light shall be lit, except that—

- (a) such marking and lighting may be omitted where the obstacle is shielded by another fixed obstacle;
- (b) the marking may be omitted where the obstacle is lit by medium-intensity obstacle lights, Type A, during day and its height above the level of the surrounding ground does not exceed 150m;
- (c) the marking may be omitted where the obstacle is lit by high-intensity obstacle lights during day; and
- (d) the lighting may be omitted where the obstacle is a lighthouse and an aeronautical study establishes that the lighthouse light is sufficient.

(8) A fixed obstacle that extends above a horizontal surface shall be marked and, if the aerodrome is used at night, the fixed obstacle light shall be lit, except that—

- (a) such marking and lighting may be omitted where—

- (i) the obstacle is shielded by another fixed obstacle;
  - (ii) for a circuit extensively obstructed by immovable objects or terrain, procedures have been established for the purposes of safe vertical clearance below prescribed flight paths; or
  - (iii) an aeronautical study establishes that the obstacle is not of operational significance;
- (b) the marking may be omitted where the obstacle is lit by medium-intensity obstacle lights, Type A, during day and its height above the level of the surrounding ground does not exceed 150m;
  - (c) the marking may be omitted where the obstacle is lit by high intensity obstacle lights during day; and
  - (d) the lighting may be omitted where the obstacle is a lighthouse and an aeronautical study establishes that the lighthouse light is sufficient.

(9) A fixed object that extends above an obstacle protection surface shall be marked and, if the runway is used at night, the fixed obstacle shall be lit.

(10) Any other objects inside the obstacle limitation surfaces shall be marked or lit where an aeronautical study establishes that the object could constitute a hazard to aircraft.

(11) Overhead wires and cables, crossing a river, waterway, valley or highway shall be marked and their supporting towers marked and lit where an aeronautical study established that the wires or cables could constitute a hazard to aircraft.

## **218. Marking and lighting of objects outside lateral boundaries of obstacle limitation surfaces**

(1) All obstacles in areas beyond the limits of the obstacle limitation surfaces, which extend to a height of 150m or more above the ground elevation, shall be considered as obstacles and shall be

marked and lit, except that the marking may be omitted where the obstacle is lit by high-intensity obstacle lights during day.

(2) Other objects outside the obstacle limitation surfaces including objects adjacent to visual routes shall be marked or lit where an aeronautical study establishes that the object could constitute a hazard to aircraft.

(3) Overhead wires and cables crossing a river, waterway, valley or highway shall be marked and their supporting towers marked and lit where an aeronautical study establishes that the wires or cables could constitute a hazard to aircraft.

### **219. Marking or lighting of objects**

(1) The presence of objects that shall be lit in accordance with regulations 216, 217 and 218, shall be indicated by low, medium or high- intensity lights or a combination of such lights.

(2) Low-intensity obstacle lights, types A, B, C, D and E medium-intensity obstacle lights types A, B and C, high-intensity obstacle lights type A and B, shall be in accordance with the specifications set out in table 10 and Schedule 3 of these Regulations.

(3) In accordance with subregulations (1) and (2)—

- (a) the number and arrangement of low, medium or high intensity obstacle lights at each level to be marked shall be such that the object is indicated from every angle in azimuth;
- (b) where a light is shielded in any direction by another part of the object or by an adjacent object, additional lights shall be provided on the adjacent object or on the part of the object that is shielding the light, for purposes of retaining the general definition of the object to be lit; and
- (c) where the shielded light does not contribute to the definition of the object to be lit, it may be omitted.

**Table 10. Characteristics of obstacle lights**

1	2	3	4	5	6	7
Light Type	Colour	Signal type / (flash rate)	Peak intensity (cd) at given background luminance (b)			Light Distribution Table
			Day (Above 500 cd/ m2)	Twilight (50-500 cd/ m2)	Night (Below 50 cd/ m2)	
Low-intensity, Type A (fixed obstacle)	Red	Fixed	N/A	N/A	10	Table 11
Low-intensity, Type B (fixed obstacle)	Red	Fixed	N/A	N/A	32	Table 11
Low-intensity, Type C (mobile obstacle)	Yellow/ Blue (a)	Flashing (60-90fpm)	N/A	N/A	40	Table 11
Low-intensity, Type D (follow-me vehicle)	Yellow	Flashing (60-90fpm)	N/A	N/A	200	Table 11
Low-intensity, Type E	Red	Flashing (C)	N/A	N/A	32	Table 11 Type B
Medium-intensity, Type A	White	Flashing (20-60fpm)	20 000	20 000	2 000	Table 12
Medium-intensity, Type B	Red	Flashing (20-60fpm)	N/A	N/A	2 000	Table 12
Medium-intensity, Type C	Red	Fixed	N/A	N/A	2 000	Table 12
High-intensity, Type A	White	Flashing (40-60fpm)	200 000	20 000	2 000	Table 12
High-intensity, Type B	White	Flashing (40-60 fpm)	100 000	20 000	2 000	Table 12

**Table 11. Light distribution for low-intensity obstacle lights**

	Minimum intensity (a)	Maximum intensity (a)	Vertical beam spread (f)	
			Minimum beam spread	Intensity
Type A	10 cd (b)	N/A	10°	5 cd
Type B	32 cd (b)	N/A	10°	16 cd
Type C	40 cd (b)	400 cd	12° (d)	20 cd
Type D	200 cd (c)	400 cd	N/A (e)	N/A

Note. — This table does not include recommended horizontal beam spreads.

Regulation 219(3) requires 360° coverage around an obstacle. Therefore, the number of lights needed to meet this requirement will depend on the horizontal beam spreads of each light as well as the shape of the obstacle. Thus, with narrower beam spreads, more lights will be required.

- (a) 360° horizontal. For flashing lights, the intensity is read into effective intensity.
- (b) Between 2 and 10° vertical. Elevation vertical angles are referenced to the horizontal when the light is levelled.
- (c) Between 2 and 20° vertical. Elevation vertical angles are referenced to the horizontal when the light is levelled.
- (d) Peak intensity shall be located at approximately 2.5° vertical.
- (e) Peak intensity shall be located at approximately 17° vertical.
- (f) Beam spread is defined as the angle between the horizontal plane and the directions for which the intensity exceeds that mentioned in the “intensity” column.

**Table 12. Light distribution for medium-and high-intensity obstacle lights according to benchmark intensities of Table 10**

Benchmark intensity	Minimum requirements					Recommendations				
	Vertical elevation angle (b)			Vertical beam spread (c)		Vertical elevation angle (b)			Vertical beam spread (c)	
	0°		-1°			-1°	-10°			
	Minimum average intensity (a)	Minimum intensity (a)	Minimum intensity (a)	Minimum beam spread	Intensity (a)	Maximum intensity (a)	Maximum intensity (a)	Maximum intensity (a)	Maximum beam spread	Intensity (a)
200 000	200 000	150 000	75 000	3°	75 000	250 000	112 500	7 500	7°	75 000
100 000	100 000	75 000	37 500	3°	37 500	125 000	56 250	3 750	7°	37 500
20 000	20 000	15 000	7 500	3°	7 500	25 000	11 250	750	N/A	N/A
2 000	2 000	1 500	750	3°	750	2 500	1 125	75	N/A	N/A

Note— This table does not include recommended horizontal beam spreads. Regulation 219(3) requires 360° coverage around an obstacle. Therefore, the number of lights needed to meet this requirement will depend on the horizontal beam spreads of each light as well as the shape of the obstacle. Thus, with narrower beam spreads, more lights will be required.

- (a) 360° horizontal. All intensities are expressed in Candela. For flashing lights, the intensity is read into effective intensity.
- (a) Elevation vertical angles are referenced to the horizontal when the light unit is levelled.
- (a) Beam spread is defined as the angle between the horizontal plane and the directions for which the intensity exceeds that mentioned in the “intensity” column.

**220. Marking and lighting of mobile objects**

(1) All mobile objects to be marked shall be coloured or shall display flags.

(2) Where mobile objects are marked by colour, a single conspicuous colour, preferably red or yellowish green for emergency vehicles and yellow for service vehicles, shall be used, unless an aeronautical study establishes, to the satisfaction of the authority, that two contrasting colours are more conspicuous in the conditions experienced at the aerodrome.

(3) All flags used to mark mobile objects shall be displayed around, on top of or around the highest edge of the object and the flags shall not increase the hazard presented by the object they mark.

(4) In accordance with subregulations (1) and (2) —

(a) flags used to mark mobile objects shall not be less than 0.9m on each side and shall consist of a chequered pattern, each square having sides of not less than 0.3m;

(b) the colours of the pattern shall contrast each other and with the background against which they will be seen;

(c) orange and white or alternatively red and white shall be used, except where such colours merge with the background; and

(d) an extended beam spread shall be necessary under specific configuration and shall be justified by an aeronautical study.

(5) Low-intensity obstacle lights, type C, shall be displayed on vehicles and other mobile objects excluding aircraft.

(6) Low-intensity obstacle lights, type C, displayed on vehicles associated with emergency or security shall be of flashing blue colour while those displayed on other vehicles shall be of flashing yellow colour.

(7) Low-intensity obstacle lights, type D, shall be displayed on follow-me vehicles.

(8) Low-intensity obstacle lights on objects with limited mobility such as aerobridges shall be of fixed-red colour, and as a minimum be in accordance with the specifications for low-intensity obstacle lights, type A, set out in table 10 and the intensity of the lights shall be sufficient to ensure conspicuity considering the intensity of the adjacent lights and the general levels of illumination against which they would normally be viewed.

## **221. Marking of fixed objects**

(1) All fixed objects to be marked shall, whenever practicable, be coloured, but where this is not practicable, markers or flags shall be displayed on or above the objects, except that objects that are sufficiently conspicuous by their shape, size or colour need not be otherwise marked.

(2) When marking by colour—

(a) an object shall be coloured to show a chequered pattern where it has essentially unbroken surfaces and its projection on any vertical plane equals or exceeds 4.5m in both dimensions;

(b) the pattern referred to in paragraph (a) shall consist of rectangles of not less than 1.5m and not more than 3m on a side, the corners being of the darker colour;

(c) the colours of the pattern shall contrast with each other and with the background against which they are seen; and

(d) orange and white or alternatively red and white shall be used, except where such colours merge with the background as set out in Figure 37.

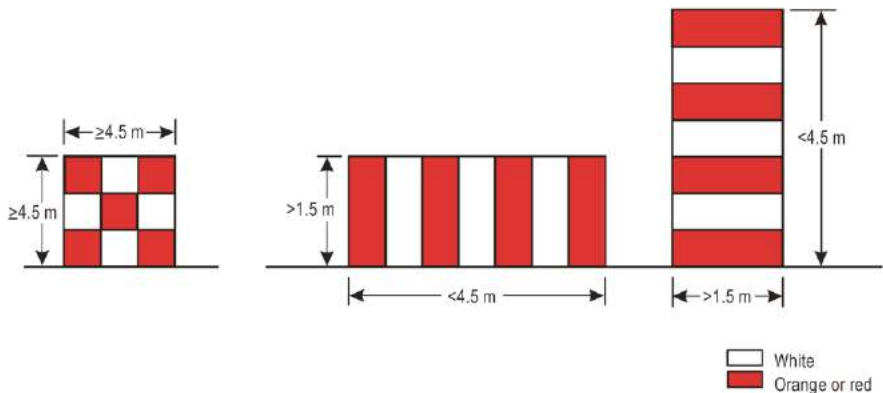
(3) An object shall be coloured to show alternating contrasting bands if—

(a) it has essentially unbroken surfaces and has one dimension, horizontal or vertical, greater than 1.5m and the other dimension, horizontal or vertical, less than 4.5m; or



- (b) it is of skeletal type with either a vertical or a horizontal dimension greater than 1.5m.
- (4) Subject to subregulation (3)—
  - (a) the bands shall be perpendicular to the longest dimension and shall have a width approximately 1/7 of the longest dimension or 30m, whichever is less;
  - (b) the colours of the bands shall contrast with the background against which they will be seen;
  - (c) colours of orange and white are used, except where such colours are not conspicuous when viewed against the background; and
  - (d) the bands on the extremities of the object shall be of the darker colour as set out in Figures 37 and 38.

**Figure 37. Basic marking patterns**



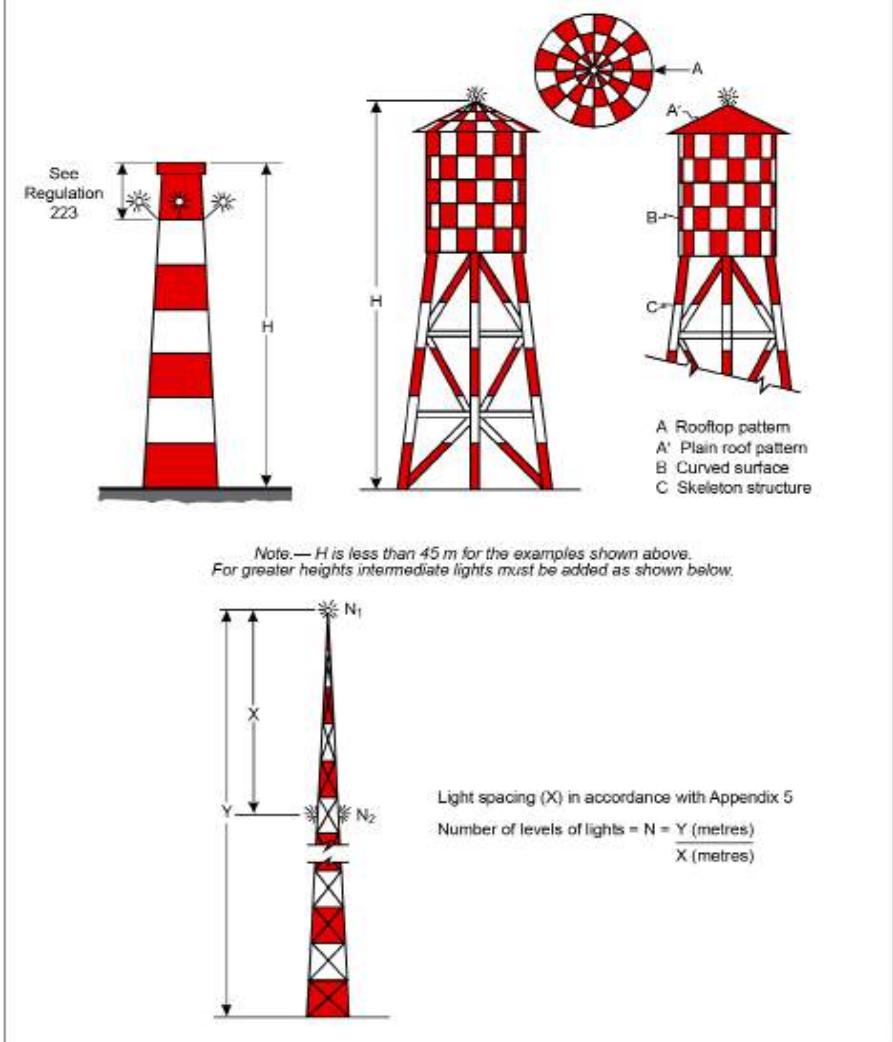
(5) The formula for determining the bandwidth and for having an odd number of bands, thus permitting both the top and bottom bands to be of the darker colour shall be as set out in Table 13.

**Table 13. – Marking band widths**

Longest dimension		Band width
Greater than	Not exceeding	
1.5 m	210 m	1/7 of longest dimension
210 m	270 m	1/9 of longest dimension
270 m	330 m	1/11 of longest dimension
330 m	390 m	1/13 of longest dimension
390 m	450 m	1/15 of longest dimension
450 m	510 m	1/17 of longest dimension
510 m	570 m	1/19 of longest dimension
570 m	630 m	1/21 of longest dimension

(6) An object shall be coloured in a single conspicuous colour if its projection on any vertical plane has both dimensions measuring less than 1.5m and the colour orange or red shall be used, except where such colours merge with the background, in which case it may be necessary to use a different colour from orange or red to obtain sufficient contrast.

**Figure 38: Marking and lighting of tall structures**



(7) Flags used to mark fixed objects shall be displayed around, on top of or around the highest edge of, the object and where flags are used to mark extensive objects or groups of closely spaced objects, they shall be displayed not less than every 15m and such flags shall not increase the hazard presented by the object they mark.

(8) Flags used to mark fixed objects shall not be less than 0.6m on each side of the object.

(9) Flags used to mark fixed objects shall be orange in colour or a combination of two triangular sections, one orange and the other white or one red and the other white, except that where such colours merge with the background, other conspicuous colours shall be used.

(10) Markers displayed on or adjacent to objects shall be located in conspicuous positions in order to retain the general definition of the object and shall be recognisable in clear weather from a distance of not less than 1,000m for an object to be viewed from the air and 300m for an object to be viewed from the ground in all directions in which an aircraft is likely to approach the object.

(11) In accordance with subregulation (10), the shape of markers shall be distinctive to the extent necessary to ensure that they are not mistaken for markers employed to convey other information, and they shall be such that the hazard presented by the object they mark is not increased.

(12) A marker shall be of one colour and where installed, white and red or white and orange markers shall be displayed alternately and the colour selected shall contrast with the background against which it will be seen.

## **222. Lighting of fixed objects**

(1) In the case of an object to be lit, one or more low- medium- or high-intensity obstacle lights shall be located as close as practicable to the top of the object and specifications on how a combination of low, medium or high-intensity lights on obstacles shall be displayed are set out in Schedule 7 to these Regulations.

(2) In the case of a chimney or any other structure of like function, the top lights shall be placed sufficiently below the top in order to minimise contamination by smoke, as set out in Figure 38.

(3) In the case of a tower or antenna structure indicated by high-intensity obstacle lights during day with an appurtenance, greater than 12m where it is not practicable to locate a high-intensity obstacle light on the top of the appurtenance, such a light shall be located at the highest practicable point and, if practicable, a medium-intensity obstacle light, Type A, mounted on the top.

(4) In the case of an extensive object or of a group of closely spaced objects to be lit that are—

- (a) penetrating a horizontal Obstacle Limitation Surface (OLS) or located outside an OLS, the top lights shall be arranged to indicate the points or edges of the object highest in relation to the OLS or above the ground, and to indicate the general definition and the extent of the objects; and
- (b) penetrating a sloping OLS, the top lights shall be so arranged to indicate the points or edges of the object highest in relation to the OLS, and to indicate the general definition and the extent of the objects and where two or more edges are of the same height, the edge nearest the landing area shall be marked.

(5) Where the OLS concerned is sloping and the highest point above the OLS is not the highest point of the object, additional obstacle lights shall be placed on the highest point of the object.

(6) Where lights are applied to display the general definition of an extensive object or a group of closely spaced objects and

- (a) low-intensity lights are used, they shall be spaced at longitudinal intervals not exceeding 45m; and

(b) medium-intensity lights are used, they shall be spaced at longitudinal intervals not exceeding 900 m.

(7) High-intensity obstacle lights, Type A and medium-intensity obstacle lights, Types A and B, located on an object shall flash simultaneously.

(8) The installation setting angles for high-intensity obstacle lights, Type A, shall be in accordance with Table 14, except that where high-intensity obstacle lights are intended for day use as well as night use, care shall be taken to ensure that the lights do not create disconcerting dazzle.

(9) The design, location and operation of high-intensity obstacle lights shall be in accordance with the requirements prescribed by the authority.

(10) Where, in the opinion of the authority or the aerodrome operator, the use of high-intensity obstacle lights, type A or medium-intensity obstacle lights, type A at night may dazzle pilots in the vicinity of an aerodrome, within approximately 10,000m radius, or cause significant environmental concerns, a dual obstacle lighting system shall be provided.

(11) The dual obstacle lighting system referred to in subregulation (10) shall comprise of high-intensity obstacle lights, type A, or medium intensity obstacle lights, type A, as appropriate, for daytime and twilight use and medium-intensity obstacle lights, type B or C, for night-time use.

### **223. Lighting of objects with height less than 45m above ground level**

(1) Low-intensity obstacle lights, type A or B, shall be used where the object is a less extensive one and its height above the surrounding ground is less than 45m.

(2) Where the use of low-intensity obstacle lights, type A or B, would be inadequate or an early special warning is required, then medium or high-intensity obstacle lights shall be used.

(3) Where the object is an extensive one including a group of buildings only medium intensity obstacle lights types A and C, shall be used; whereas medium intensity obstacle lights type B shall be used severally or in combination with low intensity obstacle lights type B.

(4) Medium-intensity obstacle lights, type A, B or C, shall be used where the object is an extensive one and medium-intensity obstacle lights, types A and C, shall be used alone, whereas medium intensity obstacle lights, type B, shall be used either alone or in combination with low-intensity obstacle lights, type B.

(5) A group of buildings shall be regarded as an extensive object.

**224. Lighting of objects with a height 45m or more to a height less than 150m above ground level**

(1) Medium intensity obstacle lights types A, B or C shall be used for lighting objects with a height of 45m to a height of less than 150m above ground level.

(2) Subject to subregulation (1) medium intensity obstacle lights for type A and C shall be used alone, whereas medium intensity obstacle lights shall be used either alone or in combination with low intensity obstacle lights type B.

(3) Where an object is indicated by medium-intensity obstacle lights, Type A, and the top of the object is more than 105m above the level of the surrounding ground or the elevation of tops of nearby buildings, when the object to be marked is surrounded by buildings, additional lights shall be provided at intermediate levels.

(4) Subject to subregulation (3), the additional intermediate lights shall be spaced as equally as practicable, between the top lights and ground level or the level of tops of nearby buildings, as necessary, with the spacing not exceeding 105m.

(5) Where an object is indicated by medium-intensity obstacle lights, type B, and the top of the object is more than 45m above the level of the surrounding ground or the elevation of tops of nearby buildings, and where the object to be marked is surrounded by buildings, additional lights shall be provided at intermediate levels.

(6) Subject to subregulation (5), the additional intermediate lights shall be alternately low-intensity obstacle lights, type B, and medium-intensity obstacle lights, type B, and shall be spaced as equally as practicable between the top lights and ground level or the level of tops of nearby buildings, as appropriate, with the spacing not exceeding 52m.

(7) Where an object is indicated by medium-intensity obstacle lights, type C, and the top of the object is more than 45m above the level of the surrounding ground or the elevation of tops of nearby buildings, when the object to be marked is surrounded by buildings, additional lights shall be provided at intermediate levels.

(8) Subject to subregulation (7) the additional intermediate lights shall be spaced as equally as practicable, between the top lights and ground level or the level of tops of nearby buildings, as appropriate, with the spacing not exceeding 52m.

(9) Where high-intensity obstacle lights, type A, are used, they shall be spaced at uniform intervals not exceeding 105m between the ground level and the top light as set out in regulation 222(1), except that where an object to be marked is surrounded by buildings, the elevation of the tops of the buildings may be used as the equivalent of the ground level when determining the number of light levels.

## **225. Lighting of objects with a height 150m or more above ground level**

(1) High-intensity obstacle lights, Type A, shall be used to indicate the presence of an object where its height above the level of the surrounding ground exceeds 150m and an aeronautical study has established that such lights are essential for the recognition of the object during day.



(2) Where high-intensity obstacle lights, Type A, are used, they shall be spaced at uniform intervals not exceeding 105 m between the ground level and the top light as set out in regulation 225(1), except that where an object to be marked is surrounded by buildings, the elevation of the tops of the buildings may be used as the equivalent of the ground level when determining the number of light levels.

(3) Where, in the opinion of the authority, or the aerodrome operator the use of high-intensity obstacle lights, type A, at night may dazzle pilots in the vicinity of an aerodrome, within approximately 10,000m radius or cause significant environmental concerns, only medium-intensity obstacle lights, type C, shall be used, whereas medium-intensity obstacle lights, type B, shall be used either alone or in combination with low- intensity obstacle lights, type B.

(4) Where an object is indicated by medium-intensity obstacle lights, type A, additional lights shall be provided at intermediate levels.

(5) The additional intermediate lights shall be spaced as equally as practicable, between the top lights and ground level or the level of tops of nearby buildings, as appropriate, with the spacing not exceeding 105m.

(6) Where an object is indicated by medium-intensity obstacle lights, type B, additional lights shall be provided at intermediate levels and the additional intermediate lights shall be alternately low- intensity obstacle lights, type B, and medium-intensity obstacle lights, type B, and shall be spaced as equally as practicable between the top lights and ground level or the level of tops of nearby buildings, as appropriate, with the spacing not exceeding 52m.

(7) Where an object is indicated by medium-intensity obstacle lights, type C, additional lights shall be provided at intermediate levels and these additional intermediate lights shall be spaced as equally as practicable, between the top lights and ground level or the level of tops of nearby buildings, as appropriate, with the spacing not exceeding 52m.

## **226. Marking of wind turbines**

(1) A wind turbine shall be marked or lit where the authority determines that the wind turbine is an obstacle.

(2) The rotor blades, nacelle and upper 2/3 of the supporting mast of wind turbines shall be painted white, unless otherwise determined by an aeronautical study.

## **227. Lighting of wind turbines**

(1) Where lighting is considered necessary, medium-intensity obstacle lights shall be used and in the case of a wind farm, the wind farm shall be regarded as an extensive object and the lights shall be installed—

- (a) to identify the perimeter of the wind farm;
- (b) respecting the maximum spacing between the lights along the perimeter in accordance with regulation 222(6), unless a dedicated assessment shows that a greater spacing can be used;
- (c) such that where flashing lights are used, they flash simultaneously;
- (d) such that within a wind farm any wind turbines of significantly higher elevation are also identified wherever they are located; and
- (e) at the locations prescribed in paragraphs (a), (b) and (d), respecting the following criteria—
  - (i) for wind turbines of less than 150m in overall height (hub height plus vertical blade height), medium-intensity lighting on the nacelle shall be provided;
  - (ii) for wind turbines ranging from 150m to 315m in overall height, in addition to the medium-intensity light installed on the nacelle, a second light serving as an alternate shall be provided in case of failure of

the operating light and the lights shall be installed such that the output of either light is not blocked by the other; and

- (iii) in addition, for wind turbines ranging from 150m to 315m in overall height, an intermediate level at half the nacelle height of not less than three low-intensity type E lights, as set out in regulation 220(3), shall be provided; and
- (iv) where an aeronautical study shows that low-intensity type E lights are not suitable, low-intensity type A or B lights may be used.

(2) The obstacle lights shall be installed on the nacelle in such a manner as to provide an unobstructed view for aircraft approaching from any direction.

(3) Where lighting is deemed necessary for a single wind turbine or a short line of wind turbines, the installation shall be in accordance with subregulation (1)(e) or as determined by an aeronautical study.

(4) The purpose of this regulation a wind farm means a group of two or more wind turbines.

## **228. Marking of overhead wires, cables and supporting towers**

(1) The wires and cables to be marked shall be equipped with markers and the supporting tower shall be coloured.

(2) The supporting towers of the overhead wires, cables, etc., that require marking shall be marked in accordance with regulation 221(1), (2), (3), (4), (5) and (6), except that the marking may be omitted where they are lit by high-intensity obstacle lights during day.

(3) The markers displayed on or adjacent to objects shall be located in conspicuous positions in order to retain the general definition of the object and shall be recognisable in clear weather from a distance

of not less than 1,000m for an object to be viewed from the air and 300m for an object to be viewed from the ground in all directions in which an aircraft is likely to approach the object.

(4) Subject to subregulation (3), the shape of the markers shall be distinctive to the extent necessary so that they are not mistaken for markers employed to convey other information, and they shall be such that the hazard presented by the object they mark is not increased.

(5) A marker displayed on an overhead wire cable, shall be spherical and have a diameter of not less than 60cm.

(6) The spacing between two consecutive markers or between a marker and a supporting tower shall be appropriate to the diameter of the marker, but in any case the spacing shall not exceed 30m where the marker diameter is 60cm progressively increasing with the diameter of the marker to 35m where the marker diameter is 80cm and further progressively increasing to a maximum of 40m where the marker diameter is of not less than 130cm; where multiple wires or cables are involved, a marker shall not be located not lower than the level of the highest wire at the point marked.

(7) A marker shall be of one colour and when installed, white and red, or white and orange markers shall be displayed alternately and the colour selected shall contrast with the background against which it will be seen.

(8) Where it is determined that an overhead wire or cable, needs to be marked but it is not practicable to install markers on the wire or cable, then high-intensity obstacle lights type B, shall be provided on their supporting towers.

## **229. Lighting of overhead wires, cables and supporting towers**

(1) High-intensity obstacle lights type B, shall be used to indicate the presence of a tower supporting overhead wires or cables where—

- (a) an aeronautical study determines that such lights are essential for the recognition of the presence of the wires or cables; or
- (b) it has not been found practicable to install markers on the wires or cables.

(2) Where high-intensity obstacle lights type B are used, they shall be located at the following three levels of the tower—

- (a) at the top of the tower;
- (b) at the lowest level of the catenary of the wires or cables; and
- (c) at approximately midway between the two levels, and in some cases, this may require locating the lights off the tower.

(3) High-intensity obstacle lights type B, indicating the presence of a tower supporting overhead wires or cables, shall flash sequentially; first the middle light, second the top light and lastly, the bottom light, and the intervals between flashes of the lights shall approximate the following ratios—

Flash interval between	Ratio of cycle time
middle and top light	1/13
top and bottom light	2/13
bottom and middle light	10/13

(4) Where high intensity obstacle lights are intended for day use as well as for night use, care shall be taken so that the lights do not create a disconcerting dazzle.

(5) Where in the opinion of the appropriate authority, the use of high-intensity obstacle lights type B, at night may dazzle pilots in the vicinity of an aerodrome, within approximately 10,000m radius, or cause significant environmental concerns, a dual obstacle lighting system shall be provided.

(6) The dual obstacle lighting system prescribed in sub-regulation (4) shall be composed of high-intensity obstacle lights, type B, for daytime and twilight use and medium-intensity obstacle lights, type B, for night-time use and where medium-intensity lights are used they shall be installed at the same level as the high-intensity obstacle light type B.

(7) The installation setting angles for high-intensity obstacle lights type B, shall be in accordance with the specifications in table 14.

**Table 14. Installation setting angles for high-intensity obstacle lights.**

Height of light unit above terrain (AGL)		Angle of the peak of the beam above the horizontal
Greater than	Not exceeding	
151 m		0°
122 m	151 m	1°
92 m	122 m	2°
	92 m	3°

## PART XII—VISUAL AIDS FOR DENOTING RESTRICTED USE AREAS

### 230. Marking of restricted use areas

(1) An aerodrome operator shall see to it that restricted use areas are marked in a manner that is visible to aircraft operating on the ground and in the air.

(2) An aerodrome operator shall adhere to visual aids requirements prescribed in these Regulations and see to it that aircraft operations can be conducted safely on the aerodrome.

### **231. Marking and lighting of closed runways and taxiways or parts of runways and taxiways**

(1) A closed marking shall be displayed on a runway or taxiway or a portion of the runway or taxiway which is permanently closed to the use of all aircraft.

(2) A closed marking shall be displayed on a temporarily closed runway or taxiway or portion of the runway or taxiway, except that such marking may be omitted where the closing is of a short duration, less than 3 days and adequate warning by air traffic services is provided.

(3) On a runway a closed marking shall be placed at each end of the runway, or a portion that is declared closed and additional markings shall be placed so that the maximum interval between the markings does not exceed 300m and on a taxiway a closed marking shall be placed at each end of the taxiway or portion of the taxiway closed.

(4) The closed marking shall be—

(a) of the form and proportions as set out in Figure 39, Illustration (a), where displayed on a runway;

(b) shall be of the form and proportions as set out in Figure 39 Illustration (b); and

(c) where displayed on a taxiway, the marking shall be white when displayed on a runway and shall be yellow when displayed on a taxiway.

(5) Where an area is temporarily closed, frangible barriers or markings utilising materials other than paint or other suitable means shall be used to identify the closed area.

(6) Where a runway or taxiway or portion of the runway or taxiway is permanently closed, all normal runway and taxiway markings shall be obliterated.

**Figure 39. Closed runway and taxiway markings**

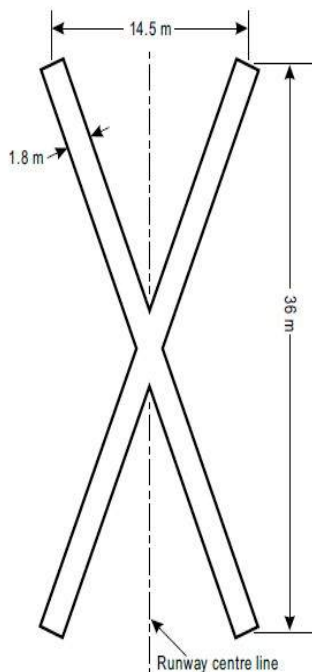


Illustration a) Closed runway marking

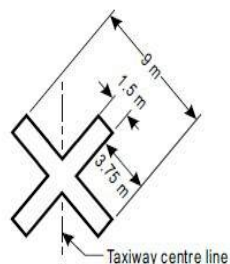


Illustration b) Closed taxiway marking

(7) Lighting on a closed runway or taxiway or a portion of the runway or taxiway shall not be operated, except as required for maintenance purposes.

(8) In addition to the closed markings, where the runway or taxiway or portion closed is intercepted by a usable runway or taxiway which is used at night, unserviceability lights shall be placed across the entrance to the closed area at intervals not exceeding 3m.

### **232. Marking of non-load-bearing surfaces**

(1) Shoulders for taxiways, holding bays and aprons and other non-load-bearing surfaces, which cannot readily be distinguished from load-bearing surfaces and which, if used by aircraft, might result in damage to the aircraft, shall have the boundary between such areas and the load-bearing surface marked by a taxi side stripe marking.



(2) A taxi side stripe marking shall be placed along the edge of the load-bearing pavement, with the outer edge of the marking approximately on the edge of the load-bearing pavement.

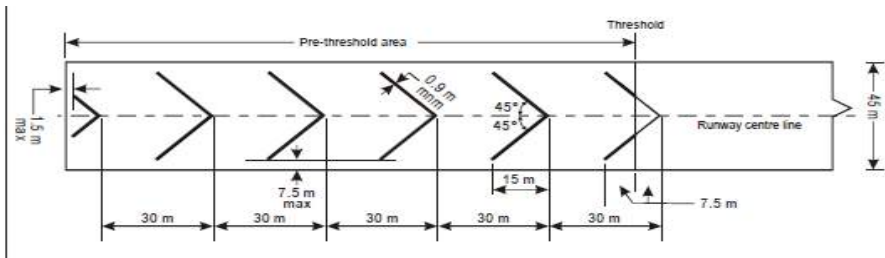
(3) A taxi side stripe marking shall consist of a pair of solid lines, each 15cm wide and spaced 15cm apart and shall have the same colour as the taxiway center line marking.

### 233. Marking of pre-threshold areas

(1) Where the surface before a threshold is paved and exceeds 60m in length and is not suitable for normal use by aircraft, the entire length before the threshold shall be marked with a chevron marking.

(2) A chevron marking shall point in the direction of the runway and be placed as set out in Figure 40.

**Figure 40. Pre-threshold marking**



(3) A chevron marking shall be of a conspicuous colour and contrast with the colour used for the runway markings and shall preferably be yellow.

(4) A chevron marking shall have an over-all width of not less than 0.9m.

### 234. Marking and lighting of unserviceable areas

(1) Unserviceability markers shall be displayed wherever any portion of a taxiway, apron or holding bay is unfit for the movement of aircraft but it is still possible for the aircraft to bypass the area safely

and on a movement area used at night, un-serviceability lights shall be used

(2) Unserviceability markers and lights shall be placed at intervals sufficiently close so as to delineate the unserviceable area.

(3) Unserviceability markers shall consist of conspicuous upstanding devices such as flags, cones or marker boards.

(4) An unserviceability light shall consist of a red fixed light and the light shall have the intensity sufficient to ensure conspicuity considering the intensity of the adjacent lights and the general level of illumination against which it would normally be viewed and in no case shall the intensity be less than 10cd of red light.

(5) An unserviceability cone shall not be less than 0.5m in height and shall have red, orange or yellow or any one of these colours in combination with white.

(6) An unserviceability flag shall not be less than 0.5m square and red, orange or yellow or any one of these colours in combination with white.

(7) An unserviceability marker board shall not be less than 0.5m in height and 0.9m in length, with alternate red and white or orange and white vertical stripes.

## PART XIII—ELECTRICAL SYSTEMS

### **235. Application of this Part**

This Part applies to aerodromes in Categories A and B unless otherwise specified by the authority.

### **236. Electrical power supply systems for air navigation services facilities**

(1) An aerodrome operator shall provide adequate primary power supply systems for the safe functioning of air navigation services and facilities.

(2) The design and provision of electrical power systems for aerodrome visual and radio navigation aids shall be such that an occurrence of equipment failure does not leave the pilot with inadequate visual and non-visual guidance or misleading information.

(3) The design and installation of the electrical systems shall take into consideration factors that can lead to malfunction, including electromagnetic disturbances, line losses and power quality.

(4) The electric power supply to the facilities for which secondary power is required shall be so arranged so that the facilities are automatically connected to the secondary power supply upon failure of the primary power source.

(5) Subregulation (3) shall apply in respect of non-instrument runways except that a secondary power supply for visual aids may not be provided where an emergency lighting system is provided and is capable of being deployed within fifteen minutes in accordance with the specifications in regulation 160.

(6) The time interval between failure of the primary source of power and the complete restoration of the services required in subregulation (13) shall be as short as practicable, except that for visual aids associated with non-precision, precision approach or take-off runways, the requirements in table 15 for maximum switch-over times shall be complied with.

(7) The provision of a definition of a switch-over time shall not require the replacement of an existing secondary power supply before 1<sup>st</sup> January, 2010.

(8) Notwithstanding subregulation (7) in the case of a secondary power supply installed after 4<sup>th</sup> November, 1999, the electric power supply connections to the facilities for which secondary

power is required shall be arranged so that the facilities are capable of meeting the requirements for maximum switch- over times set out in table 15.

(9) In the case of a precision approach runway, a secondary power supply capable of meeting the requirements set out in table 15, for the appropriate category of precision approach runway shall be provided and electric power supply connections to the facilities for which secondary power is required shall be arranged so that the facilities are automatically connected to the secondary power supply on failure of the primary source of power.

(10) In the case of a runway meant for take-off in runway visual range conditions less than a value of 800m, a secondary power supply capable of meeting the relevant requirements set out in table 15 shall be provided.

(11) In the case of an aerodrome where the primary runway is a non- precision approach runway, a secondary power supply capable of meeting the requirements in table 15 shall be provided, except that a secondary power supply for visual aids need not be provided for more than one non-precision approach runway.

(12) At an aerodrome where the primary runway is a non-instrument runway, a secondary power supply capable of meeting the requirements in subregulation (6) shall be provided, except that a secondary power supply for visual aids need not be provided where an emergency lighting system is provided and capable of being deployed in 15 minutes.

(13) An aerodrome operator shall provide the following aerodrome facilities with secondary power supply capable of supplying power in the case of a failure of the primary power supply—

- (a) the signalling lamp and the minimum lighting necessary to enable air traffic services personnel to carry out their duties;
- (b) all obstacle lights which, in the opinion of the authority are essential for the safe operation of aircraft;
- (c) approach, runway and taxiway lighting, as specified in subregulations (9) to (12);
- (d) meteorological equipment;
- (e) essential security lighting, where provided in accordance with regulation 264(5);
- (f) essential equipment and facilities for the aerodrome emergency agencies;
- (g) floodlighting on a designated isolated aircraft parking position if where; and
- (h) illumination of apron areas over which passengers may walk.

(14) The maximum switch-over time between failure of the primary source of power and the secondary source of power for the services shall be as set out in Table 15.

**Table 15 - Secondary power supply requirements**

Runway Type	Lighting aids requiring power	Maximum switch-over time
Non-instrument	Visual approach slope indicators <sup>a</sup>	15 seconds
	Runway edge <sup>b</sup>	15 seconds
	Runway threshold <sup>b</sup>	15 seconds
	Runway end <sup>b</sup>	15 seconds
	Obstacle	15 seconds
Non-precision approach	Approach lighting system	15 seconds
	Visual approach slope indicators <sup>a,d</sup>	15 seconds
	Runway edge <sup>d</sup>	15 seconds
	Runway threshold <sup>d</sup>	15 seconds
	Runway end	15 seconds
	Obstacle <sup>a</sup>	15 seconds
Precision approach category I	Approach lighting system	15 seconds
	Visual approach slope indicators <sup>a,d</sup>	15 seconds
	Runway edge <sup>d</sup>	15 seconds
	Runway threshold <sup>d</sup>	15 seconds
	Runway end	15 seconds
	Essential taxiways <sup>a</sup>	15 seconds
	Obstacle <sup>a</sup>	15 seconds

Precision approach category II	Inner 300m of the approach lighting system	1 second
	Other parts of the approach lighting system	15 seconds
	Obstacle <sup>a</sup>	15 seconds
	Runway edge	15 seconds
	Runway threshold	1 second
	Runway end	1 second
	Runway center line	1 second
	Runway touchdown zone	1 second
	All stop bars	1 second
	Essential taxiway	15 seconds
Runway meant for take-off in runway visual range conditions less than a value of 800m	Runway edge	15 seconds <sup>c</sup>
	Runway end	1 second
	Runway center line	1 second
	All stop bars	1 second
	Essential taxiway <sup>a</sup>	15 seconds
	Obstacle <sup>a</sup>	15 seconds
<p>(a) Supplied with secondary power when their operation is essential to the safety of flight operation.</p> <p>(b) See Part XIII—Visual aids for air navigation, regarding the use of emergency lighting.</p> <p>(c) One second where no runway center line lights are provided.</p> <p>(d) One second where approaches are over hazardous or precipitous terrain.</p>		

(15) In this regulation, “switch-over time” means the time required for the actual intensity of a light measured in a given direction to fall from fifty percent and recover to fifty percent during a power supply changeover, where the light is being operated at intensities of twenty five percent or more.

(16) The requirements for a secondary power supply shall be met by either of the following—

- (a) independent public power, which is a source of power supplying the aerodrome service from a substation other than the normal substation through a transmission line following a route different from the normal power supply route, such that the possibility of a simultaneous failure of the normal and independent public power supplies is extremely remote; or
- (b) standby power units, which are engine generators and batteries, from which electric power can be obtained.

### **237. Electrical system design**

(1) In case of a runway meant for use in runway visual range conditions less than a value of 550m, the electrical systems for the power supply, lighting and control of the lighting systems set out in table 15 shall be designed so that an equipment failure will not leave the pilot with inadequate visual guidance or misleading information.

(2) Where the secondary power supply of an aerodrome is provided by the use of duplicate feeders, such supplies shall be physically and electrically separate so as to achieve the required level of availability and independence.

(3) Where a runway forming part of a standard taxi-route is provided with runway lighting and taxiway lighting, the lighting systems shall be interlocked to prevent the possibility of simultaneous operation of both forms of lighting.

### **238. Monitoring of electrical systems**

(1) A system of monitoring shall be employed by the aerodrome operator to indicate the operational status of the lighting systems.

(2) Where lighting systems are used for aircraft control purposes, such systems shall be monitored automatically so as to provide



an indication of any fault which may affect the control functions and this information shall be relayed to the air traffic service unit.

(3) Where a change in the operational status of lights has occurred, an indication may be provided within two seconds for a stop bar at a runway holding position and within five seconds for all other types of visual aids.

(4) In the case of a runway meant for use in runway visual range conditions less than a value of 550m, the lighting systems set out in table 15 shall be monitored automatically so as to provide an indication where the serviceability level of any element falls below the minimum serviceability level specified in regulation 281(9) to (18) and this information shall be relayed to the maintenance crew.

(5) In the case of a runway meant for use in runway visual range conditions less than a value of 550m, the lighting systems set out in table 15 shall be monitored automatically to provide an indication when the serviceability level of any element falls below the minimum level specified below which operations shall not continue; and this information shall be relayed to the air traffic services unit and displayed in a prominent position.

#### PART XIV—AERODROME OPERATIONAL SERVICES, EQUIPMENT, INSTALLATIONS AND FACILITIES

### **239. Immigration, customs and excise aerodromes**

The authority may, in consultation with the authorities responsible for immigration, customs and excise, notify through the relevant publications of any aerodrome which is introduced as, or ceases to be a place for landing or departure of aircraft for purposes of the laws relating to immigration, customs and excise.

### **240. Supply of aviation fuel to aircraft**

(1) An operator of an aviation fuel installation at an aerodrome shall not cause or permit any aviation fuel to be delivered to that installation or drawn from it, to an aircraft unless —

- (a) the aviation fuel is delivered to the installation and the operator of the aviation fuel installation is satisfied that —
  - (i) the installation is capable of storing and dispensing the fuel so as not to render it unfit for use in an aircraft;
  - (ii) the installation is marked in an appropriate manner to the grade of the fuel stored or where different grades are stored in different parts, that each part is marked;
  - (iii) the fuel has been sampled and is of the grade appropriate to that installation or part of the installation as the case may be and is fit for use in an aircraft; and
- (b) aviation fuel is dispensed from the installation, the operator of the aviation fuel installation is satisfied after sampling, that the fuel is fit for use in an aircraft.

(2) A person shall not cause or permit aviation fuel to be dispensed for use in an aircraft where that person knows or has reason to believe that the aviation fuel is not fit for use in an aircraft.

(3) An operator of an aviation fuel installation shall not on an aerodrome, shall not supply fuel to an aircraft except at a place and in a manner approved by the aerodrome operator.

(4) An operator shall subject to the approval granted under subregulation (3), comply with any conditions the aerodrome operator may impose, in order to safeguard persons or property on the ground.

(5) An operator of an aviation fuel installation shall keep a written record in respect of every installation managed by him or her.

- (6) The record referred to in subregulation (5) shall include —
- (a) particulars of the grade and quantity of aviation fuel delivered and the date of delivery;
  - (b) particulars of all samples taken of the aviation fuel and of the results of the tests of those samples; and
  - (c) particulars of the maintenance and cleaning of the installation including the dates of each maintenance and cleaning exercise.

(7) An operator of an aviation fuel installation shall preserve the written record referred in subregulation (5) for a period of twelve months or more as the authority may determine and shall, within a reasonable time of being requested by an authorised person, deliver the record to that person.

(8) Where it appears to the authority, aerodrome operator or an authorised person that aviation fuel is intended or likely to be delivered in contravention of this regulation, the authority, aerodrome operator, or authorised person may direct the operator of an aviation fuel installation not to permit aviation fuel to be dispensed from that installation until the directive is revoked by the authority, aerodrome operator or authorised person,

- (9) For the purpose of this regulation—
- (a) “aviation fuel” means fuel intended for use in an aircraft; and
  - (b) “aviation fuel installation” means any apparatus or container, including a vehicle designed, manufactured or adapted for the storage of aviation fuel or for the delivery of fuel to an aircraft.

#### **241. Aerodrome emergency planning**

(1) An aerodrome operator shall establish an aerodrome emergency plan at the aerodrome, which shall be commensurate with the aircraft operations and other activities conducted at the aerodrome.

(2) The aerodrome emergency plan shall set out the procedures for coordinating the responses of the different aerodrome agencies and services and other agencies in the surrounding community that could be of assistance in responding to an emergency.

(3) An aerodrome emergency plan shall provide for the coordination of the actions to be taken in the event of an emergency occurring at the aerodrome or in its vicinity.

(4) The aerodrome emergencies include—

- (a) aircraft emergencies;
- (b) sabotage including bomb threats;
- (c) unlawful seizure of aircraft;
- (d) dangerous goods occurrences;
- (e) building fires;
- (f) natural disasters; and
- (g) public health emergencies.

(5) Subject to subregulation (4) (g), public health emergencies include—

- (a) increased risk of travellers or cargo spreading a communicable disease internationally through air transport; and
- (b) severe outbreak of a communicable disease potentially affecting a large proportion of aerodrome staff.

(6) The emergency plan shall coordinate responses or participation of all existing agencies whose assistance is required in the event of an emergency, including—

- (a) at an aerodrome—
  - (i) air traffic control unit;
  - (ii) rescue and fire-fighting services;

- (iii) aerodrome administration;
  - (iv) medical and ambulance services;
  - (v) aircraft operators;
  - (vi) security services; and
  - (vii) airport police unit;
- (b) outside the aerodromes —
- (i) fire departments;
  - (ii) police services;
  - (iii) health authorities including medical, ambulance services, hospitals and public health services;
  - (iv) the military forces; and
  - (v) harbour patrol or coast guard.

(7) The aerodrome emergency plan shall provide for cooperation and coordination with the rescue coordination center as necessary.

(8) The aerodrome emergency plan shall include at least the following—

- (a) the types of emergencies planned for;
- (b) the names of the agencies involved in the plan;
- (c) the responsibility and role of each agency, the emergency operation center and the command post for each type of emergency;
- (d) names and contacts of offices or people to be contacted in the case of a particular emergency; and
- (e) a grid map of the aerodrome and its immediate vicinity.

(9) In developing the aerodrome emergency plan, the aerodrome operator shall take into consideration the human factor principles for the purpose of securing optimum response by all existing agencies participating in the emergency operations.

(10) This regulation applies to aerodromes in Category A.

(11) The authority may apply this regulation to aerodromes in Categories B and C.

#### **242. Emergency planning committee**

(1) An aerodrome operator shall form an emergency planning committee to discuss, determine and implement emergency planning arrangements commensurate with the size and type of aircraft that use the aerodrome.

(2) This regulation applies to aerodromes in Category A.

(3) The authority may where it considers it necessary apply this regulation to aerodromes in Categories B and C.

#### **243. Emergency operation center and command post**

(1) An aerodrome operator shall provide a fixed emergency operations center and a mobile command post for use during an emergency.

(2) The emergency operations center shall be part of the aerodrome facilities and shall be responsible for the overall coordination and general direction of the response to an emergency.

(3) The command post shall be a facility capable of being moved rapidly to the site of an emergency, when required and shall undertake the local coordination of those agencies responding to the emergency.

(4) An aerodrome operator shall assign a person to assume

control of the emergency operations center and where necessary, another person to control the mobile command post.

(5) An aerodrome operator shall provide adequate communication systems linking the command post and the emergency operations center with each other and with the participating agencies in accordance with the emergency plan.

(6) The communication systems referred to in subregulation (5) shall be consistent with the requirements of the aerodrome.

(7) This regulation applies to aerodromes in Category A.

(8) The authority may where it considers it necessary apply this regulation to aerodromes in Category B.

#### **244. Aerodrome emergency exercises**

(1) The aerodrome emergency plan shall contain procedures for periodic testing of the adequacy of the plan and for reviewing the results in order to improve its effectiveness and the periodic testing shall include all participating agencies and associated equipment.

(2) The aerodrome emergency plan referred to in subregulation (1) shall be tested by conducting—

(a) a full-scale aerodrome emergency exercise at intervals not exceeding two years and partial emergency exercises in the intervening year to see to it that any deficiencies found during the full-scale aerodrome emergency exercise; or

(b) a series of modular tests commencing in the first year and ending in a full-scale aerodrome emergency exercise at intervals not exceeding three years,

and reviewed thereafter or after an actual emergency, so as to correct any deficiency found during such exercises or actual emergency.

(3) The purpose of a full-scale exercise is to test the capacity of the plan to cope with different types of emergencies.

(4) The purpose of a partial exercise is to test the capacity of the response to individual participating agencies and components of the plan, such as the communications system.

(5) The modular tests shall be used to enable concentrated effort on specific components of established emergency plans.

(6) This regulation applies to aerodromes in Category A.

(7) The authority may where it considers it necessary apply this regulation to aerodromes in Category B.

#### **245. Emergencies in difficult environment**

(1) Where an aerodrome is located close to water or swampy areas and where a significant portion of approach or departure operations takes place over these areas, the aerodrome emergency plan shall include the availability of and coordination with appropriate specialist rescue services to respond to emergencies.

(2) In the case of an aerodrome located close to a water body, a swampy area, or difficult terrain, the aerodrome emergency plan shall include the establishment, testing and assessment of a pre-determined response for the specialist rescue services at regular intervals.

(3) An assessment of the approach and departure areas within 1,000 m of the runway threshold shall be carried out to determine the options available for intervention.

(4) This regulation applies to aerodromes in Category A.

(5) This regulation may apply to an aerodrome in Categories B and C where deemed necessary by the authority.

#### **246. Establishment of aerodrome rescue and fire-fighting services**

(1) Rescue and firefighting equipment and services shall be provided at the aerodrome serving commercial air transport operations.



(2) An aerodrome operator shall put in place rescue and fire-fighting equipment and services commensurate with the category of the aerodrome.

(3) Public or private organisations, suitably located and equipped, may be designated to provide the rescue and fire-fighting services and where designated the fire station housing these organisations shall be located at the aerodrome, although an off-aerodrome organisation is not precluded from providing rescue and firefighting services provided the response time can be met.

(4) Where an aerodrome is located close to a water body, a swampy area or difficult terrain and where a significant portion of approach or departure operations takes place over such an area, specialist rescue services and fire-fighting equipment appropriate to the hazard and risk shall be made available.

(5) Subject to subregulation (3), the aerodrome operator shall plan and deploy the necessary life-saving flotation equipment as expeditiously as possible in a number commensurate with the largest aeroplane normally using the aerodrome.

(6) This regulation applies to aerodromes in Categories A and B.

(7) The authority may prescribe alternative means of compliance with this regulation for aerodromes in Category C.

#### **247. Determination of aerodrome rescue and fire-fighting category**

(1) The aerodrome rescue and fire-fighting services category shall be determined in accordance with table 16 and shall be based on the longest aeroplane that normally uses the aerodrome, and its fuselage width.

(2) Where after selecting the aerodrome category appropriate to the overall length of the longest aeroplane, that aeroplane's fuselage

width is found to be greater than the maximum width set out in table 16, column 3, for that category, then the category for that aeroplane shall be one category higher.

**Table 16 – Aerodrome category for rescue and fire-fighting**

<i>Aerodrome fire category</i>	<i>Aircraft overall length</i>	<i>Maximum fuselage width</i>
1	0 M up to but not including 9 M	2M
2	9 M up to but not including 12 M	2M
3	12 M up to but not including 18 M	3M
4	18 M up to but not including 24 M	4M
5	24 M up to but not including 28 M	4M
6	28 M up to but not including 39 M	5M
7	39 M up to but not including 49 M	5M
8	49 M up to but not including 61 M	7M
9	61 M up to but not including 76 M	7M
10	76 M up to but not including 90 M	8M

**248. Level of protection for rescue and fire-fighting services**

(1) The level of protection provided at an aerodrome for rescue and fire-fighting shall be appropriate to the aerodrome category determined under regulation 247, except that, where the number of movements of the aeroplanes in the highest category normally using the aerodrome is less than 700 in the busiest consecutive three months, the level of protection provided shall not be less than one category below the determined category.

(2) During anticipated periods of reduced activity, the level of protection available shall not be less than that needed for the highest category of aeroplane intended to use at the aerodrome during that time irrespective of the number of movements.

## **249. Extinguishing agents**

(1) Both principal and complementary extinguishing agents shall be provided at an aerodrome.

(2) The principal extinguishing agent shall be—

(a) a foam meeting the minimum performance level A;

(b) a foam meeting the minimum performance level B;

(c) a foam meeting the minimum performance level C; or

(d) a combination of these agents,

except that the principal extinguishing agent for aerodromes in Categories 1, 2 and 3 shall preferably meet the minimum performance level B or C foam.

(3) The complementary extinguishing agent shall be a dry chemical powder suitable for extinguishing hydrocarbon fires.

(4) When selecting dry chemical powder for use with foam, care shall be taken to see to it that the compatibility and alternate complementary agents having equivalent fire-fighting capability are utilised.

(5) The amounts of water for foam production and the complementary agents to be provided on the rescue and fire-fighting vehicles shall be the aerodrome category determined in accordance with regulation 248(1), (2) and (3) and Table 17, except that for aerodrome fire-fighting Categories 1 and 2, up to one hundred percent of water may be replaced by a complementary agent.

(6) For the purpose of agent substitution, 1 kilogram of complementary agent shall be taken as equivalent to 1.0 litres of water for production of foam for meeting performance level A.

- (7) (a) The amounts of water specified for foam production shall be predicated on an application rate of 8.2 L/min/m<sup>2</sup> for a foam meeting performance level A, 5.5 L/min/m<sup>2</sup> for a foam meeting performance level B; and 3.75 L/min/m<sup>2</sup> for a foam meeting performance level C; and
- (b) where any other complementary agent is used, the substitution ratios shall be checked.

**Table 17 - Minimum usable amounts of extinguishing agents**

Aerodrome fire Category	Foam meeting performance level A		Foam meeting performance level B		Foam meeting Performance level C		Complementary agents	
	Water (L)	Discharge rate Foam solution/minute (L)	Water (L)	Discharge rate Foam solution/minute (L)	Water (L)	Discharge rate foam solution/minute (L)	Dry Chemical Powder (DCP) (kg)	Discharge rate (kg/sec)
(1)	(2)	(3)	(4)	(5)	(6)	(7)	(8)	(9)
1	350	350	230	230	160	160	45	2.25
2	1000	800	670	550	460	360	90	2.25
3	1800	1300	1200	900	820	630	135	2.25
4	3600	2600	2400	1800	1700	1100	135	2.25
5	8100	4500	5400	3000	3900	2200	180	2.25
6	11800	6000	7900	4000	5800	2900	225	2.25
7	18200	7900	12100	5300	8800	3800	225	2.25
8	27300	10800	18200	7200	12800	5100	450	4.5
9	36400	13500	24300	9000	17100	6300	450	4.5
10	48200	16600	32300	11200	22800	7900	450	4.5

(8) In the case of aerodrome fire-fighting Categories 1 and 2, up to one hundred percent of water may be replaced by a complementary agent.

(9) At aerodromes where operations by aeroplanes larger than the average size in a given category are planned, the quantities of water shall be recalculated and the amount of water for foam production and the discharge rates for foam solution shall be increased accordingly.

(10) The quantity of foam concentrates separately provided on vehicles for foam production shall be in proportion to the quantity of water provided and the foam concentrate selected.

(11) The amount of foam concentrate provided on a vehicle shall be sufficient to produce not less than two loads of foam solution.

(12) Supplementary water supplies shall be provided for the expeditious replenishment of rescue and fire-fighting vehicles at the scene of an aircraft accident.

(13) Where a combination of different performance level foams are provided at an aerodrome, the total amount of water to be provided for foam production shall be calculated for each type of foam and the distribution of these quantities shall be documented for each vehicle and applied to the overall rescue and fire-fighting equipment.

(14) The complementary agents shall comply with the appropriate specifications of the International Organisation for Standardisation (ISO 7202-Powder).

(15) The discharge rate of the foam solution and of complementary agents shall not be less than the values set out in table 17.

(16) The discharge rate of complementary agents shall not be less than the values set out in table 17.

(17) Where a complementary agent is expected to be used, dry chemical powders shall only be substituted with an agent that has equivalent or better fire-fighting capabilities for all types of fires.

(18) This regulation applies to aerodromes in Category A.

(19) The authority may where it considers it necessary apply this regulation to aerodromes in Category B.

## **250. Provision of reserve supplies of water and foam for fire-fighting vehicles**

(1) A reserve supply of foam concentrate, equivalent to 200 percent of the quantities set out in table 17, shall be maintained on the aerodrome for vehicle replenishment purposes and the foam concentrate carried on fire vehicles in excess of the quantities set out in table 17, shall be considered to contribute to the reserve.

(2) A reserve supply of a complementary agent, equivalent to 100 percent of the quantity set out in table 17, shall be maintained on the aerodrome for vehicle replenishment purposes and sufficient propellant gas shall be included to utilize this reserve complementary agent.

(3) Category 1 and 2 aerodromes that have replaced up to 100 percent of the water with complementary agent shall hold a reserve supply of the complementary agent of 200 percent.

(4) Where a major delay in the replenishment of the supplies is anticipated, the amount of reserve supply required under subregulations (1), (2) and (3) shall be increased as determined by a risk assessment exercise.

## **251. Provision of rescue equipment**

An aerodrome operator shall provide rescue equipment commensurate with the level of aircraft operations on the rescue and fire-fighting vehicle.

## **252. Response time for rescue and fire-fighting services**

(1) The operational objective of the rescue and fire-fighting service shall be to achieve a response time not exceeding three minutes to any point of every operational runway in optimum visibility and surface conditions.

(2) The operational objective of the rescue and fire-fighting service for aeroplanes shall be to achieve a response time not exceeding three minutes to any other part of the movement area in optimum visibility and surface conditions.

(3) The rescue and fire-fighting service for helicopters shall be to achieve response time not exceeding two minutes in optimum conditions of visibility and surface conditions.

- (4) (a) For the purpose of this regulation, response time means the time between the initial call to the rescue and fire-fighting service, and the time when the first responding vehicle is in position to apply foam at a rate of not less than 50 percent of the discharge rate specified in table 17; and
- (b) optimum visibility and surface conditions means daytime, good visibility, no precipitation with normal response route free of surface contamination including water.

(5) The aerodrome operator shall set up procedures for frequent testing of rescue and fire-fighting response times in a variety of scenarios appropriate to the aerodrome operation, and keep records of such tests.

(6) An aerodrome operator shall provide suitable guidance, equipment or procedures for rescue and fire-fighting services to meet the operational objectives in less than optimum conditions of visibility, especially during low visibility operations.

(7) Any vehicles, other than the first responding vehicle, required to deliver the amounts of extinguishing agents specified in Table 17 shall provide continuous agent application and shall arrive within four minutes from the initial call.

(8) A system of preventive maintenance of rescue and fire-fighting vehicles shall be employed to facilitate the effectiveness of the equipment and compliance with the specified response time throughout the life of the vehicle.

### **253. Establishment of emergency access roads**

(1) Emergency access roads shall be provided on an aerodrome where terrain conditions permit their construction to facilitate the achievement of the minimum response times.

(2) Particular attention shall be given to the provision of ready access to approach areas up to 1,000m from the threshold or at least within the aerodrome boundary and where a fence is provided, the need for convenient access to areas outside the fence shall be taken into account.

(3) The aerodrome service roads may serve as emergency access roads where they are suitably located and constructed.

(4) The emergency access roads shall be capable of supporting the heaviest vehicles which will use them, and shall be usable in all weather conditions.

(5) All roads within 90m of a runway shall be surfaced to prevent surface erosion and the transfer of debris to the runway.

(6) Sufficient vertical clearance shall be provided from overhead obstructions for the largest vehicles.

(7) Where the surface of the road cannot be distinguished from the surrounding area, edge markers shall be placed at intervals of about 10m.

### **254. Rescue and fire-fighting service stations**

(1) All rescue and fighting vehicles shall be housed in a fire station.

(2) Satellite fire stations shall be provided where the response time cannot be achieved from a single fire station.

(3) The fire station shall be located so that the access for rescue and fire-fighting vehicles into the runway area is direct and clear, requiring a minimum number of turns.



**255. Provision of communication and alerting systems for rescue and fire-fighting services**

(1) An aerodrome operator shall provide a discrete communication system linking a fire station with the control tower, any other fire station on the aerodrome and the rescue and fire-fighting vehicles.

(2) An aerodrome operator shall provide communication system between crew members on each rescue and fire-fighting vehicle.

(3) An aerodrome operator shall provide direct communication system between the rescue and fire-fighting service and the flight crew of an aircraft on the ground in case of an emergency.

(4) An alerting system for rescue and fire-fighting personnel, capable of being operated from that station, shall be provided at the fire station, any other fire station on the aerodrome and at the aerodrome control tower.

**256. Minimum number of rescue and fire-fighting vehicles**

The minimum number of rescue and fire-fighting vehicles provided at an aerodrome shall be in accordance with the Table 18.

**Table 18- Minimum number of rescue and fire-fighting vehicle**

<i>Aerodrome fire category</i>	<i>Number of rescue and fire-fighting vehicles</i>
1	1
2	1
3	1
4	1
5	1
6	2
7	2
8	3
9	3
10	3

## **257. Requirements for rescue and fire-fighting personnel**

(1) An aerodrome operator shall carry out a task resource analysis to determine the minimum number of rescue and fire-fighting personnel required at the aerodrome, and shall document in the Aerodrome Manual, the level of staffing.

(2) An aerodrome operator shall ensure that all rescue and fire-fighting personnel are properly trained to perform their duties in an efficient manner, and shall participate in live fire drills commensurate with the types of aircraft and type of rescue and fire-fighting equipment in use at the aerodrome, including pressure-fed fuel fires.

(3) An aerodrome operator shall establish and implement a training programme for rescue and fire-fighting personnel. The training programme shall include training in fire dynamics, toxicity and basic first aid, extinguishing agents, their application, and fire-fighting techniques used at the aerodrome; handling of vehicles, vessels and equipment used at the aerodrome, including building RFF equipment; aerodrome layout; construction and layout of aircraft types that regularly use the aerodrome, and emergency aircraft evacuation assistance; operational tactics and manoeuvres; emergency communication and log keeping; leadership performance; physical fitness; handling of dangerous goods emergencies; rescue on water; response to public health emergencies; RFF personnel safety.

(4) The rescue and fire-fighting personnel training programme shall include training in human performance, including team coordination.

(5) During flight operations, sufficient trained and competent personnel shall be designated to be readily available to ride the rescue and fire-fighting vehicles and to operate the equipment at maximum capacity.

(6) The rescue and fire-fighting personnel shall be deployed in a way that ensures that minimum response times can be achieved and that continuous agent application at the appropriate rate can be fully

maintained, taking into account, the need for the personnel to use hand lines, ladders and other rescue and fire-fighting equipment normally associated with aircraft rescue and fire-fighting operations.

(7) All responding rescue and fire-fighting personnel shall be provided with protective clothing and respiratory equipment to enable them perform their duties in an effective manner.

(8) In this regulation, “pressure-fed fires” means fires associated with fuel discharge under very high pressure from a ruptured fuel tank.

**258. Removal of disabled aircraft**

(1) An aerodrome operator shall have in place a plan for the removal of an aircraft disabled on, or adjacent to, the movement area and shall designate a coordinator to implement the plan where necessary.

(2) The disabled aircraft removal plan shall be based on the characteristics of the aircraft that are expected to operate at the aerodrome and, the plan shall include—

- (a) a list of equipment and personnel on or in the vicinity of, the aerodrome which would be available for such purpose;
- (b) arrangement for the rapid receipt of aircraft recovery equipment kits from other aerodromes, where applicable; and
- (c) the name and contacts of the co-ordinator designated to implement the plan.

(3) The plan under this regulation shall include particulars of the procedures for removing a disabled aircraft on the movement area or adjacent to it.

(4) This regulation shall not apply to aerodromes in Category C except where specified by the authority.

## **259. Apron management service**

(1) Where warranted by the volume of traffic and operating conditions, an appropriate apron management service shall be provided on an apron by an aerodrome air traffic services unit, by the aerodrome operating authority or by a cooperative combination of the services for the purposes of—

- (a) regulating movement with the objective of preventing collisions between aircraft, and between aircraft and obstacles;
- (b) regulating entry of aircraft into and coordinating exit of aircraft from, the apron with the aerodrome control tower; and
- (c) facilitating safe and expeditious movement of vehicles and appropriate regulation of other activities.

(2) Where the aerodrome control tower does not participate in the apron management service, procedures shall be established to facilitate the orderly transition of aircraft between the apron management unit and the aerodrome control tower.

(3) An aerodrome operator shall see to it that, radio telephony communication facilities are provided where an apron management service is established.

(4) Where low visibility procedures are in effect, persons and vehicles operating in the apron shall be restricted to the essential minimum.

(5) An emergency vehicle responding to an emergency shall have priority over all other surface movement traffic.

(6) A person who operates a vehicle on an apron shall give way to—

- (a) an emergency vehicle;

- (b) an aircraft taxiing, about to taxi, or being pushed or towed; and
- (c) other vehicles in accordance with the local aerodrome regulations.

(7) An aircraft stand shall be visually monitored so that the recommended clearance distances are provided to an aircraft using the stand.

(8) This regulation shall not apply to aerodromes in Category C except where otherwise specified by the authority.

## **260. Ground servicing of aircraft**

(1) An aerodrome operator shall see to it that fire extinguishing equipment, suitable for at least the initial intervention, in the event of a fuel fire, is readily available during the ground servicing of an aircraft and, that there is means of quickly summoning the rescue and fire-fighting services in the event of a fire or major fuel spill.

(2) An aerodrome operator shall see to it that, when aircraft refuelling operations take place while passengers are on board, embarking or disembarking, ground equipment is positioned in a manner that allows—

- (a) the use of a sufficient number of exits for expeditious evacuation; and
- (b) a ready escape route from each of the exits to be used in the case of an emergency.

## **261. Aerodrome vehicle operation**

(1) A person shall not operate a vehicle on the manoeuvring area at an aerodrome where air traffic service is provided, except when authorised by the aerodrome control tower.

(2) A person shall not operate a vehicle on an apron of an aerodrome except when authorised by the aerodrome operator.

(3) A vehicle operating on the movement area shall have a rotating beacon.

(4) A driver of the vehicle on the movement area shall comply with all mandatory instructions conveyed by markings and signs, when the vehicle is on the manoeuvring area, except where the driver is authorised by—

- (a) the aerodrome control tower when on the manoeuvring area; and
- (b) on an apron only as authorised by the appropriate designated authority.

(5) A driver of the vehicle on the movement area shall comply with all mandatory instructions conveyed by lights.

(6) A driver of a vehicle on the movement area shall comply with all mandatory instructions conveyed by lights and instructions issued by the aerodrome control tower where the vehicle is on the manoeuvring area or by the appropriate designated authority, where the vehicle is on an apron.

(7) A driver of a vehicle on the movement area shall be appropriately trained for the tasks to be performed and shall comply with the instructions issued by—

- (a) the aerodrome control tower, when on the manoeuvring area; and
- (b) the appropriate designated authority, when on the apron.

(8) A driver of a radio-equipped vehicle shall establish satisfactory two-way radio communication with the aerodrome control tower before entering the manoeuvring area and shall;

- (a) maintain a continuous listening watch on the assigned frequency while on the movement area; and

- (b) read back to the air traffic controller, safety related parts of instructions which are transmitted by voice including instructions to enter, hold short of cross and operate on any operational runway or taxiway.

(9) An aerodrome operator shall see to it that every driver operating a vehicle on an active runway, or within the graded area or runway end safety area of the runway, is trained, assessed as competent, and operates on the VHF tower radio frequency in use at the time by the tower controller and pilots, using correct radio terminology and techniques to avoid interfering with controller to pilot communications.

## **262. Surface movement guidance and control systems**

(1) A Surface Movement Guidance and Control System (SMGCS) shall be provided at every aerodrome.

(2) The design of the SMGCS provided that at an aerodrome shall take into account the—

- (a) density of air traffic;
- (b) visibility conditions under which operations are intended;
- (c) need for pilot orientation;
- (d) complexity of the aerodrome layout; and
- (e) movement of vehicles.

(3) The visual aid components of a SMGCS, shall be designed to conform to the relevant specifications in Part X of these Regulations.

(4) The SMGCS shall be designed to assist in the prevention of inadvertent incursions of aircraft and vehicles onto an active runway.

(5) The SMGCS shall be designed to assist in the prevention of collisions between aircraft, and between aircraft and vehicles or objects, on any part of the movement area.

(6) Where a SMGCS is provided by selective switching of stop bars and taxiway center line lights, the following requirements shall be met—

- (a) taxiway routes which are indicated by illuminated taxiway center line lights shall be capable of being terminated by an illuminated stop bar;
- (b) the control circuits shall be arranged so that when a stop bar located ahead of an aircraft is illuminated, the appropriate section of the taxiway center line lights beyond it is suppressed; and
- (c) the taxiway center line lights are activated ahead of an aircraft when the stop bar is suppressed.

(7) Surface movement radar for the manoeuvring area shall be provided at an aerodrome intended for use in runway visual range conditions less than a value of 350m.

(8) Surface movement radar for the manoeuvring area shall be provided at an aerodrome other than that in subregulation (7) when traffic density and operating conditions are such that regularity of traffic flow cannot be maintained by alternative procedures and facilities.

### **263. Siting of equipment and installations on operational areas**

(1) Unless its function requires it to be there for air navigation or for aircraft safety purposes, no equipment or installation shall be—

- (a) on a runway strip, a runway end safety area, a taxiway strip or within the distances specified in table 2, column 11, if it would endanger an aircraft; or
- (b) on a clearway if it would endanger an aircraft in the air.

(2) Any equipment or installation required for air navigation or for aircraft safety purposes shall be located—



- (a) on that portion of a runway strip within—
  - (i) 75m of the runway center line where the code number is 3 or 4; or
  - (ii) 45m of the runway center line where the code number is 1 or 2;
- (b) on a runway end safety area, a taxiway strip or within the distances specified in table 2; or
- (c) on a clearway;

and which would endanger an aircraft in the air shall be frangible and mounted as low as possible.

(3) Any equipment or installation required for air navigation or for aircraft safety purposes which shall be located on the non-graded portion of a runway strip shall be regarded as an obstacle and shall be frangible and mounted as low as possible.

(4) Unless its function requires it to be there for air navigation or for aircraft safety purposes, equipment or installation shall not be located within 240m from the end of the strip and within—

- (a) 60m of the extended center line where the code number is 3 or 4; or
- (b) 45 m of the extended center line where the code number is 1 or 2;

of a precision approach runway Category I, II or III.

(5) Any equipment or installation required for air navigation or for aircraft safety purposes which shall be located on or near a strip of a precision approach runway Category I, II or III and which—

- (a) is situated within 240m from the end of the strip and within—
  - (i) 60m of the extended runway center line where the code number is 3 or 4; or

(ii) 45m of the extended runway center line where the code number is 1 or 2; or

(b) penetrates the inner approach surface, the inner transitional surface or the balked landing surface;

shall be frangible and mounted as low as possible.

(6) Any equipment or installation required for air navigation or for aircraft safety purposes which is an obstacle of operational significance shall be frangible and mounted as low as possible.

(7) Any equipment or installation installed within the graded area of a runway strip or within the runway end safety area shall be de-lethalised to prevent the wheel of an aeroplane, from sinking into the ground, from striking a hard vertical face either by chamfering from the top of the construction to not less than 30cm below the strip surface level, or by being buried to a depth of not less than 30cm.

(8) Any equipment or installation installed within a runway strip or within the runway end safety area shall; be marked and lit in accordance with regulation 226 and 227 of these Regulations

## **264. Fencing of aerodromes and installations**

(1) An aerodrome operator shall provide a fence or a suitable barrier on the aerodrome—

(a) to prevent the entrance into the movement area, by any animal likely to be a hazard to aircraft; and

(b) to deter the inadvertent or premeditated access of an unauthorised person onto a non-public areas of the aerodrome.

(2) An aerodrome operator shall provide suitable means of protection for an aerodrome to deter the inadvertent or premeditated access of unauthorised persons into ground installations and facilities essential for the safe operation of aircraft.

(3) The fence or barrier required under subregulation (1) shall be located in such away that separates the movement area and other facilities or zones on the aerodrome which are vital to the safe operation of aircraft, from areas open to public use.

(4) Where greater security is needed, a cleared area shall be provided on both sides of the fence or barrier referred to in subregulation (1), to facilitate the work of patrols and to make trespassing more difficult.

(5) Provision for a perimeter road along the aerodrome fencing for the use of both maintenance personnel and security patrols may be made.

(6) Where the authority considers it necessary for security reasons, a fence or other barrier provided for the protection of international civil aviation and its facilities shall be illuminated at a minimum essential level and the security lighting shall be located in such a way that the ground area on both sides of the fence or barrier, particularly at access points, is illuminated.

## **265. Maintenance of safety inspection programme**

(1) An aerodrome operator shall establish and maintain a safety inspection programme for the aerodrome.

(2) The safety inspection programme shall—

(a) provide procedures for its effective execution by competent aerodrome personnel; and

(b) provide a reporting system for the prompt correction of unsafe aerodrome conditions noted during any inspection.

## **266. Maintenance of fire prevention programme**

(1) An aerodrome operator shall establish a fire prevention programme with preventive measures against possible fires on the aerodrome and engage a person to maintain the fire prevention programme for the aerodrome and the aerodrome buildings.

(2) Where an aerodrome does not have a designated fire service, the aerodrome operator shall arrange with the relevant local government authority or any other concerned authority to maintain a fire prevention programme for the aerodrome and to advise the aerodrome operator of any dangerous conditions for rectification.

(3) An aerodrome operator shall see to it that unsafe practices that may result in fire are not performed on the aerodrome or within its vicinity.

(4) Notwithstanding subregulation (3) where unsafe practices are performed during maintenance at the aerodrome, an aerodrome operator shall alert the rescue and fire-fighting services concerned, to be on standby for the duration of the practices.

**267. Access of ground vehicles and personnel to aerodrome movement area**

(1) An aerodrome operator shall—

(a) limit the access of any ground vehicles used for aerodrome and aircraft operations, to the aerodrome manoeuvring area;

(b) provide adequate procedures for the safe and orderly access to the aerodrome and operations in the manoeuvring area of ground vehicles, where an air traffic service unit is in operation at the aerodrome, such that each ground vehicle operating in the aerodrome manoeuvring area is controlled by—

(i) two-way radio communication between the ground vehicle and the air traffic service unit; or

(ii) an accompanying radio communication or an escort vehicle with adequate measures including signals or guards to control the vehicle, where the vehicle does not have a radio;

- (c) provide adequate measures to ensure that ground vehicles operating in the aerodrome movement area are controlled by signs, pre-arranged signals or standards prescribed by the authority, where an air traffic service unit is not in operation at the aerodrome; and
- (d) see to it that any person who operates a ground vehicle on the aerodrome movement area is familiar with and complies with the rules and procedures for the operation of ground vehicles prescribed by the authority.

(2) An aerodrome operator shall see to it that a person who has access to the aerodrome movement area wears a coloured reflective gear which shall be conspicuously displayed while on the movement area.

(3) In this regulation, “gear” includes a vest, band, overcoat, helmet and socks.

## **268. Operation of aircraft exceeding certified characteristics of aerodrome**

(1) An aerodrome operator shall not accommodate an aircraft that exceeds the certified characteristics of the aerodrome unless prior approval is granted by the authority.

(2) Where an aerodrome intends to accommodate an aeroplane that exceeds the certificated characteristics of the aerodrome, a compatibility study between the operation of the aeroplane and aerodrome infrastructure and operations shall be assessed and appropriate measures developed and implemented for the purpose of maintaining an acceptable level of safety during operations.

(3) An aerodrome operator shall carry out a compatibility study in collaboration with stakeholders including aircraft operator, Air Navigation Service providers and ground handling agencies.

(4) The alternative measures, operational procedures and operating restrictions developed under subregulation (1) shall be submitted to the authority prior to implementation.

(5) The alternative measures, operational procedures and operating restrictions implemented at an aerodrome referred to in subregulation (2) shall be included in the aerodrome manual and shall be reviewed periodically by the aerodrome operator, for purposes of assessing their validity and compliance with these Regulations and shall be published in the Aeronautical Information Publication.

## **269. Autonomous runway incursion warning system**

(1) Where an Autonomous Runway Incursion Warning System (ARIWS) is installed at an aerodrome—

- (a) it shall provide autonomous detection of a potential incursion or of the occupancy of an active runway and a direct warning to a flight crew or vehicle operator;
- (b) it shall function and be controlled independently of any other visual system on the aerodrome;
- (c) its visual aid components, i.e. lights, shall be designed to conform with the specifications in Part X of these Regulations; and
- (d) failure of part or all of the ARIWS shall not interfere with normal aerodrome operations and provision shall be made to allow the Air Traffic Control unit to partially or entirely shut down the system.

(2) The ARIWS shall be operational under all weather conditions, including conditions of low visibility.

(3) Where an ARIWS is installed at an aerodrome, information on its characteristics and status shall be provided to the Aeronautical Information Services for promulgation in the Aeronautical Information Publication with the description of the aerodrome surface movement guidance and control system and markings as set out in the Civil Aviation (Aeronautical Information Services) Regulations 2022.

**270. Application of Part**

This Part applies to all aerodromes, except where the authority states otherwise.

**271. Wildlife hazard management**

(1) An aerodrome operator shall, in consultation with the authority responsible for wildlife, take necessary action to control wildlife hazards at the aerodrome.

(2) An aerodrome operator shall see to it that there is in place procedures to deal with the danger posed to aircraft operations by the presence of wildlife in the aerodrome flight pattern or movement.

(3) An aerodrome operator shall provide for the conduct of an ecological study, acceptable to the authority, where any of the following events occurs at or near the aerodrome—

- (a) an air carrier aircraft experiences a multiple bird strike or engine ingestion;
- (b) an air carrier aircraft experiences a damaging collision with wildlife other than birds; or
- (c) wildlife of a size or in numbers capable of causing an event described in paragraph (a) or (b) is observed to have accessed an aerodrome flight pattern or movement area.

(4) The ecological study required under subregulation (3) shall contain the following—

- (a) an analysis of the event which prompted the study;
- (b) the identification of the species, numbers, locations, local movements, and daily and seasonal occurrences of the wildlife observed;

- (c) the identification and location of features on and near the aerodrome that attract wildlife; and
- (d) a description of the wildlife hazard to air carrier operations.

(5) The ecological study referred to in subregulation (3) shall be submitted to the authority, which shall then determine whether or not there is a need for a wildlife hazard management plan.

(6) In determining whether there is a need for a wildlife hazard management plan referred to in subregulation (5), the authority shall consider —

- (a) the ecological study;
- (b) the aeronautical activity at the airport;
- (c) the views of the certificate or licence holder;
- (d) the views of the airport users; and
- (e) any other factors bearing on a matter of which the authority is aware.

(7) Where the authority determines that a wildlife hazard management plan is needed, the aerodrome operator shall formulate and implement a plan using the ecological study as a basis.

- (8) The wildlife hazard management plan shall—
  - (a) be approved by the authority before its implementation; and
  - (b) provide measures to alleviate or eliminate wildlife hazards to aircraft operations.

- (9) The wildlife hazard management plan shall include the—
  - (a) names of the people authorised and responsible for its implementation;



- (b) priorities for the required habitat modification and changes in land use identified in the ecological study, with target dates for completion;
- (c) the resources for implementation of the plan;
- (d) procedures to be followed during the aircraft operations, including—
  - (i) assignment of responsibilities to personnel for implementing the procedures;
  - (ii) the conduct of physical inspections of the movement area and other areas critical to wildlife hazard management sufficiently in advance of the aircraft operations;
  - (iii) the wildlife control measures; and
  - (iv) communication between the wildlife control personnel and any air traffic control tower personnel in operation at the airport.
- (e) periodic evaluation and review of the wildlife hazard management plan for—
  - (i) effectiveness in dealing with the wildlife hazards; and
  - (ii) indications that the existence of the wildlife hazard, that is previously described in the ecological study, shall be re-evaluated; and
  - (f) a training program to provide aerodrome personnel with the knowledge and skills needed to carry out the wildlife hazard management plan.

(10) Notwithstanding the requirements of this regulation, each aerodrome operator shall take immediate measures to alleviate wildlife hazards whenever they are detected.

(11) Unless otherwise approved by the authority, whenever the requirements of this regulation cannot be met to the extent that uncorrected unsafe conditions exist on the airport, the aerodrome operator shall limit aircraft operations to those parts of the airport that are not rendered unsafe by the conditions.

(12) The aerodrome operator shall immediately notify the authority of any conditions which do not meet the standards prescribed in this regulation.

(13) The wildlife management plan of an aerodrome shall form part of the aerodrome manual and shall be approved by the authority.

## **272. Wildlife strike hazard reduction at aerodrome**

(1) A wildlife strike hazard on or in the vicinity of an aerodrome shall be assessed through—

- (a) the collection of information from aircraft operators, aerodrome personnel and other sources about the presence of wildlife on or around the aerodrome constituting a potential hazard to aircraft operations;
- (b) any ongoing evaluation of the wildlife hazard by competent personnel; and
- (c) the establishment of a national procedure for recording and reporting wildlife strikes to aircraft.

(2) The aerodrome operator shall collect and forward wildlife strike reports to the authority for submission to ICAO for inclusion in the ICAO Bird Strike Information System (IBIS) database.

(3) An aerodrome operator shall take action to decrease the risk to aircraft operations by adopting measures to minimize the likelihood of collisions between wildlife and aircraft.

(4) An aerodrome operator shall take action to eliminate or to prevent the establishment of refuse collection sites, garbage disposal dumps, including landfills, or any other source which may attract wildlife to the aerodrome, or its vicinity, unless where an appropriate

wildlife assessment indicates that they are unlikely to create conditions conducive to a wildlife hazard problem.

(5) Subject to subregulation (4), refuse collection sites, garbage disposal dumps and landfills shall not be located closer than a 15km radius circle centered on the aerodrome reference point and shall be located further, if located in the vicinity of an approach and take-off path of an aerodrome, except where studies of flight lines of birds attracted to these sites show that the birds will not be problematic for the aerodrome.

(6) Where the elimination of existing sites is not possible, the aerodrome operator and the relevant authorities shall see to it that any risk to aircraft posed by these sites is assessed and reduced to as low as reasonably practicable

(7) An aerodrome operator shall establish a local wildlife hazard management committee to manage wildlife hazards at the aerodrome.

(8) An aerodrome operator shall establish an aerodrome wildlife control unit, adequately equipped to control and manage wildlife hazard at the aerodrome

(9) The aerodrome operator shall cause records of all aspects of wildlife hazard control to be kept and shall report all wildlife strikes to the authority.

(10) An aerodrome operator shall monitor the local environment including any activities that may attract wildlife and in designing the wildlife hazard management plan, shall consider that environment and the activities that may attract wildlife.

(11) An aerodrome operator shall give due consideration to aviation safety concerns related to land developments in the vicinity of the aerodrome that may attract wildlife.

(12) An aerodrome operator shall see to it that all staff involved in wildlife control are trained, competent and equipped for detection and dispersal tasks.

**273. National committee on wildlife hazard management**

The director general of the authority may establish a national committee on wildlife hazard management.

**274. Responsibilities of national committee on wildlife hazard management**

Where established, the national committee on wildlife hazard management shall be responsible for—

- (a) analysing wildlife hazard problems at aerodromes;
- (b) carrying out research and development on wildlife hazard management;
- (c) acting as an interface between the aerodrome operators and air operators;
- (d) advising aerodrome operators on wildlife hazard management; and
- (e) reviewing the effectiveness of the wildlife hazard management programmes at aerodromes.

**275. Composition of national committee on wildlife hazard management**

Where established, the national committee on wildlife hazard management shall consist of—

- (a) the chief executive officer of the authority who shall be the chairperson;
- (b) representatives from the ministries responsible for civil aviation, local government and defence;
- (c) aerodrome operator representatives;

- (d) aircraft operator representatives;
- (e) chairpersons of the airports' local wildlife hazard management committees;
- (f) air navigation service provider representatives;
- (g) agencies responsible for wildlife services; and
- (h) such other persons or agencies as may be deemed necessary.

**276. Animals not allowed in restricted areas of aerodrome**

(1) A person shall not bring, permit or graze an animal in the restricted area of an aerodrome or cause any animal to graze or feed in the restricted area of an aerodrome.

(2) Subject to subregulation (1), a person who brings or permits an animal into the restricted area of an aerodrome or who receives an animal in the restricted area of the aerodrome, shall ensure that the animal is at all times under proper control while in the restricted area.

(3) In this regulation, “animal” means a domesticated animal or a bird.

PART XVI—AERODROME MAINTENANCE

**277. Maintenance programme**

(1) An aerodrome operator shall establish at the aerodrome, a maintenance programme, including preventive maintenance to maintain a facility in a condition that does not impair the safety, regularity and efficiency of air navigation.

(2) In this regulation—

- (a) “facility” includes a pavement, visual aid, fencing, drainage system, electrical systems and building; and
- (b) “preventive maintenance” means programmed maintenance work done to prevent failure or degradation of a facility.

(3) The design and application of the maintenance programme shall observe human factors principles.

**278. Maintenance of pavements and adjacent areas**

(1) The surfaces of all movement areas including pavements, runways, taxiways, aprons, and adjacent areas shall be inspected and their conditions monitored regularly as part of an aerodrome preventive and corrective maintenance programme for the purpose of avoiding and eliminating any foreign objects debris that might cause damage to aircraft or impair the operation of aircraft systems.

(2) The surface of the runway shall be maintained in a condition that precludes formation of harmful irregularities such as water pools and rough surfaces.

(3) A paved runway shall be maintained in a condition so as to provide surface friction characteristics at or above the minimum friction level set out in table 19, for the various continuous friction measuring equipment.

**Table 19: List of continuous friction measuring equipment and their recommended target friction levels**

Test equipment	Test Tyre		Test speed (Km/h)	Test water depth (mm)	Design Objective for new Surface	Main-tenance Planning Level (MPL)	Minimum Friction Level (MFL)
	Type	Pressure (kpa)					
(1)	(2)		(3)	(4)	(5)	(6)	(7)
Mu-meter Trailer	A	70	65	1.0	0.72	0.52	0.42
	A	70	95	1.0	0.66	0.38	0.26
Skiddometer Trailer	B	210	65	1.0	0.82	0.60	0.50
	B	210	95	1.0	0.74	0.47	0.34
Surface Friction Tester Vehicle	B	210	65	1.0	0.82	0.60	0.50
	B	210	95	1.0	0.74	0.47	0.34
Runway Friction Tester Vehicle	B	210	65	1.0	0.82	0.60	0.50
	B	210	95	1.0	0.74	0.54	0.41

TATRA Friction Tester Vehicle	B	210	65	1.0	0.76	0.57	0.48
	B	210	95	1.0	0.67	0.52	0.42
RUNAR Trailer	B	210	65	1.0	0.69	0.52	0.45
	B	210	95	1.0	0.63	0.42	0.32
Griptester Trailer	C	140	65	1.0	0.74	0.53	0.43
	C	140	95	1.0	0.64	0.36	0.24

(4) Runway surface friction characteristics for maintenance purposes shall be periodically measured with a continuous friction measuring device using self-wetting features and documented and that the frequency of these measurements are sufficient to determine the trend of the surface friction characteristics of the runway.

(5) Where runway surface friction measurements are made for maintenance purposes using a self-wetting continuous friction measuring device, the performance of the device shall meet the requirements set out in table 19 under subregulation (3).

(6) The personnel measuring runway surface friction required under subregulation (5) shall be trained to fulfil their duties.

(7) Corrective maintenance action shall be taken to prevent the runway surface friction characteristics for the entire runway or a portion of the runway from falling below the minimum friction level set out in subregulation (3).

(8) The aerodrome operator shall review the results of every runway friction assessment and where appropriate take the following action—

- (a) in the case the friction level is below the maintenance planning level, maintenance shall be arranged to restore the friction level, ideally to a value equal to or greater than the design objective for new surfaces;

- (b) in case the friction level indicates a falling trend, the aerodrome operator shall increase the frequency of the runway friction assessments for purposes of identifying any further or rapid deterioration and, where appropriate, take action;
- (c) in case the friction level is below the maintenance friction level, maintenance shall be arranged urgently in order to restore the friction level and, in accordance with regulation 74 (3), a NOTAM shall be issued advising aerodrome users, that the runway may be slippery when wet; and
- (d) in case the friction level is significantly below the maintenance friction level, the aerodrome operator shall consider withdrawing the runway from use for take-off and or landing when wet and issue a NOTAM in that respect.

(9) when a taxiway is used by turbine-engine aircraft, the surface of the taxiway shoulders shall be maintained so as to be free of any loose stones or other objects that may be ingested by the aeroplane engines.

(10) the design and maintenance of shoulders shall prevent the ingestion of stones or other objects by turbine engines.

(11) The runway surface shall be visually assessed, as necessary, under natural or simulated rain conditions for ponding or poor drainage and where required, corrective maintenance action taken.

### **279. Removal of contaminants.**

(1) Standing water, mud, dust, sand, oil, rubber deposits and other contaminants shall be removed from the surface of runways in use as quickly and thoroughly as possible to minimise their accumulation.

(2) Chemicals which may have harmful effects on aircraft or pavements or chemicals which may have toxic effects on the aerodrome environment, shall not be used.



## **280. Runway pavement overlays**

(1) An aerodrom operator shall see to it that the overlaying of runway pavements is done in accordance with the standards prescribed in these Regulations.

(2) The longitudinal slope of the temporary ramp, measured with reference to the existing runway surface or previous overlay course, shall be—

- (a) 0.5 to 1.0 percent of overlays up to and including 5cm in thickness; and
- (b) not more than 0.5 percent for overlays measuring more than 5cm in thickness.

(3) Overlaying shall proceed from one end of the runway toward the other end so that based on runway utilisation most aircraft operations will experience a down ramp.

(4) The entire width of the runway shall be overlaid during every work session.

(5) Before a runway being overlaid is returned to a temporary operational status, a runway center line marking conforming to the specifications in regulation 137 shall be made and in addition, the location of any temporary threshold shall be identified by a 3.6m wide transverse stripe.

(6) The frequency of these measurements shall be sufficient to determine the trend of the surface friction characteristics of the runway.

(7) An aerodrome operator shall see to it that, the overlay is constructed and maintained above the minimum friction level set out in table 19.

## **281. Maintenance of visual aids**

(1) An aerodrome operator shall not operate an aerodrome unless a system of preventive maintenance of visual aids is employed at the aerodrome.

(2) The system of preventive maintenance of visual aids to be employed shall confirm the lighting and marking system reliability.

(3) A light shall be deemed to be unserviceable when its main beam average intensity is less than 50 percent of the value specified in the respective figure in Schedule 4 to these Regulations.

(4) For light units where the designed main beam average intensity is above the value set out in Schedule 4 to these Regulations, the 50 percent value shall be related to that design value.

(5) The system of preventive maintenance employed for a precision approach runway Category II or III shall include the following checks—

- (a) visual inspection and in-field measurement of the intensity, beam spread and orientation of lights included in the approach and runway lighting systems;
- (b) control and measurement of the electrical characteristics of each circuitry included in the approach and runway lighting systems; and
- (c) control of the correct functioning of light intensity settings used by air traffic control.

(6) The in-field measurements of intensity, beam spread and orientation of lights included in approach and runway lighting systems for a precision approach runway Category II or III shall be undertaken by measuring all lights, as far as practicable, to verify conformance with the applicable specifications set out in Schedule 4 to these Regulations.

(7) Measurement of intensity, beam spread and orientation of lights included in approach and runway lighting systems for a precision approach runway category II or III shall be undertaken using a mobile measuring unit of sufficient accuracy to analyse the characteristics of the individual lights.

(8) The frequency of measurement of lights for precision approach runways Categories II or III shall be based on traffic density, the local pollution level, the reliability of installed lighting equipment and the continuous assessment of the result of the in-field measurements but, in any event, shall not be less than twice a year for in-pavement lights and not less than once a year for other lights.

(9) The system of preventive maintenance employed for a precision approach runway Category II or III shall have as its objective that, during any period of Category II or III operations, all approach and runway lights are serviceable and that, in any event, not less than—

- (a) 95 percent of the lights are serviceable in each of the following particular significant elements—
  - (i) precision approach Category II and III lighting system, the inner 450m;
  - (ii) runway center line lights;
  - (iii) runway threshold lights; and
  - (iv) runway edge lights;
- (b) 90 percent of the lights are serviceable in the touchdown zone lights;
- (c) 85 percent of the lights are serviceable in the approach lighting system beyond 450m; and
- (d) 75 percent of the lights are serviceable in the runway end lights.

(10) For the purpose of providing continuity of guidance, the allowable percentage of unserviceable lights shall not be permitted in such a way as to alter the basic pattern of the lighting system.

(11) An aerodrome operator shall not permit an unserviceable light to be adjacent to another unserviceable light, except in a barrette or a crossbar where two adjacent unserviceable lights may be permitted.

(12) In the case of barrettes, crossbars and runway edge lights, lights shall be considered to be adjacent if located consecutively and—

- (a) laterally- in the same barrette or crossbar; or
- (b) longitudinally- in the same row of edge lights or barrettes.

(13) The system of preventive maintenance employed for a stop bar provided at a runway-holding position used in conjunction with a runway intended for operations in runway visual range conditions less than a value of 350m shall have the following objectives—

- (a) no more than two lights will remain unserviceable; and
- (b) two adjacent lights will not remain unserviceable unless the light spacing is significantly less than that specified.

(14) The system of preventive maintenance employed for a taxiway intended for use in runway visual range conditions less than a value of 350m shall have as its objective that no two adjacent taxiway center line lights are unserviceable.

(15) The system of preventive maintenance employed for a precision approach runway category I shall have as its objective that, during any period of category I operations, all approach and runway lights are serviceable and that, in any event, at not less than 85 percent of the lights are serviceable in each of the following—

- (a) precision approach Category I lighting system;
- (b) runway threshold lights;

- (c) runway edge lights; and
- (d) runway end lights.

(16) In order to provide continuity of guidance an unserviceable light shall not be adjacent to another unserviceable light unless the light spacing is significantly less than that specified.

(17) The system of preventive maintenance employed for a runway meant for take-off in runway visual range conditions less than a value of 550m shall have as its objective that, during any period of operations, all runway lights are serviceable and that in any event —

- (a) not less than 95 percent of the lights are serviceable in the runway center line lights where provided and in the runway edge lights; and
- (b) not less than 75 percent of the lights are serviceable in the runway end lights.

(18) For the purposes of providing continuity of guidance, an unserviceable light shall not be adjacent to another unserviceable light.

(19) The system of preventive maintenance employed for a runway meant for take-off in runway visual range conditions of a value of 550m or greater shall have as its objective that, during any period of operations, all runway lights are serviceable and that, in any event, not less than 85 percent of the lights are serviceable in the runway edge lights and runway end lights and for the purposes of providing continuity of guidance, an unserviceable light shall not be adjacent to another unserviceable light.

## **282. Construction or maintenance activity during low visibility operations**

An aerodrome operator shall see to it that any construction or maintenance activity is not undertaken in the proximity of aerodrome electrical systems at any time during periods of low visibility operations.

### **283. Works at aerodromes**

(1) An aerodrome operator shall establish procedures and precautions such that any works carried out at an aerodrome do not endanger the safety of any aircraft operations.

(2) An aerodrome operator shall not commence any major aerodrome works or effect changes to the physical characteristics the aerodrome, without the approval of the authority.

(3) The aerodrome operator shall establish a Method of Work Plan (MOWP) before commencing any construction work on the aerodrome, unless the aerodrome is to be closed.

(4) The request for approval of the aerodrome works shall be accompanied with—

- (a) relevant safety procedures
- (b) aerodrome operating procedures during the works
- (c) designs or plans and diagrams

(5) The aerodrome operator shall see to it that the procedures and precautions referred to in subregulation (1) conform to the guidelines prescribed by the authority.

## **PART XVII— EXEMPTIONS**

### **284. Application for exemption**

(1) The authority may in writing, exempt, an aerodrome operator from complying with a specific provision of these Regulations.

(2) An application for an exemption from a provision of these Regulations shall be submitted in not less than sixty days before the effective date of exemption.

(3) An aerodrome operator shall make an application for exemption in writing and the application shall contain —

- (a) the name of aerodrome and the address of the aerodrome operator;
- (b) the specific requirement from which the applicant seeks exemption;
- (c) the justification for the exemption;
- (d) an aeronautical study report;
- (e) a description of the type of operations to be conducted under the proposed exemption;
- (f) the proposed duration of the exemption;
- (g) a detailed description of the alternative means by which the applicant is to observe a level of safety equivalent to that established by the regulation from which the exemption is applied for;
- (h) a review of any known safety concerns related to the required exemption, including information about any relevant accidents or incidents of which the applicant is aware; and
- (i) any other relevant information that may be required by the authority.

(4) Other than existing aerodrome facilities and equipment that are allowed to continue to remain in use, or exemptions granted to the aerodrome operator for specific cases of consideration, an aerodrome operator shall comply with these Regulations when introducing a new aerodrome facility or equipment, or when carrying out replacement or improvement works on an existing facility or equipment, unless the replacement or improvement works is limited to those of very minor nature.

### **285. Initial review by authority**

(1) The authority shall review an application for exemption for accuracy and compliance with the requirements of these Regulations.

(2) Where the applicant does not meet the requirements set out in regulation 284, the authority shall inform the applicant and no further action shall be taken on that application.

### **286. Evaluation of application for exemption**

(1) The authority shall conduct an evaluation of an application after the initial review in accordance with regulation 285, to determine whether—

- (a) the proposal by the applicant provides a level of safety equivalent to that established by the regulation from which the exemption is sought; and
- (b) a grant of the exemption would contravene the applicable standards.

(2) The authority shall inform the applicant in writing and publish a detailed report of its evaluation and decision to grant or deny the application for exemption.

(3) The report referred to in subregulation (2) shall specify the duration of the exemption and any conditions or limitations of the exemption.

### **287. Grant or refusal of an exemption**

(1) Where the aerodrome operator meets the requirements and criteria set for grant of exemption, the authority shall grant an exemption for a specified period.

(2) The authority may refuse to grant an exemption where in the opinion of the authority—

- (a) the reasons given for the exemption are not satisfactory;
- (b) the exemption will adversely affect safety;
- (c) the exemption will not be in the public interest; and



- (d) where applicable, will not provide the level of safety to equal to that intended by these regulations.

(3) Exemptions granted to an aerodrome operator shall be recorded in the aerodrome manual. The aerodrome manual shall contain details of the exemption, reason that the exemption was requested for, any resultant limitations, conditions or procedures imposed, and other related safety information.

(4) An exemption granted in respect of an existing facility shall continue to apply until its expiry date.

### **288. Control or review of exemptions**

Upon the grant or refusal of an exemption the authority shall carry out continuous review of the exemption.

## PART XVIII— GENERAL PROVISIONS

### **289. Change of name of licence or certificate holder**

(1) A holder of an approved licence or certificate may apply to the authority to change the name of the holder of the licence or certificate.

(2) An application in subregulation (1) shall be accompanied by—

- (a) the current licence or certificate; and
- (b) a court order or any other legal document verifying the change of name, if any.

(3) The authority shall change the name of the holder and issue a replacement licence or certificate with the appropriate endorsement.

(4) The authority shall retain copies of the documents submitted under subregulation (2).

**290. Change of address by licence or certificate holder**

(1) A holder of a licence or certificate, shall inform the authority of—

- (a) change in the physical address not less than fourteen days in advance; and
- (b) his or her new mailing address.

(2) Where a holder of an approved licence or certificate does not inform the authority of the change in the physical address within the time specified in subregulation (1), the authority may suspend the licence or certificate.

**291. Use and retention of licences, certificates, approvals and records**

(1) A person shall not —

- (a) use a licence, certificate, approval, permission, exemption or any other document issued or required by or under these Regulations which is forged, altered, revoked, or suspended, or which the person is not entitled to use;
- (b) forge or alter a licence, certificate, approval, permission, exemption or any other document issued or required by or under these Regulations;
- (c) lend a licence, certificate, approval, permission, exemption or any other document issued or required by or under these Regulations to any other person; or
- (d) make any false representation for the purpose of procuring for himself, herself or any other person the issue, renewal or variation of a licence, certificate, approval, permission or exemption or other document.

(2) A person shall not, during the period for which it is required under these Regulations to be preserved—

- (a) mutilate, alter, render illegible or destroy a licence or certificate or any entry made in any record;

- (b) make, procure or assist in the making of any false entry in a licence, certificate or record; or
- (c) omit to make a material entry in a licence or certificate or record.

(3) A record required to be maintained under these Regulations shall be in permanent and indelible material.

(4) A person shall not purport to issue a licence, certificate, approval or exemption for the purpose of these Regulations unless that person is authorised to do so.

(5) The authority may suspend or cancel a licence, certificate or approval of an operator who contravenes any provision of these Regulations.

## **292. Replacement of documents**

A holder of a licence, certificate or approval who requires a replacement of the licence or certificate may apply to the authority in the prescribed form.

## **293. Aeronautical user charges**

(1) The authority shall notify the fees to be charged in respect of—

- (a) the issue, validation, renewal, extension or variation of any licence, certificate, approval or any other document, including a copy of any of these;
- (b) the undertaking of any examination, test, inspection or investigation; or
- (c) the grant of any permission or approval required for the purposes of these Regulations.

(2) Where an application for which any fee is chargeable under subregulation (1) is made, the applicant shall, before the application is processed, pay the required fee.

(3) The authority shall not refund the fees where an application is withdrawn after payment of fees is made or where the application ceases to have effect or is rejected.

#### **294. Conditions for operating an aerodrome**

(1) A person shall not operate an aerodrome or licensed, certificated under these Regulations unless the facilities and characteristics of the aerodrome are effectively related and match the needs of the aircraft for which the aerodrome is intended.

(2) The authority may close an aerodrome where the authority establishes that an aerodrome operator—

- (a) is incapable or unwilling to carry out corrective action or has repeatedly committed serious violations;
- (b) has demonstrated a lack of responsibility, such as deliberate and flagrant acts of non-compliance or falsification of records jeopardising aviation safety; or
- (c) has made it convincingly clear that the continued operation of the aerodrome will be detrimental to the public interest.

#### **295. Lighting of en-route obstacles**

(1) An owner or a person in charge of an en-route obstacle shall ensure that the en-route obstacle is fitted with medium intensity steady red light—

- (a) positioned as close as possible to the top of the obstacle; and
- (b) spaced as far as practicable, equally between the top lights and ground level with an interval not exceeding thirty three meters, at the intermediate levels.

(2) Where any light which is required under this regulation to be displayed fails to function, the owner or a person in charge of an en-route obstacle shall repair or replace the light as soon as is reasonably

practicable but in any case not later than twenty four hours after the disfunctioning of the light.

(3) Subject to subregulation (2), an owner or a person in charge of an en-route obstacle shall ensure that the lights required to be fitted by this regulation are displayed.

(4) An owner or a person in charge of an en-route obstacle shall ensure that sufficient light is fitted and arranged at each level of an obstacle where lights are required to be fitted, so as to show, when displayed, in all directions.

(5) The authority may direct that an en-route obstacle is fitted with additional lights which shall be displayed in such positions and at such times as the authority may specify.

(6) In this regulation —

- (a) “en-route obstacle” means any building, structure or erection, which is one hundred meters or more, above ground level, except a building, structure or erection, which is in the vicinity of an aerodrome; and
- (b) “medium intensity steady light” means a light, which complies with the characteristics described for a medium intensity type C light.

## **296. Land use in vicinity of aerodrome**

All land use practices and activities in the vicinity of an aerodrome shall conform to the guidelines prescribed by the authority.

## **297. Aeronautical study**

(1) Where an aerodrome does not meet the requirements of these regulations, the authority may determine, after the conduct of an aeronautical study, the conditions and procedures that are necessary to ensure a level of safety equivalent to that established by these Regulations.

(2) Subject to subregulation (1), the aerodrome operator shall conduct an aeronautical study, and submit the report to the authority for review.

### **298. Deviations from regulations**

Any deviation from these Regulations or prescribed practice and the conditions and procedures referred to in Regulation 15 and 31 shall be set out in an endorsement on the aerodrome manual and aerodrome certificate or licence.

### **299. Safety inspections and audits**

The authority shall—

- (a) carry out safety inspections and audits necessary for the purpose of verifying the validity of an application for construction and operation of an aerodrome; and
- (b) carry out safety inspections and audits of any document and records of an operator, which may be necessary to determine compliance with the appropriate requirements prescribed in these Regulations.

### **300. Obligation to insure aerodrome**

(1) A person shall not operate or cause or permit any other person to operate, an aerodrome unless there is a policy of insurance in force in relation to that aerodrome.

(2) A policy of insurance shall be of no effect for the purposes of subregulation (1) unless—

- (a) there has been issued by the insurer to the aerodrome operator a certificate in relation to the policy of insurance in such form and containing such particulars as the authority may prescribe; and
- (b) the aerodrome operator has sent or caused to be sent, to the authority a copy of certificate.

(3) Where the policy of insurance at any time or for any reason ceases to have effect, any licence or certificate issued under these Regulations in respect of the aerodrome to which the policy of insurance relates shall be considered as revoked.

(4) Where the policy of insurance has expired, a licence or certificate in relation to the operation of an aerodrome shall not be renewed or amended under these Regulations.

(5) In this regulation “policy of insurance” means a policy which insures the operator of an aerodrome against liability in respect of loss and damage caused to any person or property at that aerodrome and which complies with the conditions prescribed by the authority.

### **301. Acts prohibited on aerodrome**

(1) A person shall not—

- (a) obstruct or interfere with the proper use of the aerodrome;
- (b) obstruct any person executing his or her duties at the aerodrome;
- (c) remove or deface any notice, writing, document or marking erected or displayed by the aerodrome operator;
- (d) throw, leave or drop anything capable of causing injury to any person or damage to any property;
- (e) dump any waste matter except at a place approved for the purpose by the aerodrome operator; or
- (f) dump or spill any substance capable of causing water pollution, whether solid, liquid, vapour or gas or a combination of these, except at a place approved for that purpose by the aerodrome operator at an aerodrome.

(2) A person shall not, except with the permission of the aerodrome operator—

- (a) interfere or tamper with any part of the aerodrome or any equipment associated with the operation of the aerodrome;

- (b) climb any wall, fence, barrier, ceiling, gate or post on an aerodrome;
- (c) handle any baggage or carry baggage for a passenger at an aerodrome;
- (d) bring a vehicle into or drive into an aerodrome; or
- (e) obstruct an entrance to or a passage at an aerodrome in a manner that inconveniences other users of the entrance or passage.

## PART XIX—OFFENCES AND PENALTIES

### **302. Contravention of regulations**

A person who contravenes any provision of these Regulations may have his or her certificate, licence, approval, authorisation or such other document revoked or suspended by the authority.

### **303. Offences and penalties**

(1) A person who contravenes any provision of these Regulations, orders or notices made under these Regulations commits an offence and shall on conviction be liable to a fine not exceeding twenty four currency points or imprisonment to a term not exceeding twelve months or both, and in the case of a continuing contravention, each day of the contravention shall constitute a separate offence.

(2) Where it is proved that an act or omission of any person, which would otherwise have been a contravention by that person of a provision of these Regulations, orders or notices made under these Regulations was due to any cause not avoidable by the exercise of reasonable care by that person, the act or omission shall be considered not a contravention by that person of that provision.

## PART XX—SAVINGS AND TRANSITION

### **304. Revocation of S.I. No. 17 of 2019**

The Civil Aviation (Aerodromes) Regulations, 2019 are revoked.



### **305. Savings and transitional**

(1) A licence, certificate, approval or any other document issued to an operator prior to the commencement of these Regulations shall continue in force as if it was issued under these Regulations until it expires or is cancelled by the authority.

(2) Notwithstanding the continuance of any licence, certificate, authorisation, permit, exemptions or any other approval granted under subregulation (2), a person who at the commencement of these Regulations is carrying out any act, duty or operation affected by these Regulations shall, within six months from the commencement of these Regulations, or within such longer time as the Minister may by notice in the Gazette prescribe, comply with the requirements of these Regulations.

(3) Any person who fails to comply with subregulation (3), is liable to have a licence, certificate, authorisation, permit, exemption or any other approval cancelled in accordance with the provisions of these Regulations.

## SCHEDULE 1

*Regulation 65*

### **PARTICULARS TO BE INCLUDED IN AN AERODROME MANUAL FOR AERODROMES IN CATEGORY A, B AND C**

#### **A. AERODROMES IN CATEGORY A**

##### **1. PART I: GENERAL**

General information, including the following —

- (1) amendment record page;
- (2) Checklist of pages;
- (3) Contents;
- (4) purpose and scope of the aerodrome manual;
- (5) the legal requirement for a certificate and an aerodrome manual as prescribed in these Regulations ;
- (6) Staff to comply with the manual;
- (7) Distribution list;
- (8) Tracking and receipt of distribution;
- (9) Amendment procedure and circumstances;
- (10) Distribution procedures;
- (11) Planning/timing of distribution;
- (12) Submission of amendments to the authority;
- (13) Indication of amendments on pages;
- (14) Index;
- (15) References;
- (16) Definitions;
- (17) Abbreviations;

- (18) List of deviations authorised by the authority;
- (19) conditions for use of the aerodrome - a statement to indicate that the aerodrome shall at all times, when it is available for the take-off and landing of aircraft, be so available to all persons on equal terms and conditions;
- (20) the available aeronautical information system and procedures for its promulgation;
- (21) the system for recording aircraft movements; and
- (22) obligations of the aerodrome operator.

## 2. **PART 2: PARTICULARS OF THE AERODROME SITE**

General information, including the following—

- (1) a plan of the aerodrome showing the main aerodrome facilities for the operation of the aerodrome including, particularly, the location of each wind direction indicator;
- (2) a plan of the aerodrome showing the aerodrome boundaries;
- (3) a plan showing the distance of the aerodrome from the nearest city, town or other populous area, and the location of any aerodrome facilities and equipment outside the boundaries of the aerodrome; and
- (4) Particulars of the land title of the aerodrome site. If the boundaries of the aerodrome are not defined in the land title documents particulars of the land title to, or interest in, the property on which the aerodrome is located and a plan showing the boundaries and position of the aerodrome.

## 3. **PART 3: PARTICULARS OF THE AERODROME REQUIRED TO BE REPORTED TO THE AERONAUTICAL INFORMATION SERVICE**

The information included in this part, shall also be provide to aeronautical Information service, for promulgation in the Uganda Aeronautical information Publication; this includes —

- (1) Aerodrome location indicator and name

- (2) Aerodrome geographical and administrative data including—
- (a) aerodrome reference point, geographical coordinates in degrees, minutes and seconds, and its site;
  - (b) direction and distance of aerodrome reference point from centre of the city or town which the aerodrome serves;
  - (c) aerodrome elevation to the nearest foot, and reference temperature;
  - (d) where appropriate, geoid undulation at the aerodrome elevation position to the nearest foot;
  - (e) magnetic variation to the nearest degree, date of information and annual change;
  - (f) name of aerodrome operator, address, telephone and telefax numbers, e-mail address, AFS address and, if available, website address;
  - (g) types of traffic permitted to use the aerodrome (IFR/VFR); and remarks.
- (3) Operational hours, a detailed description of the hours of operation of services at the aerodrome, including —
- (a) aerodrome operator;
  - (b) customs and immigration;
  - (c) health and sanitation;
  - (d) AIS briefing office;
  - (e) ATS reporting office (ARO);
  - (f) MET briefing office;
  - (g) air traffic service;
  - (h) fuelling;
  - (i) handling;
  - (j) security; and remarks.

- (4) Handling services and facilities, a detailed description of the handling services and facilities available at the aerodrome, including—
  - (a) cargo-handling facilities;
  - (b) fuel and oil types;
  - (c) fuelling facilities and capacity;
  - (d) hangar space for visiting aircraft;
  - (e) repair facilities for visiting aircraft; and remarks.
  
- (5) Passenger facilities available at the aerodrome, provided as a brief description or a reference to other information sources such as a website including—
  - (a) hotel at or in the vicinity of aerodrome;
  - (b) restaurant at or in the vicinity of aerodrome;
  - (c) transportation possibilities;
  - (d) medical facilities;
  - (e) bank and post office at or in the vicinity of aerodrome;
  - (f) tourist office; and remarks.
  
- (6) Rescue and fire-fighting services, a detailed description of the rescue and fire-fighting services and equipment available at the aerodrome, including—
  - (a) aerodrome category for firefighting;
  - (b) rescue equipment;
  - (c) capability for removal of disabled aircraft; and remarks.
  
- (7) Seasonal availability — clearing, a detailed description of the equipment and operational priorities established for the clearance of aerodrome movement areas, including—
  - (a) type of clearing equipment;
  - (b) clearance priorities; and remarks.

- (8) Aprons, taxiways and check locations/positions data, details relating to the physical characteristics of aprons, taxiways and locations or positions of designated checkpoints, including—
- (a) designation, surface and strength of aprons;
  - (b) designation, width, surface and strength of taxiways;
  - (c) location and elevation to the nearest foot of altimeter checkpoints;
  - (d) location of VOR checkpoints;
  - (e) position of INS checkpoints in degrees, minutes, seconds and hundredths of seconds; and,

If check locations or positions are presented on an aerodrome chart, a note to that effect must be provided under this subsection.

- (9) Surface movement guidance and control system and markings, a brief description of the surface movement guidance and control system and runway and taxiway markings, including—
- (a) use of aircraft stand identification signs, taxiway guide lines and visual docking or parking guidance system at aircraft stands;
  - (b) runway and taxiway markings and lights;
  - (c) stop bars, if any; and remarks
- (10) Aerodrome obstacles, a detailed description of obstacles, including—
- (a) obstacles in Area 2—
    - (i) obstacle identification or designation;
    - (ii) type of obstacle;
    - (iii) obstacle position, represented by geographical coordinates in degrees, minutes, seconds and tenths of seconds;
    - (iv) obstacle elevation and height to the nearest foot;

- (v) obstacle marking, and type and colour of obstacle lighting, if any;
  - (vi) if appropriate, an indication that the list of obstacles is available in electronic form, and a reference to paragraph 4 (vi); and
  - (vii) NIL indication, if appropriate.
- (b) the absence of an Area 2 data set for the aerodrome is to be clearly stated and obstacle data are to be provided for—
- (i) obstacles that penetrate the obstacle limitation surfaces;
  - (ii) obstacles that penetrate the take-off flight path area obstacle identification surface; and
  - (iii) other obstacles assessed as being hazardous to air navigation.
- (c) indication that information on obstacles in Area 3 is not provided, or if provide—d
- (i) obstacle identification or designation;
  - (ii) otype of obstacle;
  - (iii) oobstacle position, represented by geographical coordinates in degrees, minutes, seconds and tenths of seconds;
  - (iv) oobstacle elevation and height to the nearest tenth of a foot;
  - (v) oobstacle marking, and type and colour of obstacle lighting, if any,;
  - (vi) oif appropriate, an indication that the list of obstacles is available in electronic form, and
  - (vii) oNIL indication, if appropriate.

- (11) Meteorological information provided, a detailed description of meteorological information provided at the aerodrome and an indication of which meteorological office is responsible for the service enumerated, including—
  - (a) name of the associated meteorological office;
  - (b) hours of service and, where applicable, the designation of the responsible meteorological office outside these hours;
  - (c) office responsible for preparation of TAFs and periods of validity and interval of issuance of the forecasts;
  - (d) availability of the trend forecasts for the aerodrome, and interval of issuance;
  - (e) information on how briefing or consultation is provided;
  - (f) types of flight documentation supplied and language used in flight documentation;
  - (g) charts and other information displayed or available for briefing or consultation;
  - (h) supplementary equipment available for providing information on meteorological conditions, such as weather radar and receiver for satellite images;
  - (i) the air traffic services unit provided with meteorological information; and
  - (j) additional information including concerning any limitation of service.
- (12) Runway physical characteristics, a detailed description of runway physical characteristics, for each runway, including —
  - (a) designations;
  - (b) true bearings to one-hundredth of a degree;
  - (c) dimensions of runways to the nearest foot;



- (d) strength of pavement (PCN and associated data) and surface of each runway and associated stopways;
  - (e) geographical coordinates in degrees, minutes, seconds and hundredths of seconds for each threshold and runway end and, where appropriate, geoid undulation of—
    - (i) thresholds of a non-precision approach runway to the nearest meter; and
    - (ii) thresholds of a precision approach runway to the nearest tenth of a meter;
  - (f) elevations of—
    - (i) thresholds of a non-precision approach runway to the nearest foot; and
    - (ii) thresholds and the highest elevation of the touchdown zone of a precision approach runway to the nearest tenth of a foot;
  - (g) slope of each runway and associated stopways;
  - (h) dimensions of stopway, if any, to the nearest meter;
  - (i) dimensions of clearway, if any, to the nearest meter;
  - (j) dimensions of strips;
  - (k) dimensions of runway end safety areas;
  - (l) location, which runway end, and description of arresting system, if any;
  - (m) the existence of an obstacle-free zone; and remarks.
- (13) Declared distances a detailed description of declared distances to the nearest meter for each direction of each runway, including—
- (a) runway designator;
  - (b) take-off run available;

- (c) take-off distance available, and if applicable, alternative reduced declared distances;
- (d) accelerate-stop distance available;
- (e) landing distance available; and
- (f) remarks, including runway entry or start point where alternative reduced declared distances have been declared, and

If a runway direction cannot be used for take-off or landing, or both, because it is operationally forbidden, then this must be declared and the words “not usable” or the abbreviation “NU” entered.

- (14) Approach and runway lighting, a detailed description of approach and runway lighting, including—
  - (a) runway designator;
  - (b) type, length and intensity of approach lighting system;
  - (c) runway threshold lights, colour and wing bars;
  - (d) type of visual approach slope indicator system;
  - (e) length of runway touchdown zone lights;
  - (f) length, spacing, colour and intensity of runway centre line lights;
  - (g) length, spacing, colour and intensity of runway edge lights;
  - (h) colour of runway end lights and wing bars; and
  - (i) length and colour of stopway lights.
- (15) Other lighting, secondary power supply, a description of other lighting and secondary power supply, including—
  - (a) location, characteristics and hours of operation of aerodrome beacon or identification beacon, if any;

- (b) location and lighting, if any, of anemometer or landing direction indicator;
  - (c) taxiway edge and taxiway centre line lights;
  - (d) secondary power supply including switch-over time; and remarks.
- (16) Helicopter landing area, a detailed description of helicopter landing area provided at the aerodrome, including—
- (a) geographical coordinates in degrees, minutes, seconds and hundredths of seconds and, where appropriate, geoid undulation of the geometric centre of Touchdown and Lift-Off (TLOF) or of each threshold of Final Approach and Take-Off (FATO) area—
    - (i) for non-precision approaches, to the nearest meter; and
    - (ii) for precision approaches, to the nearest tenth of a meter;
  - (b) TLOF or FATO area elevation—
    - (i) for non-precision approaches, to the nearest foot; and
    - (ii) for precision approaches, to the nearest tenth of a foot;
  - (c) TLOF and FATO area dimensions to the nearest meter, surface type, bearing strength and marking;
  - (d) true bearings to one-hundredth of a degree of FATO;
  - (e) declared distances available, to the nearest meter; and
  - (f) approach and FATO lighting.
- (17) Air traffic services airspace, a detailed description of air traffic services (ATS) airspace organised at the aerodrome, including—
- (a) airspace designation and geographical coordinates in degrees, minutes and seconds of the lateral limits;

- (b) vertical limits;
  - (c) airspace classification;
  - (d) call sign and language of the ATS unit providing service;
  - (e) transition altitude; and
  - (f) hours of applicability.
- (18) Air traffic services communication facilities, a detailed description of air traffic services communication facilities established at the aerodrome, including—
- (a) service designation;
  - (b) call sign;
  - (c) channel;
  - (d) SATVOICE number, if available;
  - (e) logon address, as appropriate; and
  - (f) hours of operation and remarks.
- (19) Radio navigation and landing aids, a detailed description of radio navigation and landing aids associated with the instrument approach and the terminal area procedures at the aerodrome, including—
- (a) type of aids, magnetic variation to the nearest degree, as appropriate, and type of supported operation for ILS, basic GNSS, SBAS, and GBAS and for VOR/ILS also station declination to the nearest degree used for technical line- up of the aid;
  - (b) identification, if required;
  - (c) frequency, channel number, service provider, and reference path identifier (RPI), as appropriate;
  - (d) hours of operation, as appropriate;

- (e) geographical coordinates in degrees, minutes, seconds and tenths of seconds of the position of the transmitting antenna, as appropriate;
- (f) elevation of the transmitting antenna of DME to the nearest 100 ft and of DME/P to the nearest 10 ft, elevation of GBAS reference point to the nearest foot, and the ellipsoid height of the point to the nearest foot. For SBAS, the ellipsoid height of the landing threshold point (LTP) or the fictitious threshold point (FTP) to the nearest foot; and
- (g) service volume radius from the GBAS reference point to the nearest kilometer or nautical mile and remarks

If the ground-based augmentation system (GBAS) serves more than one aerodrome, description of the aid must be provided under each aerodrome. If the operating authority of the facility is other than the designated governmental agency, the name of the operating authority must be indicated in the remarks column. Facility coverage must be indicated in the remarks column.

- (20) Local aerodrome regulations, a detailed description of regulations applicable to the use of the aerodrome including the acceptability of training flights, non-radio and microlight aircraft and similar, and to ground manoeuvring and parking but excluding flight procedures.
- (21) Noise abatement procedures, a detailed description of noise abatement procedures established at the aerodrome.
- (22) Flight procedures, a detailed description of the conditions and flight procedures, including radar or ADS-B procedures, established on the basis of airspace organisation at the aerodrome. When established, detailed description of the low visibility procedures at the aerodrome, including—
  - (a) runway and associated equipment authorised for use under low visibility procedures;

- (b) defined meteorological conditions under which initiation, use and termination of low visibility procedures would be made;
  - (c) description of ground marking or lighting for use under low visibility procedures; and remarks.
- (23) Additional information at the aerodrome, such as an indication of bird concentrations at the aerodrome, together with an indication of significant daily movement between resting and feeding areas, to the extent practicable.
- (24) The following Charts related to an aerodrome—
- (a) Aerodrome Chart;
  - (b) Aircraft Parking;
  - (c) Aerodrome Ground Movement Chart;
  - (d) Aerodrome Obstacle Chart — Type A (for each runway);
  - (e) Aerodrome Terrain and Obstacle Chart (Electronic);
  - (f) Precision Approach Terrain Chart (precision approach Cat II and III runways);
  - (g) Area Chart (departure and transit routes);
  - (h) Standard Departure Chart — Instrument;
  - (i) Area Chart (arrival and transit routes);
  - (j) Standard Arrival Chart — Instrument;
  - (k) ATC Surveillance Minimum Altitude Chart;
  - (l) Instrument Approach Chart (for each runway and procedure type);
  - (m) Visual Approach Chart; and
  - (n) bird concentrations in the vicinity of the aerodrome.

#### 4. **PART 4: PARTICULARS OF THE AERODROME OPERATING PROCEDURES AND SAFETY MEASURES**

##### (1) **Aerodrome data and reporting**

Particulars of the procedures for reporting any changes to the aerodrome information set out in the Aeronautical Information Publication and Aeronautical Information Circular and procedures for requesting the issue of NOTAMs, including the following—

- (a) arrangements for reporting any changes to the Authority and recording the reporting of changes during and outside the normal hours of aerodrome operations;
- (b) the names and roles of persons responsible for notifying the changes, and their telephone numbers during and outside the normal hours of aerodrome operations; and
- (c) the address and telephone and facsimile numbers, as provided by the Authority, of the place where changes are to be reported to the Authority.

##### (2) **Access to the aerodrome movement area**

Particulars of the procedures that have been developed and are to be followed in coordination with the agency responsible for preventing unlawful interference in civil aviation at the aerodrome and for preventing unauthorised entry of persons, vehicles, equipment, animals or other things into the movement area, including the following—

- (a) the role of the aerodrome operator, the aircraft operator, aerodrome fixed- base operator, the aerodrome security entity, the Authority and other government departments, as applicable; and
- (b) the personnel responsible for controlling access to the aerodrome, and the telephone numbers for contacting them during and after working hours.

##### (3) **Aerodrome emergency plan**

Particulars of the aerodrome emergency plan, including the following—

- (a) plans for dealing with emergencies occurring at the aerodrome or in its vicinity, including the malfunction of aircraft in flight;

structural fires; sabotage, including bomb threats to aircraft or structure; unlawful seizure of aircraft; and incidents on the aerodrome covering “during the emergency” and “after the emergency” considerations;

- (b) details of test and aerodrome facilities and equipment to be used in emergencies, including the frequency of those tests;
- (c) details of exercises to test emergency plans, including the frequency of those exercises;
- (d) a list of organisations, agencies and persons of authority, both on-and/off-aerodrome, for site roles; their telephone and facsimile numbers, e-mail addresses and the radio frequencies of their offices;
- (e) the establishment of an aerodrome emergency committee to organize training and other preparations for dealing with emergencies; and.
- (f) the appointment of an on-scene commander for the overall emergency operation.

#### (4) **Rescue and fire-fighting**

Particulars of the facilities, equipment, personnel and procedures for meeting the rescue and fire-fighting requirements, including the names and roles of the persons responsible for dealing with the rescue and fire-fighting services at the aerodrome.

#### (5) **Inspection of the aerodrome movement area**

Particulars of the procedures for the inspection of the aerodrome movement area and obstacle limitation surfaces, including the following—

- (i) arrangements for carrying out inspections, including runway friction and water-depth measurements on runways and taxiways, during and outside the normal hours of aerodrome operations;
- (ii) arrangements and means of communicating with air traffic control during an inspection;
- (iii) arrangements for keeping an inspection logbook, and the location of the logbook;



- (iv) details of inspection intervals and times;
- (v) inspection checklist;
- (vi) arrangements for reporting the results of inspections and for taking prompt follow-up actions to ensure correction of unsafe conditions; and
- (vii) the names and roles of persons responsible for carrying out inspections, and their telephone numbers during and after working hours.

**(6) Maintenance of the movement area**

Particulars of the facilities and procedures for the maintenance of the movement area, including arrangements for—

- (a) maintaining the paved areas;
- (b) maintaining the unpaved runways and taxiways;
- (c) maintaining the runway and taxiway strips; and
- (d) the maintenance of aerodrome drainage.

**(7) Hazardous meteorological conditions;**

Particulars of procedures for operating in hazardous meteorological conditions.

**(8) Visual aids and aerodrome electrical systems**

Particulars of the procedures for the inspection and maintenance of aeronautical lights, including obstacle lighting, signs, markers and aerodrome electrical systems, including the following—

- (a) arrangements for carrying out inspections during and outside the normal hours of aerodrome operation, and the checklist for such inspections;
- (b) arrangements for recording the result of inspections and for taking follow-up action to correct deficiencies;
- (c) arrangements for carrying out routine maintenance and emergency maintenance;

- (d) arrangements for secondary power supplies and, if applicable, the particulars of any other method of dealing with partial or total system failure; and
- (e) personnel responsible for the inspection and maintenance of the lighting, and the telephone numbers for contacting those persons during and after working hours.

**(9) Aerodrome works - safety**

Particulars of the procedures for planning and carrying out construction and maintenance work safely including work that may have to be carried out at short notice on or in the vicinity of the movement area which may extend above an obstacle limitation surface, including the following—

- (a) arrangements for communicating with air traffic control during the progress of such work;
- (b) the names, telephone numbers and roles of the persons and organisations responsible for planning and carrying out the work, and arrangements for contacting those persons and organisations at all times;
- (c) the names and telephone numbers, during and after working hours, of the aerodrome fixed-base operators, ground handling agents and aircraft operators who are to be notified of the work;
- (d) a distribution list for work plans, if required.

**(10) Apron management**

Particulars of the apron management procedures, including the following—

- (a) arrangements between air traffic control and the apron management unit;
- (b) arrangements for allocating aircraft parking positions;
- (c) arrangements for initiating engine start and ensuring clearance of aircraft push-back;
- (d) marshalling service; and
- (e) leader, van and service.

**(11) Apron safety management**

Procedures to ensure apron safety, including —

- (a) protection from jet blasts;
- (b) enforcement of safety precautions during aircraft refuelling operations;
- (c) apron sweeping;
- (d) apron cleaning;
- (e) arrangements for reporting incidents and accidents on an apron; and
- (f) arrangements for auditing the safety compliance of all personnel working on the apron.

**(12) Airside vehicle control**

Particulars of the procedure for the control of surface vehicles operating on or in the vicinity of the movement area, including the following—

- (a) details of the applicable traffic rules ,including speed limits and the means of enforcing the rules;
- (b) the method of issuing driving permits for operating vehicles in the movement area.

**(13) Wildlife hazard management**

Particulars of the procedures to deal with the danger posed to aircraft operations by the presence of birds or mammals in the aerodrome flight pattern or movement area, including the following—

- (a) arrangements for assessing birds and wildlife hazards;
- (b) arrangements for implementing birds and wildlife control programmes; and
- (c) the names and roles of the persons responsible for dealing with birds and wildlife hazards, and their telephone numbers during and after working hours.

**(14) Obstacle control**

Particulars setting out the procedures for—

- (a) monitoring the obstacle limitation surfaces and type A chart for obstacles in the take-off surface;
- (b) controlling obstacles within the authority of the aerodrome operator;
- (c) monitoring the height of buildings or structures within the boundaries of the obstacle limitation surfaces;
- (d) controlling new developments in the vicinity of aerodromes; and
- (e) notifying the Authority of the nature and location of obstacles and subsequent addition or removal of obstacles for action as necessary, including amendment of the Aeronautical Information Services publications.

**(15) Removal of disabled aircraft**

Particulars of the procedures for removing a disabled aircraft on or adjacent to the movement area, including the following—

- (a) the roles of the aerodrome operator and the holder of the aircraft operator certificate.
- (b) arrangements for notifying the aircraft operator.
- (c) arrangements for liaising with the air traffic control unit;
- (d) arrangements for obtaining equipment and personnel to remove the disabled aircraft; and
- (e) role and telephone numbers of personnel responsible for arranging for the action as necessary, including amendment of the AIS publications.

**(16) Handling of hazardous materials/dangerous goods**

Particulars of the procedures for the safe handling and storage of hazardous materials on the aerodrome, including the following —

- (a) arrangements for special areas of the aerodrome to be set up for the storage of inflammable liquids including aviation fuels and any other hazardous materials; and

- (b) the method to be followed for the delivery storage, dispensing and handling of hazardous materials.

For the purposes of this paragraph “hazardous materials” include inflammable liquids and solids, corrosive liquids, compressed gases and magnetised or radioactive materials.

**(17) Low visibility operations**

Particulars of procedures to be introduced for low-visibility operations, including the measurement and reporting of runway visual range as and when required, and the personnel, their telephone numbers, responsible for measuring the Runway Visual Range.

**(18) Protection of sites for radar and navigational aids**

Particulars of the procedures for the protection of sites for radar and radio navigational aids located on the aerodrome to ensure that their performance will not be degraded, including the following—

- (a) arrangements for the control of activities in the vicinity of radar and navigational aids installations;
- (b) arrangements for ground maintenance in the vicinity of these installations; and
- (c) arrangements for the supply and installation of signs warning of hazardous microwave radiation.

Note 1. In writing the procedures for each category, clear and precise information shall be included on—

- (i) when, or in what circumstances, an operating procedure is to be activated;
- (ii) how an operating procedure is to be activated;
- (iii) actions to be taken;
- (iv) the equipment necessary for carrying out the actions, and access to such equipment.

Note 2—If any of the procedures specified above are not relevant or applicable, reasons shall be given.

5. **PART 5: AERODROME ADMINISTRATION AND SAFETY MANAGEMENT SYSTEM**

(1) **Aerodrome administration**

Particulars of the aerodrome administration, including the following —

- (a) an aerodrome organisational chart showing the names and positions of key personnel, including their responsibilities;
- (b) the name, position and telephone number of the accountable executive who has overall responsibility for aerodrome safety; and
- (c) airport committees, including operational, planning, security, safety and emergency planning committees.

(2) **Safety Management System**

The safety management system shall follow the framework in 6.;

6. **SAFETY MANAGEMENT SYSTEM FRAMEWORK AT THE AERODROME;**

(1) **Requirement for safety management**

- (a) Aerodromes in category A shall have in place a system for managing safety, to which it is committed, is readily identifiable by the personnel of the aerodrome and the personnel of the Authority and is clearly documented in the Aerodrome Manual in accordance with the framework contained in this Schedule.
- (b) An aerodrome operator may elect to extend one SMS across multiple service provider activities.
- (c) This SMS framework consists of four components and twelve elements that constitute the minimum requirements for safety management system implementation.
- (d) Whilst an aerodrome operator shall ensure that its SMS is commensurate with the size and complexity of the aerodrome operation, where an SMS is mandated, all four components and twelve elements are mandatory regardless of the size and complexity of the operation.
- (e) An aerodrome and the facilities, equipment and systems of the aerodrome shall be designed and operated such that for any hazard, the combination of the probability of occurrence and

the severity of the consequences of the hazard occurring must not result in a level of risk that is below either the aerodrome operator's or the authority's acceptable level of safety performance.

(f) unless otherwise indicated —

“hazard” means situations or conditions that have the potential to cause harm to persons or damage to property.

“risk” means the combination of both the likelihood of occurrence of the hazard, and the severity of its potential consequences.

“accountability” refers to an “obligation” that may not be delegated. “responsibilities” refers to functions and activities that may be delegated.

“safety reporting procedures” includes incident, accident, and hazard reporting, all through mandatory, voluntary and self-disclosure safety reporting.

(2) **Management commitment**

(a) The aerodrome operator shall define its safety policy in accordance with the requirements contained in this Schedule and the safety policy shall—

(i) reflect organisational commitment of the aerodrome operator regarding safety, including the promotion of a positive safety culture;

(ii) include a clear statement about the provision of the necessary resources for the implementation of the safety policy;

(iii) include safety reporting procedures within a reporting environment where staff may trust that their actions or omissions that are commensurate with their training and experience will not be punished;

(iv) clearly indicate which types of behaviours are unacceptable related to the aerodrome operator's

activities and include the circumstances under which disciplinary action would not apply;

- (v) be signed by the accountable executive of the aerodrome operator;
  - (vi) be communicated, with visible endorsement, throughout the organisation;
  - (vii) be periodically reviewed to ensure it remains relevant and appropriate to the aerodrome operator.
- (b) Taking due account of its safety policy, the aerodrome operator shall define safety objectives. The safety objectives shall—
- (i) form the basis for safety performance monitoring and measurement as required by the Civil Aviation (Safety Management) Regulations, 2022;
  - (ii) reflect the aerodrome operator's commitment to maintain or continuously improve the overall effectiveness of the Safety Management System;
  - (iii) be communicated throughout the organisation;
  - (iv) be periodically reviewed to ensure they remain relevant and appropriate to the aerodrome operator.

### **(3) Safety accountability and responsibilities**

The aerodrome operator shall —

- (a) identify the accountable executive who, irrespective of other functions, is accountable on behalf of the organisation for the implementation and maintenance of an effective Safety Management System;
- (b) clearly define lines of safety accountability throughout the organisation, including a direct accountability for safety on the part of senior management;
- (c) identify the responsibilities of all members of management, irrespective of other functions, as well as of employees, with respect to the safety performance of the organisation;



- (d) document and communicate safety accountability, responsibilities and authorities throughout the organisation;
- (e) define the levels of management with authority to make decisions regarding safety risk tolerability.

**(4) Appointment of key safety personnel**

- (a) The aerodrome operator shall appoint a safety manager who is responsible for the implementation and maintenance of the Safety Management System.
- (b) Depending on the size of the aerodrome operator and the complexity of its services, the responsibilities for the implementation and maintenance of the Safety Management System may be assigned to one or more persons, fulfilling the role of safety manager, as their sole function or combined with other duties, provided that these do not result in any conflicts of interest.

**(5) Coordination of emergency response planning**

The aerodrome operator required to establish and maintain an emergency response plan for accidents and incidents in aircraft operations and other aviation emergencies shall ensure that the emergency response plan is properly coordinated with the emergency response plans of those organisations with which it must interface during the provision of its services.

**(6) Safety Management System documentation**

- (a) The aerodrome operator shall develop and maintain a Safety Management System manual that describes its—
  - (i) safety policy and objectives;
  - (ii) SMS requirements;
  - (iii) SMS processes and procedures;
  - (iv) accountability, responsibilities and authorities for SMS processes and procedures.
- (b) The aerodrome operator shall develop and maintain SMS operational records as part of its SMS documentation.

- (c) The aerodrome operator shall integrate the SMS manual and SMS operational records the aerodrome manual maintained by the aerodrome operator.

*Safety risk management*

(7) **Hazard identification**

- (a) The aerodrome operator shall develop and maintain a process to identify hazards associated with its aviation products or services.
- (b) Hazard identification shall be based on a combination of reactive and proactive methods.

(8) **Safety risk assessment and mitigation**

- (a) The aerodrome operator shall develop and maintain a process that ensures analysis, assessment and control of the safety risks associated with identified hazards.
- (b) The process may include predictive methods of safety data analysis.

*Safety assurance*

(9) **Safety performance monitoring and measurement**

- (a) The aerodrome operator shall develop and maintain the means to verify the safety performance of the organisation and to validate the effectiveness of safety risk controls.
- (b) The aerodrome operator's safety performance shall be verified in reference to the safety performance indicators and safety performance targets of the SMS in support of the organisation's safety objectives.
- (c) An aerodrome operator shall document and undertake an internal audit process to monitor compliance with safety regulations and its own safety policy and objectives, and assess the effectiveness of these safety risk controls and the SMS.
- (d) Self monitoring such as incident investigations, safety inspections and safety audits is a part of this process.

(10) **The management of change**

The aerodrome operator shall develop and maintain a process to identify changes which may affect the level of safety risk associated with its aviation products or services and to identify and manage the safety risks that may arise from those changes.

(11) **Continuous improvement of the Safety Management System.**

The aerodrome operator shall monitor and assess its Safety Management System processes to maintain or continuously improve the overall effectiveness of the Safety Management System.

*Safety promotion*

(12) **Training and education**

(a) The aerodrome operator shall develop and maintain a safety training programme that ensures that personnel are trained and competent to perform their Safety Management System duties.

(b) The scope of the safety training programme shall be appropriate to each individual's involvement in the Safety Management System.

(13) **Safety communication**

The aerodrome operator shall develop and maintain a formal means for safety communication that—

(a) ensures personnel are aware of the SMS to a degree commensurate with their positions;

(b) conveys safety-critical information;

(c) explains why particular actions are taken to improve safety;

(d) explains why safety procedures are introduced or changed.

7. **SAFETY REPORTING AT AERODROMES**

(1) **Aerodrome occurrence reporting**

(a) This part prescribes the requirements for reporting the occurrence or detection of defects, failures or malfunctions at an aerodrome, its components or equipment, which could jeopardize the safe operation of the aerodrome or cause it to become a danger to persons or property.

- (b) The objectives of the aerodrome occurrence reports are as follows—
  - (i) to ensure that knowledge of these occurrences is disseminated so that other persons and organisations may learn from them; and
  - (ii) to enable an assessment to be made by those concerned (whether internal or external to the aerodrome operator) of the safety implications of each occurrence, both in itself and in relation to previous similar occurrences, so that they may take or initiate any necessary action.

(2) **Reportable occurrences and reporting procedures**

- (a) An aerodrome operator shall notify the Authority of any accident, serious incident, fatal or serious injury occurring at the aerodrome as soon as practicable after the occurrence and provide a detailed occurrence report thereafter.
- (b) Serious incident” includes—
  - (i) a near collision requiring avoidance manoeuvre to avoid a collision or an unsafe situation or where an avoidance action would have been appropriate;
  - (ii) a controlled flight into terrain only marginally avoided;
  - (iii) an aborted take-off on a closed or engaged runway;
  - (iv) a take-off from a closed or engaged runway with marginal separation from an obstacle;
  - (v) a landing or attempted landing on a closed or engaged runway;
  - (vi) a take-off or landing incident such as undershooting; or overrunning or running off the side of runways; or
  - (vii) a major failure of any navigation aid when a runway is in use;
- (c) serious injury means any injury that is sustained by a person in an accident and that—

- (i) requires hospitalisation for more than forty eight hours, commencing within seven days from the date the injury was received;
  - (ii) results in a fracture of any bone, except simple fractures of fingers, toes or nose;
  - (iii) involves lacerations which cause severe haemorrhage, nerve, muscle, or tendon damage;
  - (iv) involves any injury to any internal organ;
  - (v) involves second or third degree burns, or any burns affecting more than 5% of the body surface; or
  - (vi) involves verified exposure to infectious substances or injurious radiation.
- (d) The aerodrome operator shall notify the Authority that notifies the Aircraft Accident and Incident Investigation Bureau whenever an accident or serious incident occurs on or adjacent to his aerodrome in accordance with the provisions of the Civil Aviation (Aircraft Accident and Incident Investigation) Regulations, 2022.
- (e) Information to be provided in the reporting and notification of an accident, serious incident or serious injury shall as far as possible include the following—
- (i) the date and local time of occurrence;
  - (ii) the exact location of the occurrence with reference to some easily defined geographical point ;
  - (iii) detailed particulars of the parties involved, including the owner, aircraft operator, manufacturer, nationality, registration marks, serial numbers, assigned identities of aircraft and equipment;
  - (iv) a detailed description of the sequence of events leading up to the incident;

- (v) the physical characteristics, environment or circumstances of the area in which the incident occurred and an indication of the access difficulties or special requirements to reach the site;
- (vi) the identification of the person sending the notice and where the incident occurred;
- (vii) in the case of an aircraft accident, the number of crew members, passengers or other persons respectively killed or seriously injured as a result of the accident; and
- (viii) a description of the follow-up action being taken after the incident has occurred.

(3) **Aerodrome occurrence records**

- (a) An aerodrome operator shall establish and maintain aerodrome occurrence reports for any accident, serious incident, serious injury or any occurrence or event that has a bearing on the safety of aerodrome operations.
- (b) An aerodrome operator shall use aerodrome occurrence reports to monitor and improve the level of operational safety, including reviews of safety standards required.
- (c) The Authority may require the aerodrome operator to produce and provide information contained in the aerodrome occurrence report relating to any safety occurrence or event.

## **B. AERODROMES IN CATEGORY B AND C**

### **1. PART 1: GENERAL**

General information, including the following—

- (1) amendment record page;
- (2) Checklist of pages;
- (3) Contents;
- (4) purpose and scope of the aerodrome manual;
- (5) the legal requirement for an aerodrome licence;
- (6) conditions for use of the aerodrome - a statement to indicate that the aerodrome shall at all times, when it is available for the take-off and landing of aircraft, be so available to all persons on equal terms and conditions;
- (7) the available aeronautical information system and procedures for its promulgation;
- (8) the system for recording aircraft movements; and
- (9) obligations of the aerodrome operator.

### **2. PART 2: PARTICULARS OF THE AERODROME SITE**

General information, including the following—

- (1) a plan of the aerodrome showing the main aerodrome facilities for the operation of the aerodrome including, particularly, the location of each wind direction indicator;
- (2) a plan of the aerodrome showing the aerodrome boundaries; and
- (3) a plan showing the distance of the aerodrome from the nearest city, town or other populous area, and the location of any aerodrome facilities and equipment outside the boundaries of the aerodrome.
- (4) Particulars of the land title of the aerodrome site. If the boundaries of the aerodrome are not defined in the land title documents particulars of the land title to, or interest in, the property on which the aerodrome is located and a plan showing the boundaries and position of the aerodrome.

3. **PART 3: PARTICULARS OF THE AERODROME REQUIRED TO BE REPORTED TO THE AERONAUTICAL INFORMATION SERVICE (AIS)**

(1) General Information—

- (a) the name and location indicator of the aerodrome;
- (b) the location of the aerodrome;
- (c) the geographical coordinates of the aerodrome reference point determined in terms of the World Geodetic System - 1984 (WGS- 84) reference datum;
- (d) direction and distance of aerodrome reference point from centre of the city or town which the aerodrome serves;
- (e) the aerodrome elevation;
- (f) points along the runway, and the highest elevation of the touchdown zone of a precision approach runway;
- (g) the aerodrome reference temperature;
- (h) the name of the aerodrome operator and the address, telephone numbers and email at which the aerodrome operator may be contacted at all times.

(2) Operational hours, a detailed description of the hours of operation of services at the aerodrome, including the aerodrome operator and where applicable—

- (a) customs and immigration;
- (b) health and sanitation;
- (c) AIS briefing office;
- (d) ATS reporting office (ARO);
- (e) MET briefing office;
- (f) air traffic service;
- (g) fuelling;



- (h) handling;
  - (i) security; and remarks.
- (3) Where applicable, handling services and facilities which are available at the aerodrome, including—
- (a) fuel and oil types;
  - (b) fuelling facilities and capacity;
  - (c) hangar space for visiting aircraft;
  - (d) repair facilities for visiting aircraft; and remarks.
- (4) Where applicable, passenger facilities which are available at the aerodrome such as a website including—
- (a) hotel at or in the vicinity of aerodrome;
  - (b) restaurant at or in the vicinity of aerodrome;
  - (c) transportation possibilities;
  - (d) medical facilities;
  - (e) bank and post office at or in the vicinity of aerodrome;
  - (f) tourist office; and remarks.
- (5) Where applicable, Rescue and fire-fighting services which are available at the aerodrome, including—
- (a) aerodrome category for firefighting;
  - (b) rescue equipment;
  - (c) capability for removal of disabled aircraft; and remarks
- (6) Where applicable, aprons, taxiways and check locations/positions data and details relating to the physical characteristics of aprons, taxiways locations or positions of designated checkpoints.

- (7) Aerodrome obstacles, a detailed description of obstacles, including—
- (a) obstacle identification or designation;
  - (b) type of obstacle;
  - (c) obstacle position, represented by geographical coordinates in degrees, minutes, seconds and tenths of seconds;
  - (d) obstacle elevation and height to the nearest foot;
  - (e) obstacle marking, and type and colour of obstacle lighting, if any;
- (8) Where applicable, a detailed description of meteorological information provided at the aerodrome.
- (9) Runway physical characteristics, a detailed description of runway physical characteristics, for each runway, including —
- (a) designations;
  - (b) true bearings to one-hundredth of a degree;
  - (c) dimensions of runways to the nearest foot;
  - (d) where applicable, the strength of pavement (PCN and associated data) and surface of each runway and associated stopways;
  - (e) geographical coordinates in degrees, minutes, seconds and hundredths of seconds for each threshold and runway end and, where appropriate, geoid undulation of—
  - (f) elevations of thresholds to the nearest tenth of a foot;
  - (g) slope of each runway and associated stopways;
  - (h) dimensions of stopway, if any, to the nearest meter;
  - (i) dimensions of clearway, if any, to the nearest meter;
  - (j) dimensions of strips;
  - (k) dimensions of runway end safety areas;

- (l) location, which runway end;
  - (m) the existence of an obstacle-free zone if any; and remarks.
- (10) Declared distances a detailed description of declared distances to the nearest meter for each direction of each runway, including—
- (a) runway designator;
  - (b) take-off run available;
  - (c) take-off distance available, and if applicable, alternative reduced declared distances;
  - (d) accelerate-stop distance available;
  - (e) landing distance available; and
  - (f) remarks, including runway entry or start point where alternative reduced declared distances have been declared, and

If a runway direction cannot be used for take-off or landing, or both, because it is operationally forbidden, then this must be declared and the words “not usable” or the abbreviation “NU” entered.

- (11) Where applicable, a detailed description of approach, runway lighting and other lighting including secondary power supply.
- (12) Where applicable, a detailed description of air traffic services (ATS) airspace organised at the aerodrome and ATS communication facilities established at the aerodrome.
- (13) Where applicable, a detailed description of radio navigation and landing aids associated with the instrument approach and the terminal area procedures at the aerodrome.
- (14) Where applicable, information at the aerodrome, such as an indication of bird concentrations at the aerodrome, together with an indication of significant daily movement between resting and feeding areas, to the extent practicable.

4. **PART 4: PARTICULARS OF THE AERODROME OPERATING PROCEDURES AND SAFETY MEASURES**

(1) **Aerodrome reporting**

Particulars of the procedures for reporting any changes to the aerodrome information set out in the AIP and AIC and procedures for requesting the issue of NOTAMs, including the following—

- (a) arrangements for reporting any changes to the Authority and recording the reporting of changes during and outside the normal hours of aerodrome operations;
- (b) the names and roles of persons responsible for notifying the changes, and their telephone numbers during and outside the normal hours of aerodrome operations; and
- (c) the address and telephone numbers and email, as provided by the Authority, of the place where changes are to be reported to the Authority.

(2) **Access to the aerodrome movement area**

Particulars of the procedures that have been developed and are to be followed in coordination with the agency responsible for preventing unlawful interference in civil aviation at the aerodrome and for preventing unauthorised entry of persons, vehicles, equipment, animals or other things into the movement area, including the following—

- (a) the role of the aerodrome operator, the aircraft operator, aerodrome fixed-base operator, the aerodrome security entity, the Authority and other government departments, as applicable;
- (b) the personnel responsible for controlling access to the aerodrome, and the telephone numbers for contacting them during and after working hours;
- (c) inspection checklist;
- (d) arrangements for reporting the results of inspections and for taking prompt follow-up actions to ensure correction of unsafe conditions; and
- (e) the names and roles of persons responsible for carrying out inspections, and their telephone numbers during and after working hours.

**(3) Aerodrome emergency plan**

Where applicable, particulars of the aerodrome emergency plan.

**(4) Rescue and fire-fighting**

Where applicable, particulars of the facilities, equipment, personnel and procedures for meeting the rescue and fire-fighting requirements, including the names and roles of the persons responsible for dealing with the rescue and fire-fighting services at the aerodrome.

**(5) Inspection of the aerodrome movement area and obstacle limitation surfaces**

Where applicable, particulars of the procedures for the inspection of the aerodrome movement area and obstacle limitation surfaces, including the following—

- (a) arrangements for carrying out inspections, including runway friction and water-depth measurements on runways and taxiways, during and outside the normal hours of aerodrome operations;
- (b) arrangements and means of communicating with air traffic control during an inspection;
- (c) arrangements for keeping an inspection logbook, and the location of the logbook;
- (d) details of inspection intervals and times;
- (e) inspection checklist;
- (f) arrangements for reporting the results of inspections and for taking prompt follow-up actions to ensure correction of unsafe conditions; and
- (g) the names and roles of persons responsible for carrying out inspections, and their telephone numbers during and after working hours.

**(6) Visual aids and aerodrome electrical systems**

Where applicable, particulars of the procedures for the inspection and maintenance of aeronautical lights, including obstacle lighting, signs, markers and aerodrome electrical systems, including the following—

- (a) arrangements for carrying out inspections during and outside the normal hours of aerodrome operation, and the checklist for such inspections;
- (b) arrangements for recording the result of inspections and for taking follow-up action to correct deficiencies;
- (c) arrangements for carrying out routine maintenance and emergency maintenance;
- (d) arrangements for secondary power supplies and, if applicable, the particulars of any other method of dealing with partial or total system failure; and
- (e) personnel responsible for the inspection and maintenance of the lighting, and the telephone numbers for contacting those persons during and after working hours.

**(7) Maintenance of the movement area**

Particulars of the facilities and procedures for the maintenance of the movement area, including—

- (a) arrangements for maintaining the unpaved runways and taxiways;
- (b) arrangements for maintaining the runway and taxiway strips; and
- (c) arrangements for the maintenance of aerodrome drainage.

**(8) Visual aids and aerodrome electrical systems**

Where applicable, particulars of the procedures for the inspection and maintenance of aeronautical lights, including obstacle lighting, signs, markers and aerodrome electrical systems.

**(9) Aerodrome works – safety**

Particulars of the procedures for planning and carrying out construction and maintenance work safely (including work that may have to be carried out at short notice) on or in the vicinity of the movement area which may extend above an obstacle limitation surface, including the following—

- (a) the names, telephone numbers and roles of the persons and organisations responsible for planning and carrying out the work, and arrangements for contacting those persons and organisations at all times;

- (b) a distribution list for work plans, if required.

**(10) Apron management and apron safety procedures**

Where applicable, a brief description of apron management and apron safety management procedures.

**(11) Birds and Wildlife Hazard Management**

Where applicable, particulars of the procedures to deal with the danger posed to aircraft operations by the presence of birds or mammals in the aerodrome flight pattern or movement area, including the following—

- (a) arrangements for assessing birds and wildlife hazards;
- (b) arrangements for implementing birds and wildlife control programmes; and
- (c) the names and roles of the persons responsible for dealing with birds and wildlife hazards, and their telephone numbers during and after working hours.

**(12) Obstacle Control**

Particulars setting out the procedures for—

- (a) monitoring the obstacle limitation surfaces and Type A Chart (Cat B aerodromes) for obstacles in the take-off surface
- (b) controlling obstacles within the authority of the aerodrome operator;
- (c) monitoring the height of buildings or structures within the boundaries of the obstacle limitation surfaces;
- (d) controlling new developments in the vicinity of aerodromes; and
- (e) notifying the Authority of the nature and location of obstacles and subsequent addition or removal of obstacles for action as necessary, including amendment of the AIS publications.

**(13) Removal of disabled aircraft**

Particulars of the procedures for removing a disabled aircraft on or adjacent to the movement area, including the following —

- (a) the roles of the aerodrome operator and the holder of the aircraft operator certificate.
- (b) arrangements for notifying the aircraft operator.
- (c) arrangements for liaising with the air traffic control unit;
- (d) arrangements for obtaining equipment and personnel to remove the disabled aircraft; and
- (e) role and telephone numbers of personnel responsible for arranging for the action as necessary, including amendment of the AIS publications.

**(14) Handling of Hazardous Materials**

Where applicable, particulars of the procedures for the safe handling and storage of hazardous materials on the aerodrome, including the following—

- (a) Where applicable, particulars of low visibility procedures
- (b) Where applicable, particulars of the protection of sites for radar and radio navigational aids located on the aerodrome to ensure that their performance will not be degraded.

**5. PART 5: AERODROME ADMINISTRATION AND SAFETY MANAGEMENT SYSTEM**

**(1) Aerodrome administration**

Particulars of the aerodrome administration, including the following—

- (a) an aerodrome organisational chart showing the names and positions of key personnel, including their responsibilities;
- (b) (a) the name, position and telephone number of the accountable executive who has overall responsibility for aerodrome safety;

**(2) Safety Management System**

Where applicable, the safety management system for the aerodrome.



## SCHEDULE 2

*Regulation 122, 128*

### SHIELDING OF OBSTACLES

#### 1. General

- (1) The principle of shielding as applied to obstacles to air navigation may reduce the necessity for removing obstacles or prohibiting the construction of new constructions.
- (2) Shielding principles are employed when some object, an existing building or natural terrain already penetrates above one of the obstacle limitation surfaces.

#### 2. The principles of Shielding

- (1) If it is considered that the nature of an object is such that its presence may be described as permanent, the additional objects within a specified area around it may be permitted to penetrate the surface without being considered as obstacles. The original obstacle is considered as dominating or shielding the surrounding area.
- (2) The formula for shielding shall be based on a horizontal plane projected from the top of each obstacle away from the runway and a plane with a negative slope of 10% towards the runway. Any object which is below either of the two planes would be considered shielded. The permission to allow objects to penetrate an obstacle limitation surface under the shielding principle shall however be qualified by reference to the need for an aeronautical study in all cases.
- (3) The shielding effect of immovable obstacles laterally in approach and take-off climb shall be more critically considered. It is important to preserve existing unobstructed cross section areas particularly when the obstacle is close to the runway. This would guard against future changes in either approach or take-off climb area specifications or the adoption of a turned take-off procedure.

- (4) An object shall be considered as permanent and immovable obstacle only if, when taking the longest view possible, there is no prospect of removal being practicable, possible or justifiable, regardless of how the pattern, type or density of air operations might change. Generally, an aeronautical study will need to be carried out to determine the exact effect the construction of a new object will have on air operations.

### **3. Alternative methods for assessing obstacles in critical areas**

The Authority may assess and determine whether an obstacle is shielded. In assessing whether an existing obstacle shields other obstacles, the Authority may be guided by the following shielding practices:

#### **(1) Obstacles in the Take-off climb and Approach Surfaces**

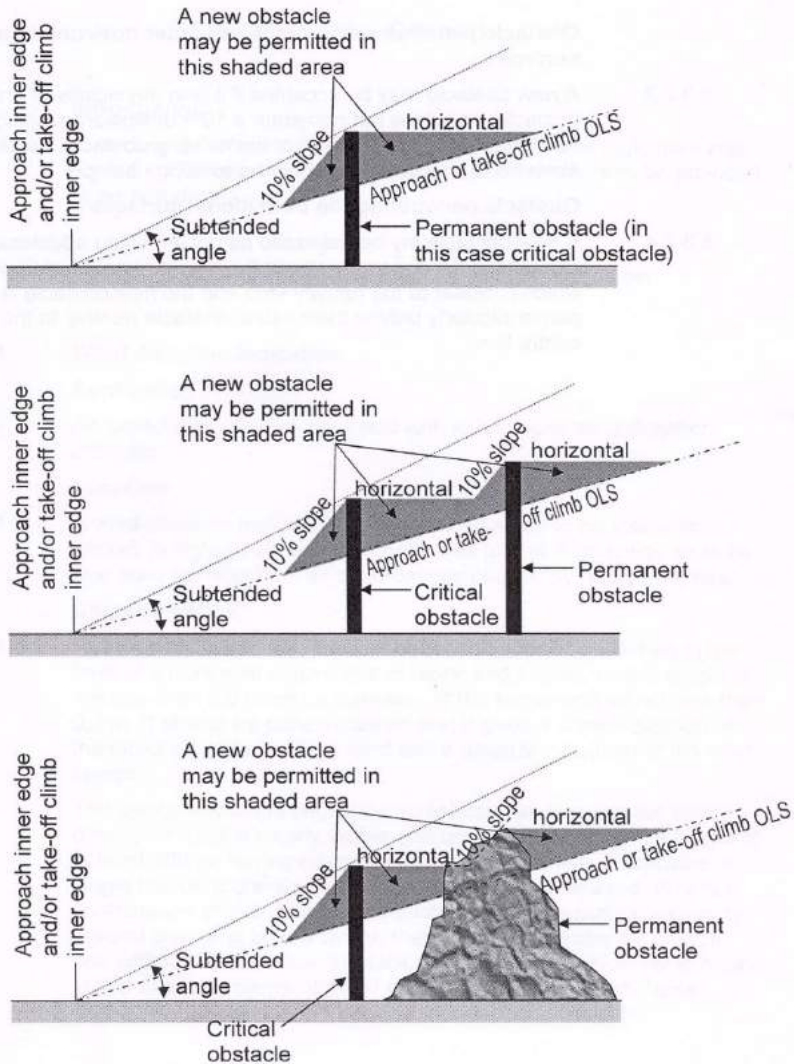
An obstacle may be assessed as not imposing additional restrictions if—

- (a) when located between the inner edge end and the critical obstacle, the obstacle being assessed is below a plane sloping downwards at 10% from the top of the critical obstacle toward the inner edge;
- (b) when located beyond the critical obstacle from the inner edge end, the obstacle being assessed is not higher than the height of the permanent obstacle; and
- (c) where there is more than one critical obstacle within the approach and take-off climb area, and the obstacle being assessed is located between two critical obstacles, the height of the obstacle being assessed is not above a plane sloping downwards at 10% from the top of the next critical obstacle.

#### **(2) Obstacle in the Transitional Surfaces**

An obstacle may be assessed as not imposing additional restrictions if it does not exceed the height of an existing obstacle which is closer to the runway strip and the obstacle being assessed is located perpendicularly behind the existing obstacle relative to the runway centre line.

**Figure 4-3 – Shielding of obstacles penetrating the approach and take-off climb surfaces**



**(3) Obstacle in the Horizontal and Conical Surfaces**

An obstacle may be assessed as not imposing additional restrictions if it is in the vicinity of an existing obstacle, and does not penetrate a 10% downward sloping conical shaped surface from the top of the existing obstacle, i.e. the obstacle is shielded radially by the existing obstacle.

## SCHEDULE 3

*Regulations 2,219, 220*

### **COLOURS FOR AERONAUTICAL GROUND LIGHTS, MARKINGS, SIGNS AND PANELS**

#### **1. General**

- (1) The following specifications define the chromaticity limits of colours to be used for aeronautical ground lights, markings, signs and panels. The specifications are in accord with the 1983 specifications of the International Commission on Illumination (CIE), except for the colour orange in Figure S3-2.
- (2) It is not possible to establish specifications for colours such that there is no possibility of confusion.
- (3) For reasonably certain recognition, it is important that the eye illumination be well above the threshold of perception, that the colour not be greatly modified by selective atmospheric attenuations and that the observer's colour vision be adequate. There is also a risk of confusion of colour at an extremely high level of eye illumination such as may be obtained from a high-intensity source at very close range. Experience indicates that satisfactory recognition can be achieved if due attention is given to these factors.
- (4) The chromaticities are expressed in terms of the standard observer and coordinate system adopted by the International Commission on Illumination (CIE) at its Eighth Session at Cambridge, England, in 1931.
- (5) The chromaticities for solid state lighting such as LED are based upon the boundaries given in the standard S 004/E-2001 of the International Commission on Illumination (CIE), except for the blue boundary of white.

#### **2. Colours for aeronautical ground lights**

- (1) Chromaticities for lights having filament-type light sources
  - (a) The chromaticities of aeronautical ground lights with filament-type light sources shall be within the following boundaries:  
CIE Equations (see Figure S3-1a):

- (i) Red  
 Purple boundary  $y = 0.980 - x$   
 Yellow boundary  $y = 0.335$ , except for visual approach slope indicator systems  
 Yellow boundary  $y = 0.320$ , for visual approach slope indicator systems
- (ii) Yellow  
 Red boundary  $y = 0.382$   
 White boundary  $y = 0.790 - 0.667x$   
 Green boundary  $y = x - 0.120$
- (iii) Green  
 Yellow boundary  $x = 0.360 - 0.080y$   
 White boundary  $x = 0.650y$   
 Blue boundary  $y = 0.390 - 0.171x$
- (iv) Blue  
 Green boundary  $y = 0.805x + 0.065$   
 White boundary  $y = 0.400 - x$   
 Purple boundary  $x = 0.600y + 0.133$
- (v) White  
 Yellow boundary  $x = 0.500$   
 Blue boundary  $x = 0.285$   
 Green boundary  $y = 0.440$  and  $y = 0.150 + 0.640x$   
 Purple boundary  $y = 0.050 + 0.750x$  and  $y = 0.382$
- (vi) Variable white  
 Yellow boundary  $x = 0.255 + 0.750y$  and  $y = 0.790 - 0.667x$   
 Blue boundary  $x = 0.285$   
 Green boundary  $y = 0.440$  and  $y = 0.150 + 0.640x$   
 Purple boundary  $y = 0.050 + 0.750x$  and  $y = 0.382$

- (b) Where dimming is not required, or where observers with defective colour vision must be able to determine the colour of the light, green signals shall be within the following boundaries:

Yellow boundary	$y = 0.726 - 0.726x$
White boundary	$x = 0.650y$
Blue boundary	$y = 0.390 - 0.171x$

Note. Where the colour signal is to be seen from long range, it has been the practice to use colours within the boundaries of (b)

- (c) Where increased certainty of recognition from white is more important than maximum visual range, green signals shall be within the following boundaries:

Yellow boundary	$y = 0.726 - 0.726x$
White boundary	$x = 0.625y - 0.041$
Blue boundary	$y = 0.390 - 0.171x$

(2) Discrimination between lights having filament-type sources

- (a) If there is a requirement to discriminate yellow and white from each other, they shall be displayed in close proximity of time or space as, for example, by being flashed successively from the same beacon.
- (b) If there is a requirement to discriminate yellow from green and/ or white, as for example on exit taxiway centre line lights, the y coordinates of the yellow light shall not exceed a value of 0.40.

Note. The limits of white have been based on the assumption that they will be used in situations in which the characteristics (colour temperature) of the light source will be substantially constant.

- (c) The colour variable white is intended to be used only for lights that are to be varied in intensity, for example, to avoid dazzling. If this colour is to be discriminated from yellow, the lights shall be so designed and operated that—

- (i) the x coordinate of the yellow is at least 0.050 greater than the x coordinate of the white; and
  - (ii) the disposition of the lights will be such that the yellow lights are displayed simultaneously and in close proximity to the white lights.
- (3) Chromaticities for lights having a solid state light source
- (a) The chromaticities of aeronautical ground lights with solid state light sources, e.g. LEDs, shall be within the following boundaries:

CIE Equations (see Figure S4-1b):

- (i) Red
  - Purple boundary  $y = 0.980 - x$
  - Yellow boundary  $y = 0.335$ , except for visual approach slope indicator systems
  - Yellow boundary  $y = 0.320$ , for visual approach slope indicator systems
- (ii) Yellow
  - Red boundary  $y = 0.387$
  - White boundary  $y = 0.980 - x$
  - Green boundary  $y = 0.727x + 0.054$
- (iii) Green (also refer to (3) (b) and (3) (c) below)
  - Yellow boundary  $x = 0.310$
  - White boundary  $x = 0.625y - 0.041$
  - Blue boundary  $y = 0.400$
- (iv) Blue
  - Green boundary  $y = 1.141x - 0.037$
  - White boundary  $y = 0.400 - y$
  - Purple boundary  $x = 0.134 + 0.590y$

- (v) White
  - Yellow boundary  $x = 0.440$
  - Blue boundary  $x = 0.320$
  - Green boundary  $y = 0.150 + 0.643x$
  - Purple boundary  $y = 0.050 + 0.757x$

(vi) Variable white

The boundaries of variable white for solid state light sources are those of (v) White above.

Where observers with defective colour vision must be able to determine the colour of the light, green signals shall be within the following boundaries:

- Yellow boundary  $y = 0.726 - 0.726x$
- White boundary  $x = 0.625y - 0.041$
- Blue boundary  $y = 0.400$

In order to avoid a large variation of shades of green, if colours within the boundaries below are selected, colours within the boundaries of (3) (ii) shall not be used.

- Yellow boundary  $x = 0.310$
- White boundary  $x = 0.625y - 0.041$
- Blue boundary  $y = 0.726 - 0.726x$

(4) Colour measurement for filament-type and solid state-type light sources

- (a) The colour of aeronautical ground lights shall be verified as being within the boundaries specified in Figure S3- 1a or S3-1b, as appropriate, by measurement at five points within the area limited by the innermost isocandela curve (isocandela diagrams in Schedule 4 refer), with operation at rated current or voltage.
- (b) In the case of elliptical or circular isocandela curves, the colour measurements shall be taken at the centre and at the horizontal and vertical limits. In the case of rectangular isocandela curves, the colour measurements



shall be taken at the centre and the limits of the diagonals (corners). In addition, the colour of the light shall be checked at the outermost isocandela curve to ensure that there is no colour shift that might cause signal confusion to the pilot.

Note 1. For the outermost isocandela curve, a measurement of colour coordinates shall be made and recorded for review and judgement of acceptability by the State.

Note 2. Certain light units may have application so that they may be viewed and used by pilots from directions beyond that of the outermost isocandela curve (e.g. stop bar lights at significantly wide runway-holding positions). In such instances, the authority shall assess the actual application and if necessary require a check of colour shift at angular ranges beyond the outermost curve.

(c) In the case of visual approach slope indicator systems and other light units having a colour transition sector, the colour shall be measured at points in accordance with 2 (4) (b) above, except that the colour areas shall be treated separately and no point shall be within 0.5 degrees of the transition sector.

### 3. Colours for markings, signs and panels

Note 1. The specifications of surface colours given below apply only to freshly coloured surfaces. Colours used for markings, signs and panels usually change with time and therefore require renewal.

Note 2. Guidance on surface colours is contained in the CIE document entitled recommendations for Surface Colours for Visual Signalling — Publication No. 39-2 (TC-106) 1983.

Note 3. The specifications recommended in 3 (3) below for transilluminated panels are interim in nature and are based on the CIE specifications for transilluminated signs. It is intended that these specifications will be reviewed and updated as and when CIE develops specifications for transilluminated panels.

- (1) The chromaticities and luminance factors of ordinary colours, colours of retroreflective materials and colours of transilluminated (internally illuminated) signs and panels shall be determined under the following standard conditions:
  - (a) angle of illumination: 45°;
  - (b) direction of view: perpendicular to surface; and
  - (c) illuminant: CIE standard illuminant D<sub>65</sub>.
  
- (2) The chromaticity and luminance factors of ordinary colours for markings and externally illuminated signs and panels shall be within the following boundaries when determined under standard conditions.

CIE Equations (see Figure S1-2):

- (i) Red
 

Purple boundary	$y = 0.345 - 0.051x$
White boundary	$y = 0.910 - x$
Orange boundary	$y = 0.314 + 0.047x$
Luminance factor	$\beta = 0.07$ (mnm)
  
- (ii) Orange
 

Red boundary	$y = 0.285 + 0.100x$
White boundary	$y = 0.940 - x$
Yellow boundary	$y = 0.250 + 0.220x$
Luminance factor	$\beta = 0.20$ (mnm)
  
- (iii) Yellow
 

Orange boundary	$y = 0.108 + 0.707x$
White boundary	$y = 0.910 - x$
Green boundary	$y = 1.35x - 0.093$
Luminance factor	$\beta = 0.45$ (mnm)
  
- (iv) White
 

Purple boundary	$y = 0.010 + x$
Blue boundary	$y = 0.610 - x$

	Green boundary	$y = 0.030 + x$
	Yellow boundary	$y = 0.710 - x$
	Luminance factor	$\beta = 0.75$ (mnm)
(v)	Black	
	Purple boundary	$y = x - 0.030$
	Blue boundary	$y = 0.570 - x$
	Green boundary	$y = 0.050 + x$
	Yellow boundary	$y = 0.740 - x$
	Luminance factor	$\beta = 0.03$ (max)
(vi)	Yellowish green	
	Green boundary	$y = 1.317x + 0.4$
	White boundary	$y = 0.910 - x$
	Yellow boundary	$y = 0.867x + 0.4$
(vii)	Green	
	Yellow boundary	$x = 0.313$
	White boundary	$y = 0.243 + 0.670x$
	Blue boundary	$y = 0.493 - 0.524x$
	Luminance factor	$\beta = 0.10$ (mnm)

The chromaticity and luminance factors of colours of retroreflective materials for markings, signs and panels shall be within the following boundaries when determined under standard conditions.

CIE Equations (see Figure S1-3):

(a)	Red	
	Purple boundary	$y = 0.345 - 0.051x$
	White boundary	$y = 0.910 - x$
	Orange boundary	$y = 0.314 + 0.047x$
	Luminance factor	$\beta = 0.03$ (mnm)

- (b) Orange
- |                  |                      |
|------------------|----------------------|
| Red boundary     | $y = 0.265 + 0.205x$ |
| White boundary   | $y = 0.910 - x$      |
| Yellow boundary  | $y = 0.207 + 0.390x$ |
| Luminance factor | $\beta = 0.14$ (mnm) |
- (c) Yellow
- |                  |                      |
|------------------|----------------------|
| Orange boundary  | $y = 0.160 + 0.540x$ |
| White boundary   | $y = 0.910 - x$      |
| Green boundary   | $y = 1.35x - 0.093$  |
| Luminance factor | $\beta = 0.16$ (mnm) |
- (d) White
- |                  |                      |
|------------------|----------------------|
| Purple boundary  | $y = x$              |
| Blue boundary    | $y = 0.610 - x$      |
| Green boundary   | $y = 0.040 + x$      |
| Yellow boundary  | $y = 0.710 - x$      |
| Luminance factor | $\beta = 0.27$ (mnm) |
- (e) Blue
- |                  |                      |
|------------------|----------------------|
| Green boundary   | $y = 0.118 + 0.675x$ |
| White boundary   | $y = 0.370 - x$      |
| Purple boundary  | $y = 1.65x - 0.187$  |
| Luminance factor | $\beta = 0.01$ (mnm) |
- (f) Green
- |                  |                      |
|------------------|----------------------|
| Yellow boundary  | $y = 0.711 - 1.22x$  |
| White boundary   | $y = 0.243 + 0.670x$ |
| Blue boundary    | $y = 0.405 - 0.243x$ |
| Luminance factor | $\beta = 0.03$ (mnm) |

- (3) The chromaticity and luminance factors of colours for luminescent or transilluminated (internally illuminated) signs and panels shall be within the following boundaries when determined under standard conditions.  
CIE Equations (see Figure S3-4):

- (a) Red
- |   |                                      |
|---|--------------------------------------|
| Purple boundary                               | $y = 0.345 - 0.051x$                 |
| White boundary                                | $y = 0.910 - x$                      |
| Orange boundary                               | $y = 0.314 + 0.047x$                 |
| Luminance factor                              | $\beta = 0.07$ (mnm) (day condition) |
| Relative luminance to white (night condition) | 5% (mnm)<br>20% (max)                |
- (b) Yellow
- |   |                                      |
|---|--------------------------------------|
| Orange boundary                               | $y = 0.108 + 0.707x$                 |
| White boundary                                | $y = 0.910 - x$                      |
| Green boundary                                | $y = 1.35x - 0.093$                  |
| Luminance factor                              | $\beta = 0.45$ (mnm) (day condition) |
| Relative luminance to white (night condition) | 30% (mnm)<br>80% (max)               |
- (c) White
- |   |                                      |
|---|--------------------------------------|
| Purple boundary                               | $y = 0.010 + x$                      |
| Blue boundary                                 | $y = 0.610 - x$                      |
| Green boundary                                | $y = 0.030 + x$                      |
| Yellow boundary                               | $y = 0.710 - x$                      |
| Luminance factor                              | $\beta = 0.75$ (mnm) (day condition) |
| Relative luminance to white (night condition) | 100%                                 |
- (d) Black
- |                 |                 |
|-----------------|-----------------|
| Purple boundary | $y = x - 0.030$ |
| Blue boundary   | $y = 0.570 - x$ |
| Green boundary  | $y = 0.050 + x$ |
| Yellow boundary | $y = 0.740 - x$ |

Luminance factor  $\beta = 0.03$  (max) (day condition)

Relative luminance to white (night condition)  
 0%(mnm)  
 2% (max)

(e) Green

Yellow boundary:  $x = 0.313$

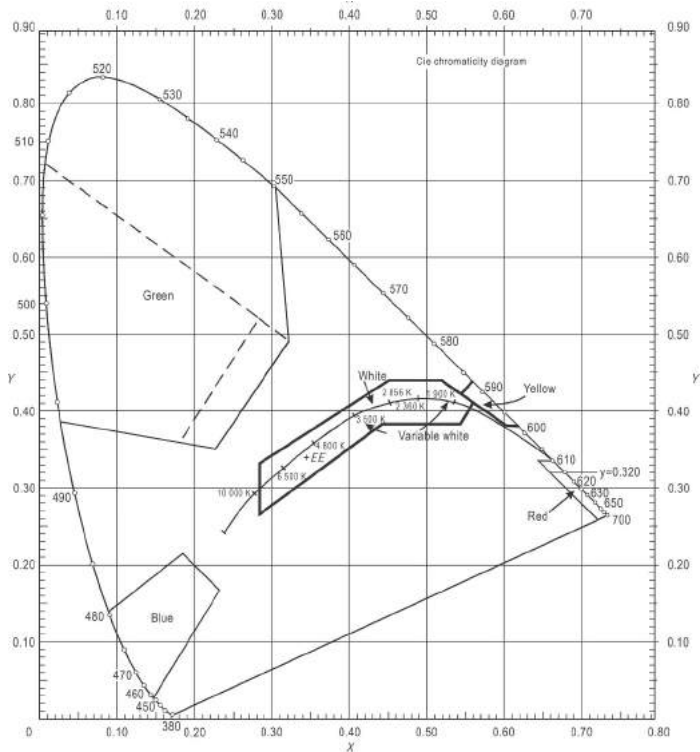
White boundary:  $y = 0.243 + 0.670x$

Blue boundary:  $y = 0.493 - 0.524x$

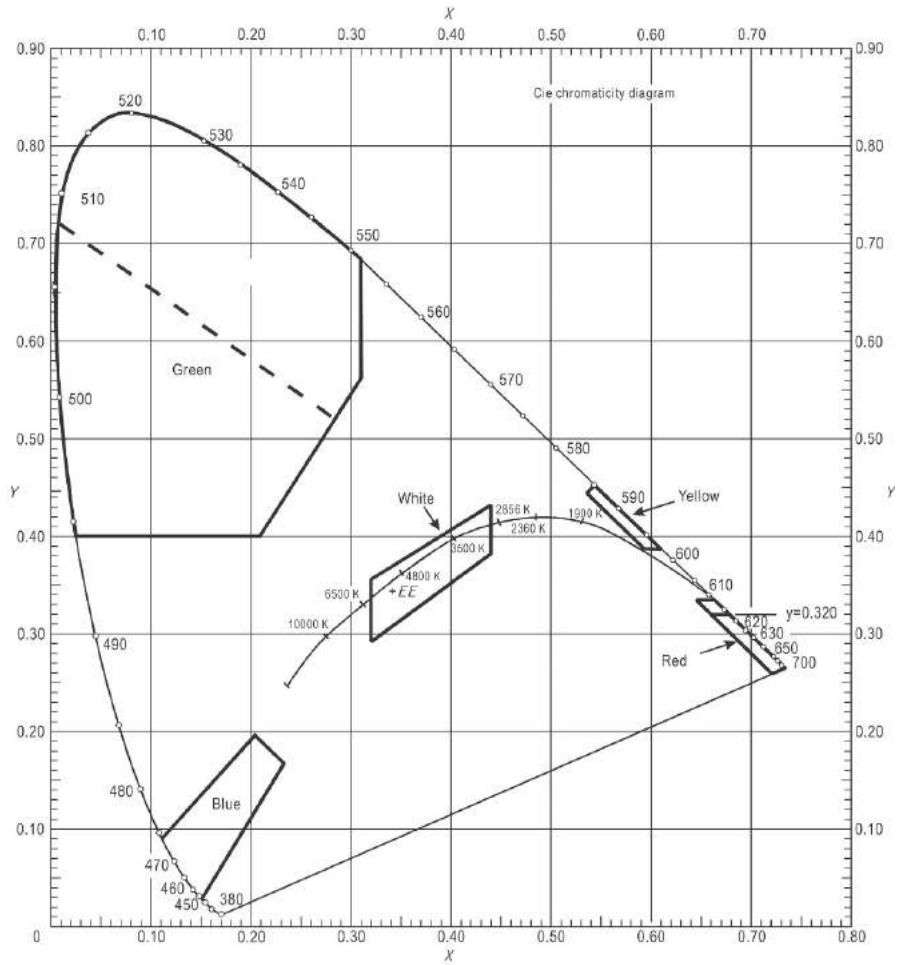
Luminance factor:  $\beta = 0.10$  minimum (day conditions)

Relative luminance: to white (night conditions)  
 5% (minimum)  
 30% (maximum)

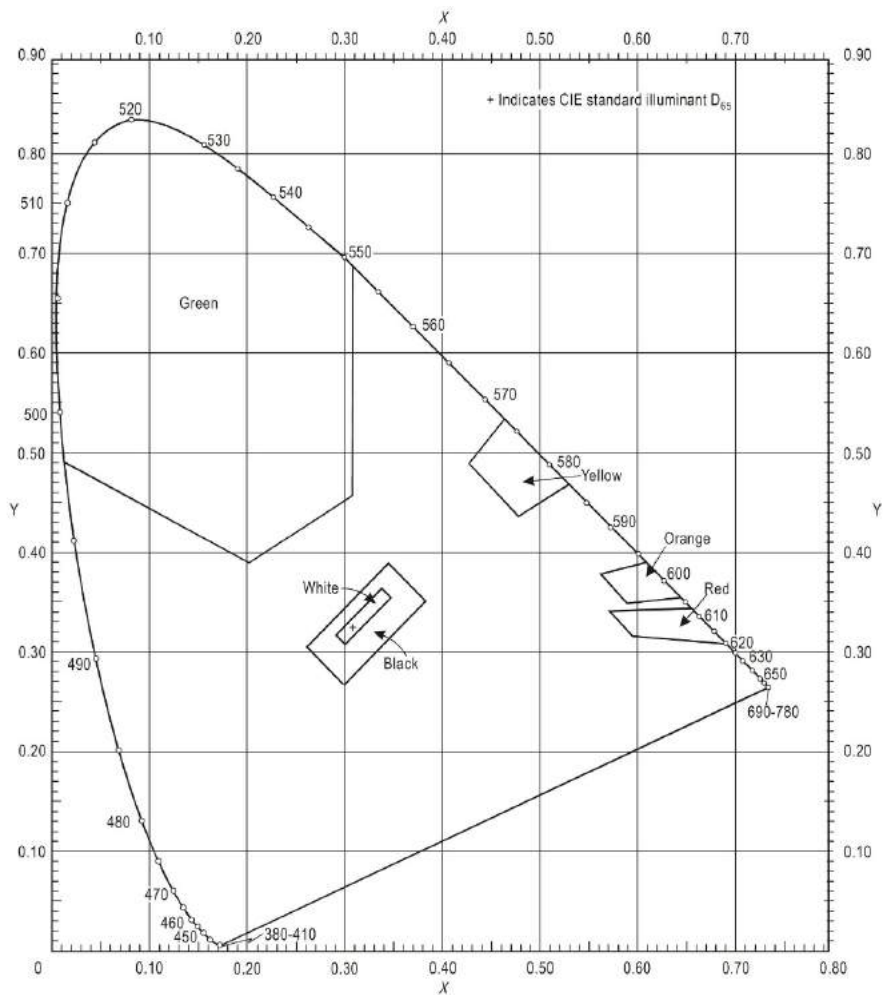
**Figure S3-1a. Colours for aeronautical ground lights (filament-type lamps)**



**Figure S3-1b. Colours for aeronautical ground lights (solid state lighting)**

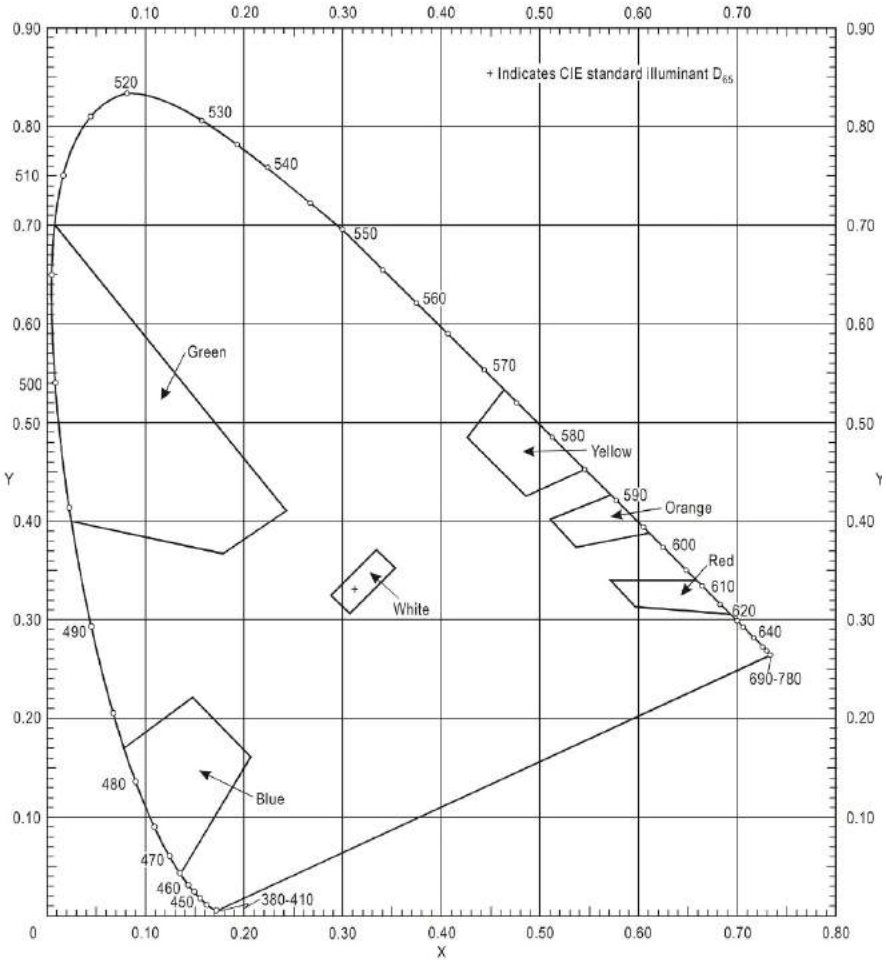


**Figure S3-2. Ordinary colours for markings and externally illuminated signs and panels**

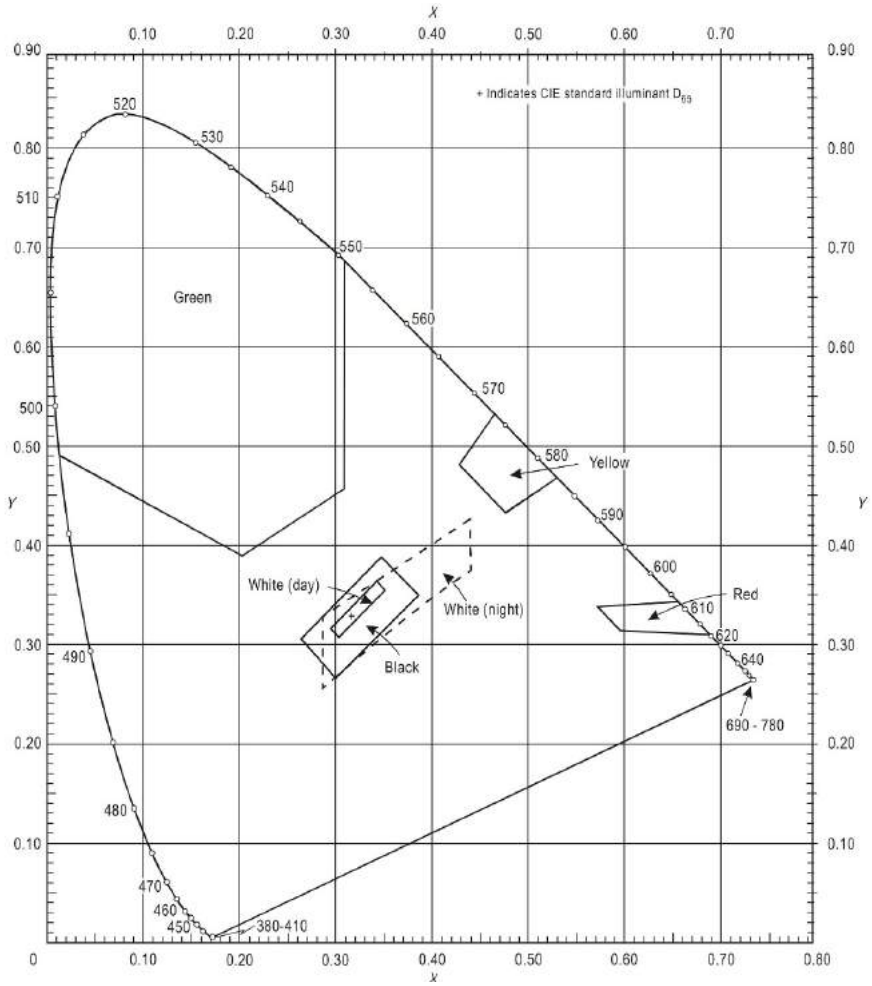




**Figure S3-3. Colours of retroreflective materials for markings, signs and panels**



**Figure S3-4. Colours of luminescent or transilluminated (internally illuminated) signs and panels**

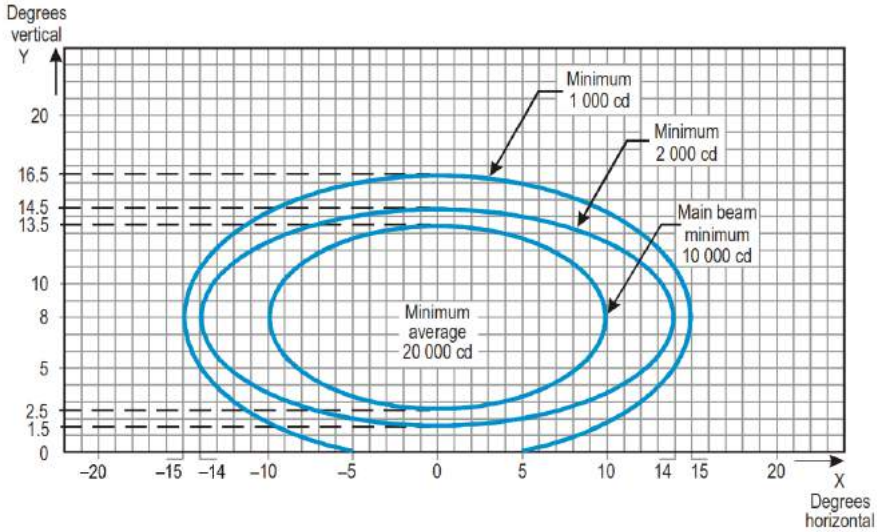


## SCHEDULE 4

*Regulations 159,166,167,  
169,175,176,177,178, 179, 180,*

*181, 183, 189,190, 191,  
193,201,282*

### AERONAUTICAL GROUND LIGHT CHARACTERISTICS



**Notes:**

- Curves calculated on formula

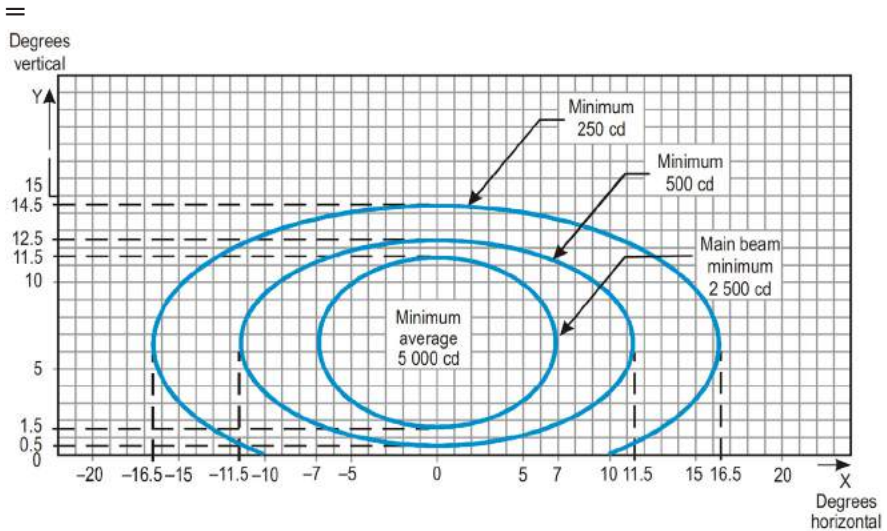
a	10	14	15
b	5.5	6.5	8.5

- Vertical setting angles of the lights shall be such that the following vertical coverage of the main beam will be met:

distance from threshold	vertical main beam coverage
threshold to 315 m	0° — 11°
316 m to 475 m	0.5° — 11.5°
476 m to 640 m	1.5° — 12.5°
641 m and beyond	2.5° — 13.5° (as illustrated above)

3. Lights in crossbars beyond 22.5 m from the centre line shall be toed-in 2 degrees. All other lights shall be aligned parallel to the centre line of the runway.
4. See collective notes for Figures S4-1 to S4-11 and S4-25.

**Figure S4-1. Isocandela diagram for approach centre line light and crossbars (white light)**



Notes:

1. Curves calculated on formula

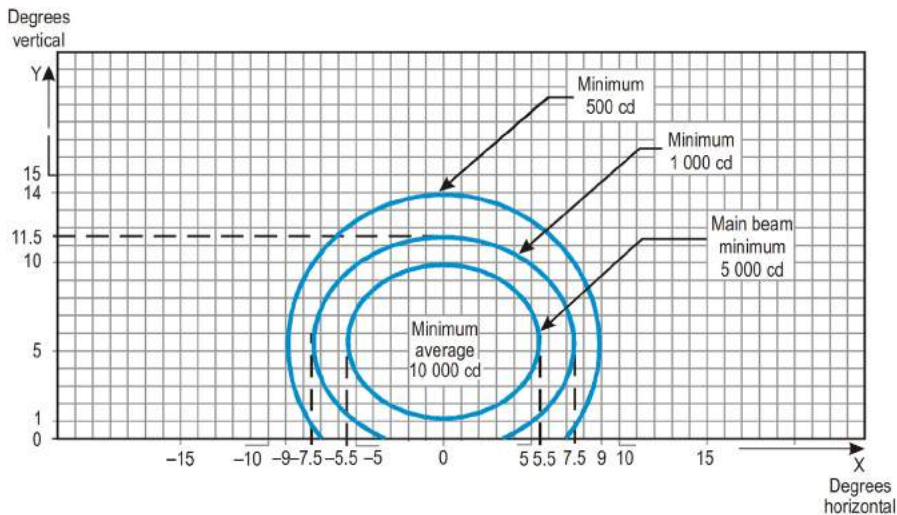
a	7.0	11.5	16.5
b	5.0	6.0	8.0

2. Toe-in 2 degrees
3. Vertical setting angles of the lights shall be such that the following vertical coverage of the main beam will be met:

distance from threshold	vertical main beam coverage
threshold to 115 m	0.5° — 10.5°
116 m to 215 m	0 1° — 11°
216 m and beyond	1.5° — 11.5° (as illustrated above)

4. See collective notes for Figures S4-1 to S4-11 and S4-25.

**Figure S4-2. Isocandela diagram for approach side row light (red light)**



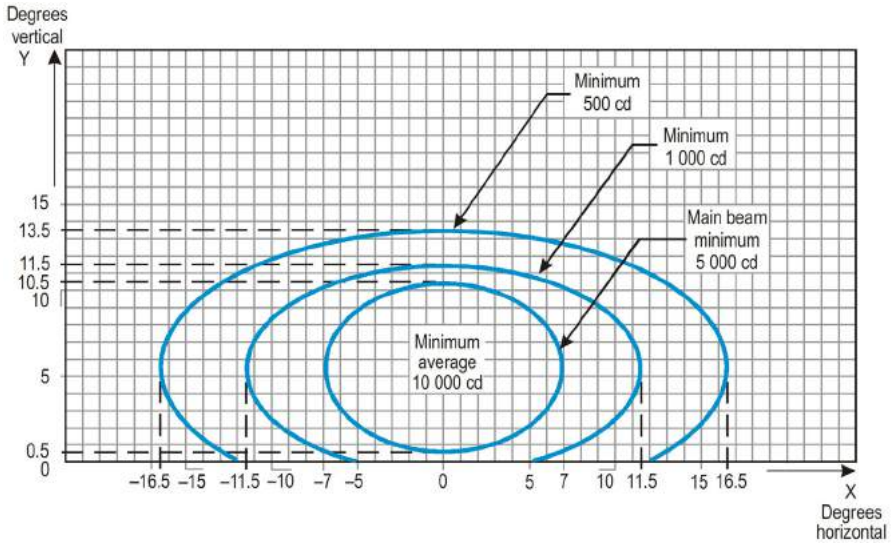
Notes:

1. Curves calculated on formula

a	5.5	7.5	9.0
b	4.5	6.0	8.5

2. Toe-in 3.5 degrees
3. See collective notes for Figures S4-1 to S4-11 and S4-25.

**Figure S4-3. Isocandela diagram for threshold light (green light)**



Notes:

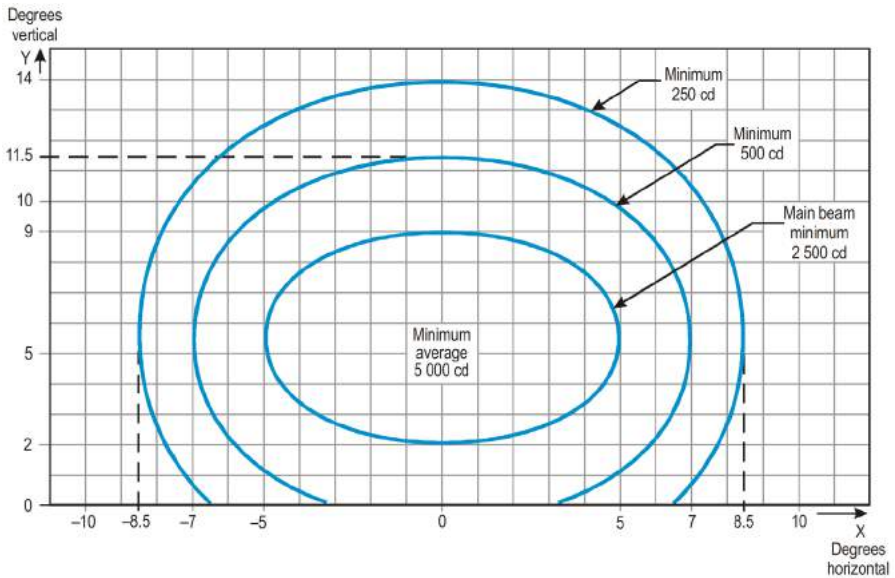
1. Curves calculated on formula

a	7.0	11.5	16.5
b	5.0	6.0	8.0

2. Toe-in 2 degrees

3. See collective notes for Figures S4-1 to S4-11 and S4-25.

**Figure S4-4. Isocandela diagram for threshold wing bar light (green light)**



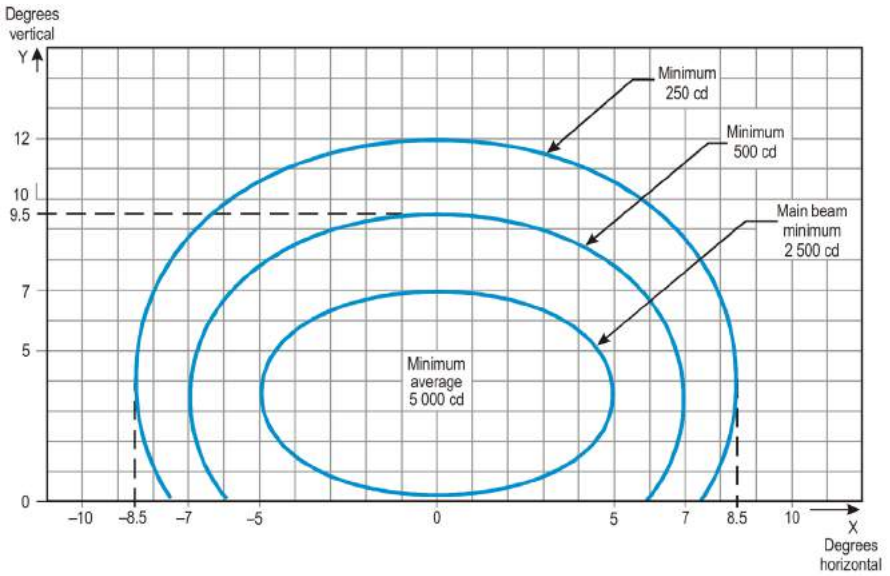
Notes:

1. Curves calculated on formula

a	5.0	7.0	8.5
b	3.5	6.0	8.5

2. Toe-in 4 degrees
3. See collective notes for Figures S4-1 to S4-11 and S4-25.

**Figure S4-5. Isocandela diagram for touchdown zone light (white light)**



Notes:

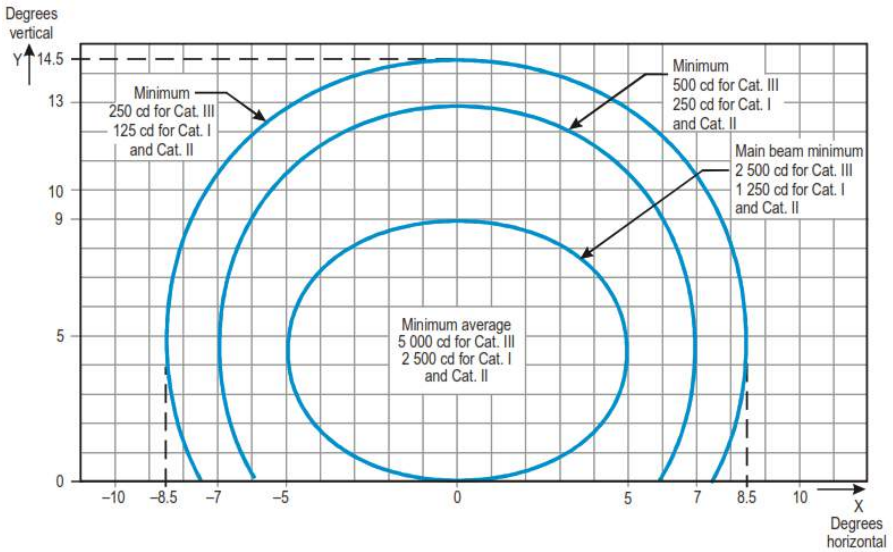
1. Curves calculated on formula  $\frac{x^2}{a^2} + \frac{y^2}{b^2} = 1$

a	5.0	7.0	8.5
b	3.5	6.0	8.5

2. For red light, multiply values by 0.15.
3. For yellow light, multiply values by 0.40.
4. See collective notes for Figures S4-1 to S4-11 and S4-25.



**Figure S4-6. Isocandela diagram for runway centre line light with 30 m longitudinal spacing (white light) and rapid exit taxiway indicator light (yellow light)**



Notes:

1. Curves calculated on formula

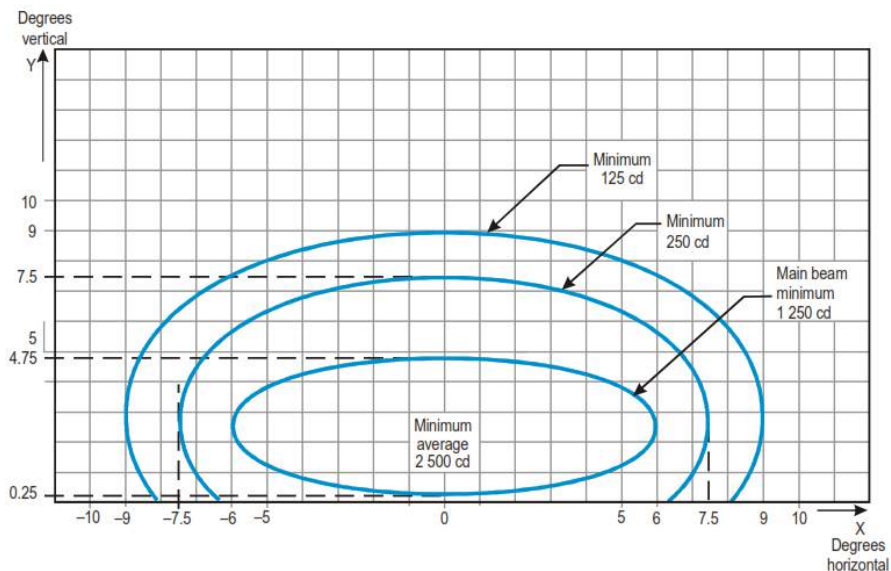
a	5.0	7.0	8.5
b	4.5	8.5	10

2. For red light, multiply values by 0.15.

3. For yellow light, multiply values by 0.40.

4. See collective notes for Figures S4-1 to S4-11 and S4-25.

**Figure S4-7. Isocandela diagram for runway centre line light with 15 m longitudinal spacing (white light) and rapid exit taxiway indicator light (yellow light)**



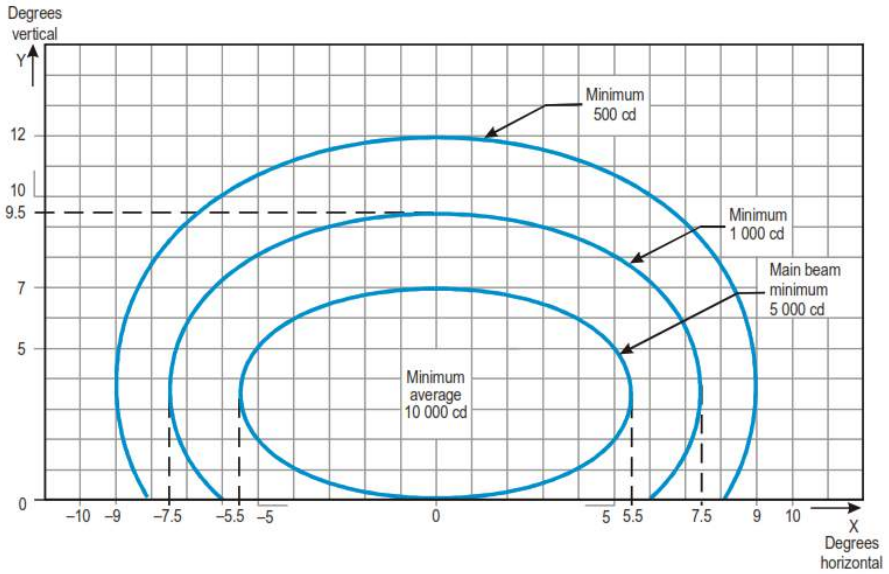
Notes:

1. Curves calculated on formula

a	7.0	11.5	16.5
b	5.0	6.0	8.0

2. See collective notes for Figures S4-1 to S4-11 and S4-25.

**Figure S4-8. Isocandela diagram for runway end light (red light)**



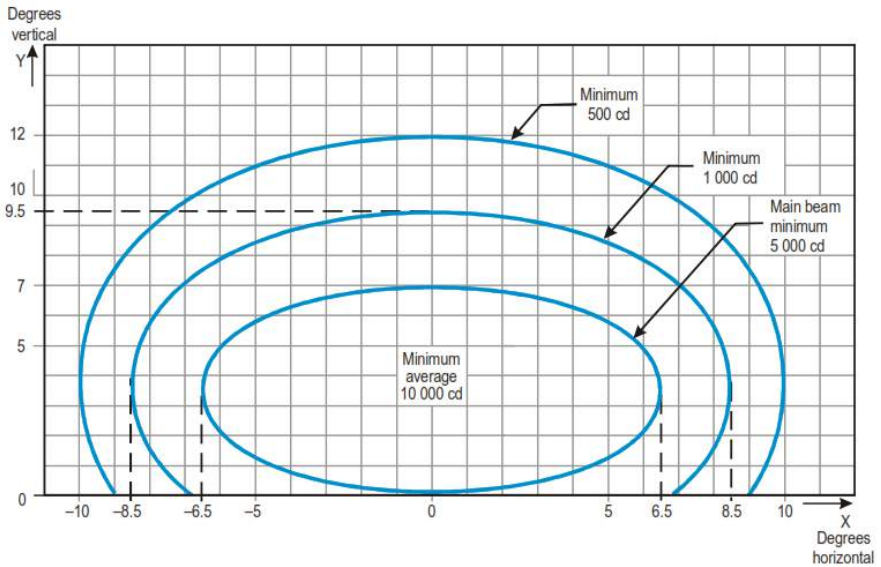
Notes:

1. Curves calculated on formula

a	5.5	7.5	9.0
b	3.5	6.0	8.5

2. Toe-in 3.5 degrees
3. For red light, multiply values by 0.15.
4. For yellow light, multiply values by 0.40.
5. See collective notes for Figures S4-1 to S4-11 and S4-25.

**Figure S4-9. Isocandela diagram for runway edge light where width of runway is 45 m (white light)**



Notes:

1. Curves calculated on formula

a	6.5	8.5	10.0
b	3.5	6.0	8.5

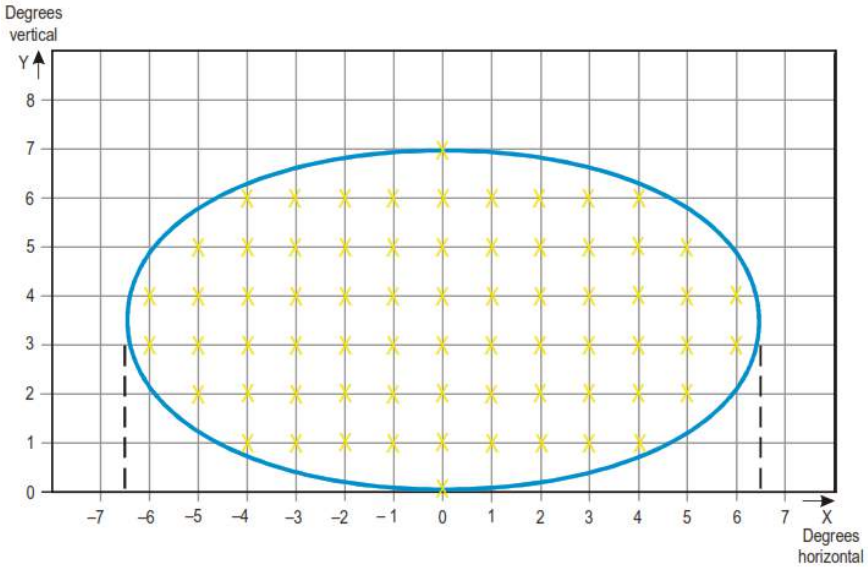
2. Toe-in 4.5 degrees

3. For red light, multiply values by 0.15.

4. For yellow light, multiply values by 0.40.

5. See collective notes for Figures S4-1 to S4-11 and S4-25.

**Figure S4-10. Isocandela diagram for runway edge light where width of runway is 60m (white light)**



**Figure S4-11. Grid points to be used for the calculation of average intensity of approach and runway lights**

Collective notes to Figures S4-1 to S4-11

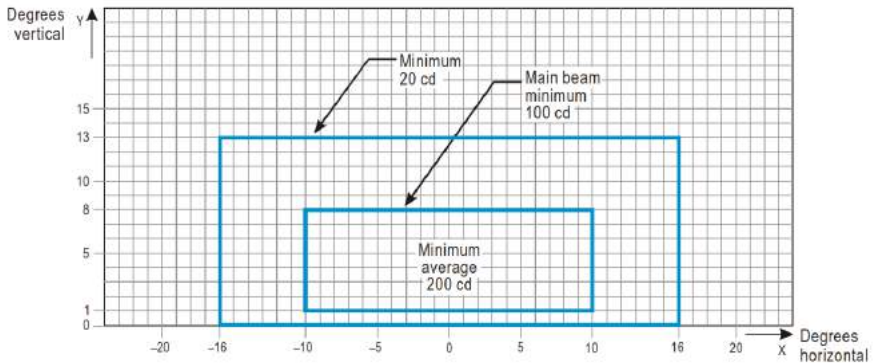
- (1) The ellipses in each figure are symmetrical about the common vertical and horizontal axes.
- (2) Figures S4-1 to S4-10 show the minimum allowable light intensities.
- (3) The average intensity of the main beam is calculated by establishing grid points as shown in Figure S4-11 and using the intensity value measures at all grid points located within and on the perimeter of the ellipse representing the main beam. The average value is the arithmetic average of light intensities measured at all considered grid points.
- (4) No deviations are acceptable in the main beam pattern when the lighting fixture is properly aimed.

- (5) Average intensity ratio. The ratio between the average intensity within the ellipse defining the main beam of a typical new light and the average light intensity of the main beam of a new runway edge light shall be as follows:

Figure S4-1	Approach centre line and crossbars	1.5 to 2.0 (white light)
Figure S4-2	Approach side row	0.5 to 1.0 (red light)
Figure S4-3	Threshold	1.0 to 1.5 (green light)
Figure S4-4	Threshold wing bar	1.0 to 1.5 (green light)
Figure S4-5	Touchdown zone	0.5 to 1.0 (white light)
Figure S4-6	Runway centre line (longitudinal spacing 30 m)	0.5 to 1.0 (white light)
Figure S4-7	Runway centre line (longitudinal spacing 15 m)	0.5 to 1.0 for CAT III
		(white light)
		0.25 to 0.5 for CAT I, II
		(white light)
Figure S4-8	Runway end	0.25 to 0.5 (red light)
Figure S4-9	Runway edge (45 m runway width)	1.0 (white light)
Figure S4-10	Runway edge (60 m runway width)	1.0 (white light)

- (6) The beam coverages in the figures provide the necessary guidance for approaches down to an RVR of the order of 150 m and take-offs down to an RVR of the order of 100 m.
- (7) Horizontal angles are measured with respect to the vertical plane through the runway centre line. For lights other than centre line lights, the direction towards the runway centre line is considered positive. Vertical angles are measured with respect to the horizontal plane.

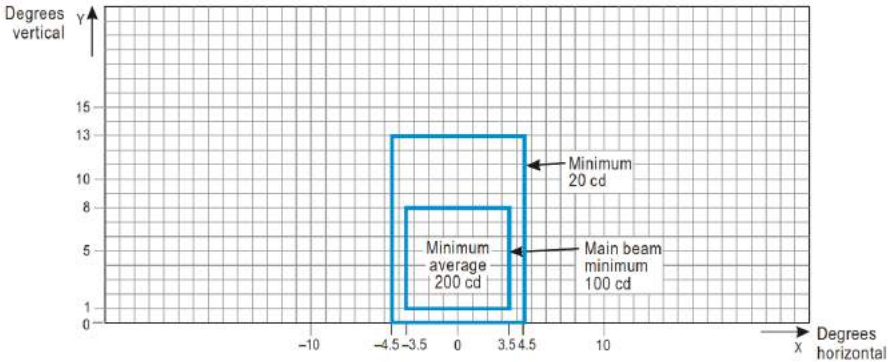
- (8) Where, for approach centre line lights and crossbars and for approach side row lights, inset lights are used in lieu of elevated lights, e.g. on a runway with a displaced threshold, the intensity requirements can be met by installing two or three fittings (lower intensity) at each position.
- (9) The importance of adequate maintenance cannot be over emphasised. The average intensity shall never fall to a value less than 50 per cent of the value shown in the figures, and it shall be the aim of airport authorities to maintain a level of light output close to the specified minimum average intensity.
- (10) The light unit shall be installed so that the main beam is aligned within one-half degree of the specified requirement.



Notes:

1. These beam coverages allow for displacement of the cockpit from the centre line up to distances of the order of 12 m and are intended for use before and after curves.
2. See collective notes for Figures A2-12 to A2-21.
3. Increased intensities for enhanced rapid exit taxiway centre line lights as recommended in Regulation 183 (13) are four times the respective intensities in the figure (i.e. 800 cd for minimum average main beam).

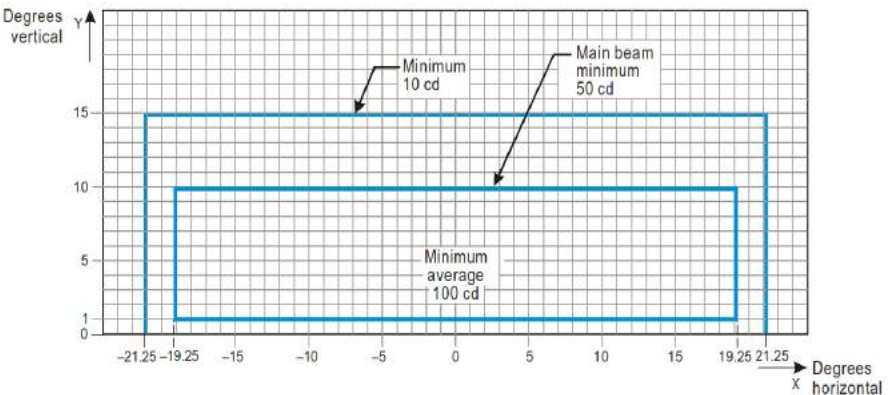
**Figure S4-12. Isocandela diagram for taxiway centre line (15 m spacing), no- entry bar and stop bar lights in straight sections intended for use in runway visual range conditions of less than a value of 350 m where large offsets can occur and for low-intensity runway guard lights, Configuration B**



Notes:

1. These beam coverages are generally satisfactory and cater for a normal displacement of the cockpit from the centre line of approximately 3 m.
2. See collective notes for Figures S4-12 to S4-21.

**Figure S4-13. Isocandela diagram for taxiway centre line (15 m spacing), no- entry bar and stop bar lights in straight sections intended for use in runway visual range conditions of less than a value of 350 m**

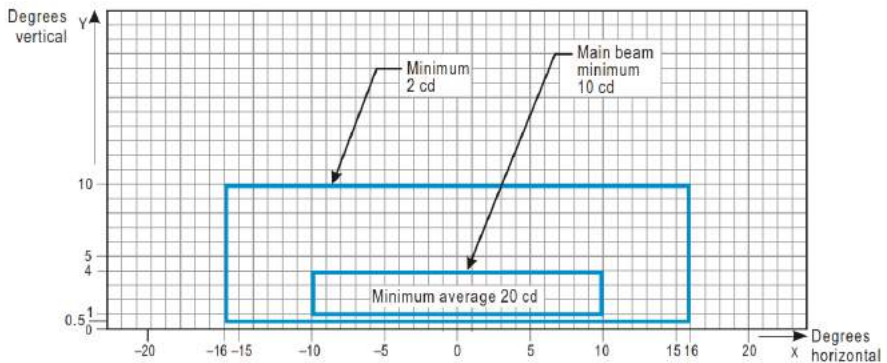




Notes:

1. Lights on curves to be toed-in 15.75 degrees with respect to the tangent of the curve.  
This does not apply to runway entrance lights (RELs)
2. Increased intensities for RELs shall be twice the specified intensities, i.e., minimum 20 cd, main beam minimum 100 cd and minimum average 200 cd.
3. See collective notes for Figures S4-12 to S4-21.

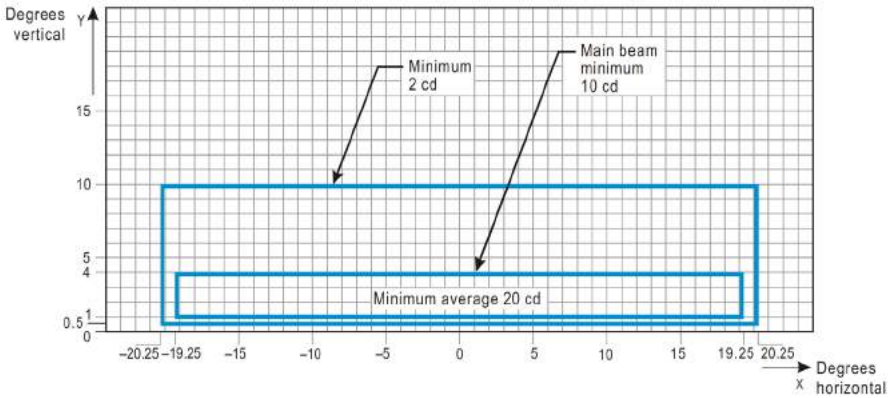
**Figure S4-14. Isocandela diagram for taxiway centre line (7.5 m spacing), no- entry bar and stop bar lights in curved sections intended for use in runway visual range conditions of less than a value of 350 m**



Notes:

1. At locations where high background luminance is usual and where deterioration of light output resulting from dust and local contamination is a significant factor, the cd-values should be multiplied by 2.5.
2. Where omnidirectional lights are used they shall comply with the vertical beam requirements in this figure.
3. See collective notes for Figures S4 -12 to S4 -21.

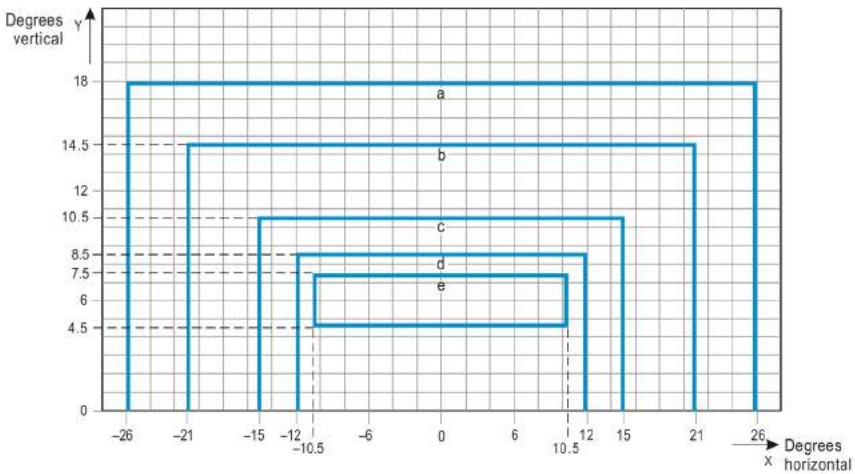
**Figure S4-15. Isocandela diagram for taxiway centre line (30 m, 60 m spacing), no-entry bar and stop bar lights in straight sections intended for use in runway visual range conditions of 350 m or greater**



Notes:

1. Lights on curves to be toed-in 15.75 degrees with respect to the tangent of the curve.
2. At locations where high background luminance is usual and where deterioration of light output resulting from dust and local contamination is a significant factor, the cd-values should be multiplied by 2.5.
3. These beam coverages allow for displacement of the cockpit from the centre line up to distances of the order of 12 m as could occur at the end of curves.
4. See collective notes for Figures S4-12 to S4-21.

**Figure S4-16. Isocandela diagram for taxiway centre line (7.5 m, 15 m, 30 m spacing), no-entry bar and stop bar lights in curved sections intended for use in runway visual range conditions of 350 m or greater**

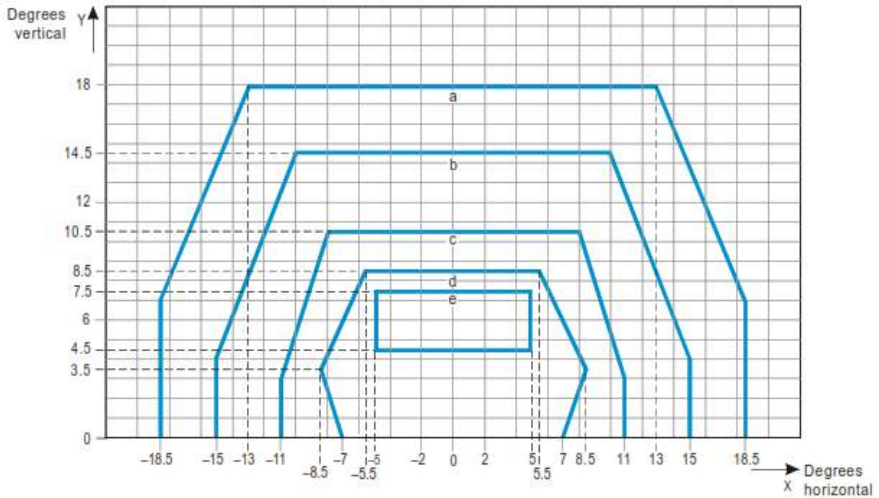


Curve	a	b	c	d	e
Intensity (cd)	8	20	100	450	1 800

Notes:

1. These beam coverages allow for displacement of the cockpit from the centre line up to distances of the order of 12 m and are intended for use before and after curves.
2. See collective notes for Figures S4-12 to S4-21.

**Figure S4-17. Isocandela diagram for high-intensity taxiway centre line (15 m spacing), no-entry bar and stop bar lights in straight sections intended for use in an advanced surface movement guidance and control system where higher lightintensities are required and where large offsets can occur**

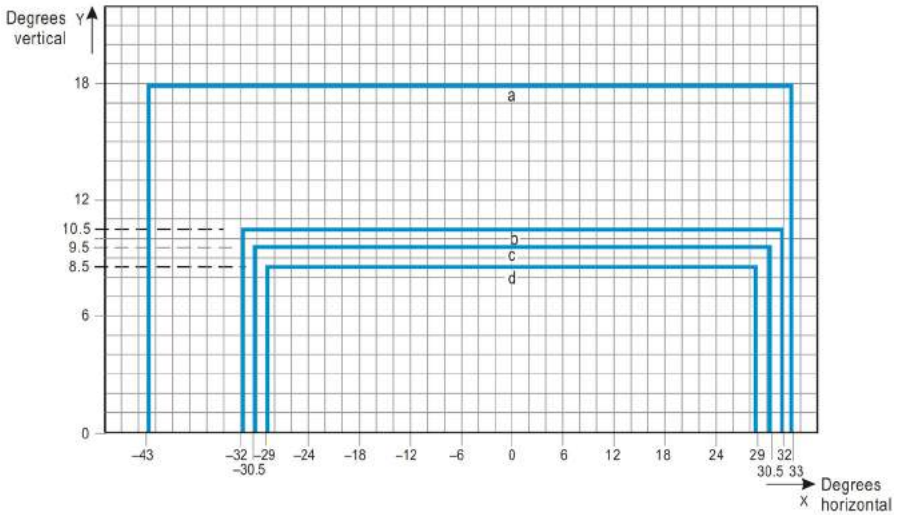


Curve	a	b	c	d	e
Intensity (cd)	8	20	100	450	1 800

Notes:

1. These beam coverages are generally satisfactory and cater for a normal displacement of the cockpit corresponding to the outer main gear wheel on the taxiway edge.
2. See collective notes for Figures S4-12 to S4-21.

**Figure S4-18. Isocandela diagram for high-intensity taxiway centre line (15 m spacing), no-entry bar and stop bar lights in straight sections intended for use in an advanced surface movement guidance and control system where higher light intensities are required**

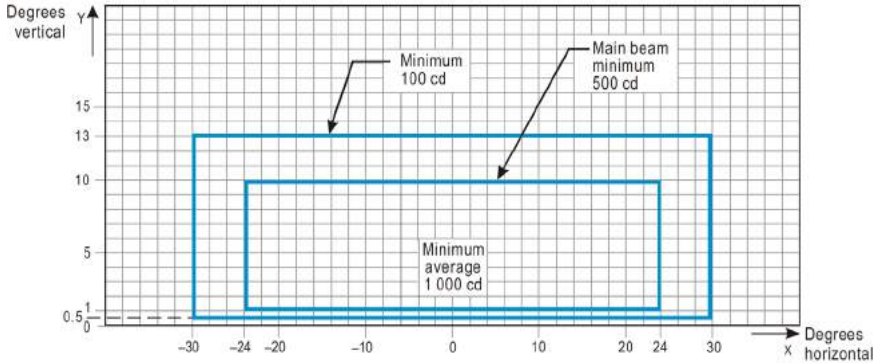


Curve	a	b	c	d
Intensity (cd)	8	100	200	400

Notes:

- Lights on curves to be toed-in 17 degrees with respect to the tangent of the curve.
- See collective notes for Figures S4-12 to S4 -21.

**Figure S4-19. Isocandela diagram for high-intensity taxiway centre line (7.5 m spacing), no-entry bar and stop bar lights in curved sections intended for use in an advanced surface movement guidance and control system where higher lightintensities are required.**



Notes:

1. Although the lights flash in normal operation, the light intensity is specified as if the lights were fixed for incandescent lamps.
2. See collective notes for Figures S4-12 to S4-21.

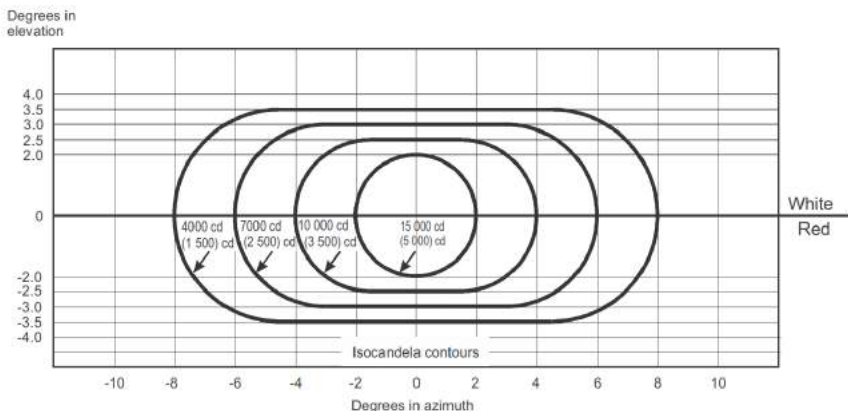
**Figure S4-20. Isocandela diagram for high-intensity runway guard lights, Configuration B**



***Figure S4-21. Grid points to be used for calculation of average intensity of taxiway centre line and stop bar lights***

Collective notes to Figures S4-12 to S4-21

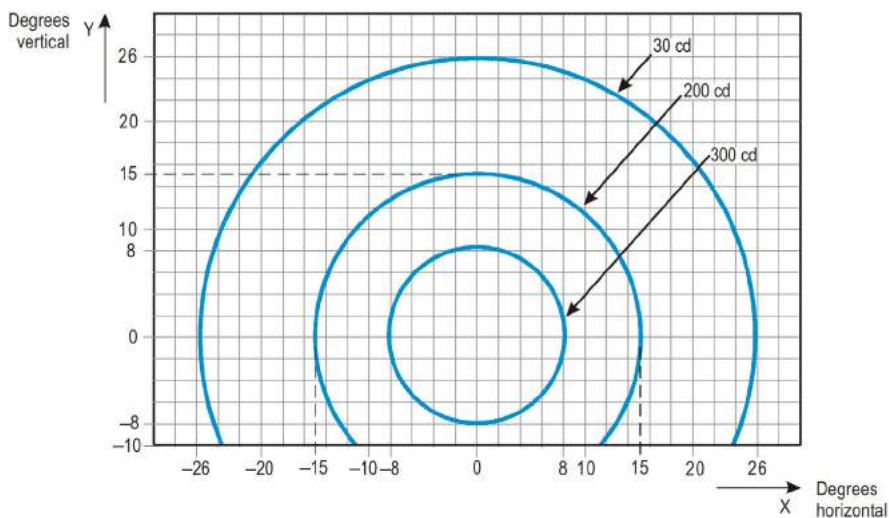
- (1) The intensities specified in Figures S4-12 to S4-20 are in green and yellow light for taxiway centre line lights, yellow light for runway guard lights and red light for stop bar lights.
- (2) Figures S4-12 to S4-20 show the minimum allowable light intensities. The average intensity of the main beam is calculated by establishing grid points as shown in Figure S4-21 and using the intensity values measured at all grid points located within and on the perimeter of the rectangle representing the main beam. The average value is the arithmetic average of the light intensities measured at all considered grid points.
- (3) No deviations are acceptable in the main beam or in the innermost beam, as applicable, when the lighting fixture is properly aimed.
- (4) Horizontal angles are measured with respect to the vertical plane through the taxiway centre line except on curves where they are measured with respect to the tangent to the curve.
- (5) Vertical angles are measured from the longitudinal slope of the taxiway surface.
- (6) The importance of adequate maintenance cannot be over emphasised. The intensity, either average where applicable or as specified on the corresponding isocandela curves, shall never fall to a value less than 50 per cent of the value shown in the figures, and it shall be the aim of airport authorities to maintain a level of light output close to the specified minimum average intensity.
- (7) The light unit shall be installed so that the main beam or the innermost beam, as applicable, is aligned within one-half degree of the specified requirement.



Notes:

1. These curves are for minimum intensities in red light.
2. The intensity value in the white sector of the beam is no less than 2 and may be as high as 6.5 times the corresponding intensity in the red sector.
3. The intensity values shown in brackets are for APAPI.

**Figure S4-22. Light intensity distribution of PAPI and APAPI**

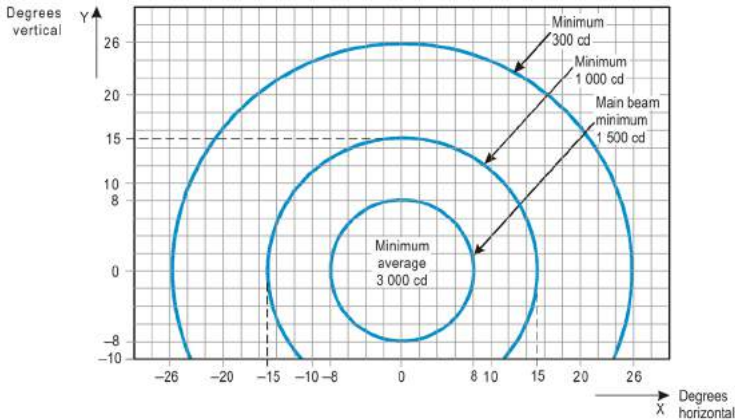


Notes:

1. Although the lights flash in normal operation, the light intensity is specified as if the lights were fixed for incandescent lamps.
2. The intensities specified are in yellow light.



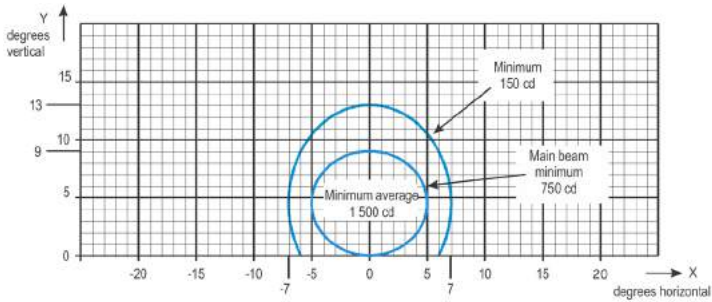
**Figure A2-23. Isocandela diagram for each light in low-intensity runway guard lights, Configuration A**



Notes:

1. Although the lights flash in normal operation, the light intensity is specified as if the lights were fixed for incandescent lamps.
2. The intensities specified are in yellow light.

**Figure S4-24. Isocandela diagram for each light in high-intensity runway guard lights, Configuration A**



Notes:

1. Curves calculated on formula

a	5.0	7.0
b	4.5	8.5

2. See collective notes for Figures S4-1 to S4-11 and S4-25.

**Figure S4-25. Isocandela diagram for take-off and hold lights (THL) (red light)**

## SCHEDULE 5

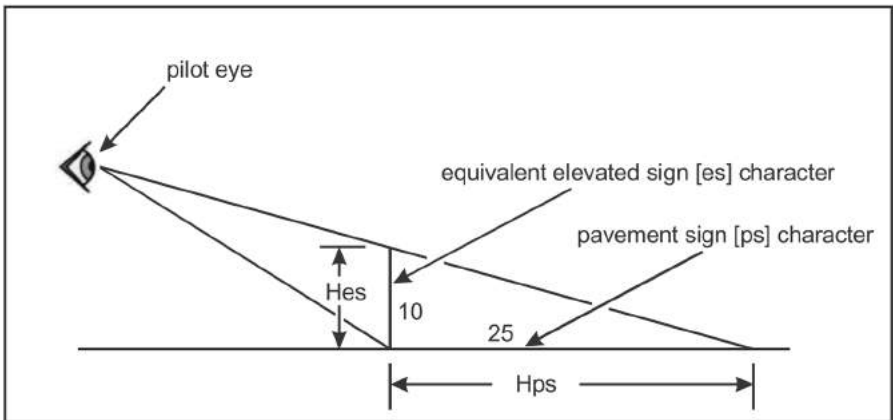
*Regulations 150, 151*

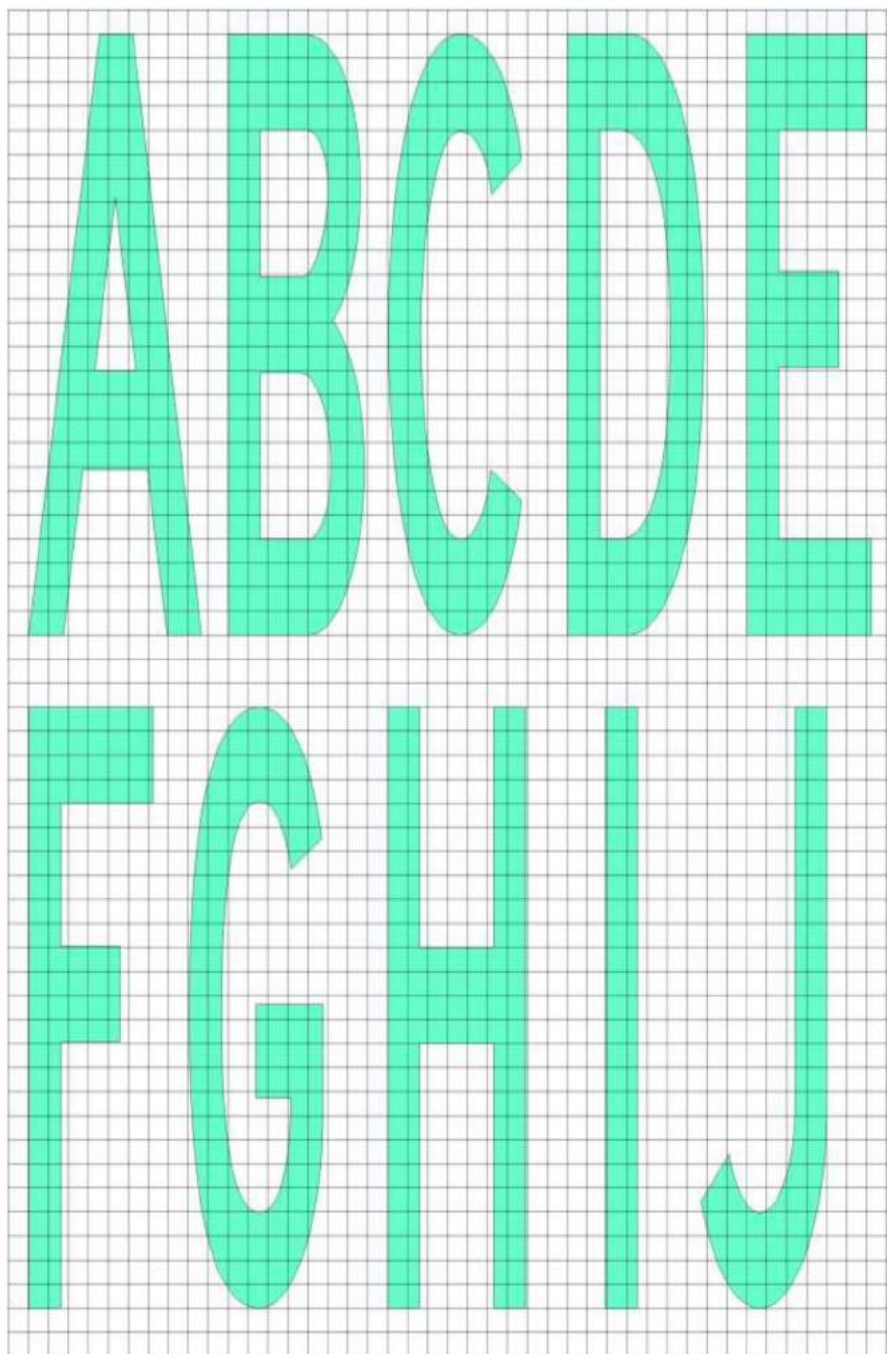
### MANDATORY INSTRUCTION MARKINGS AND INFORMATION MARKINGS

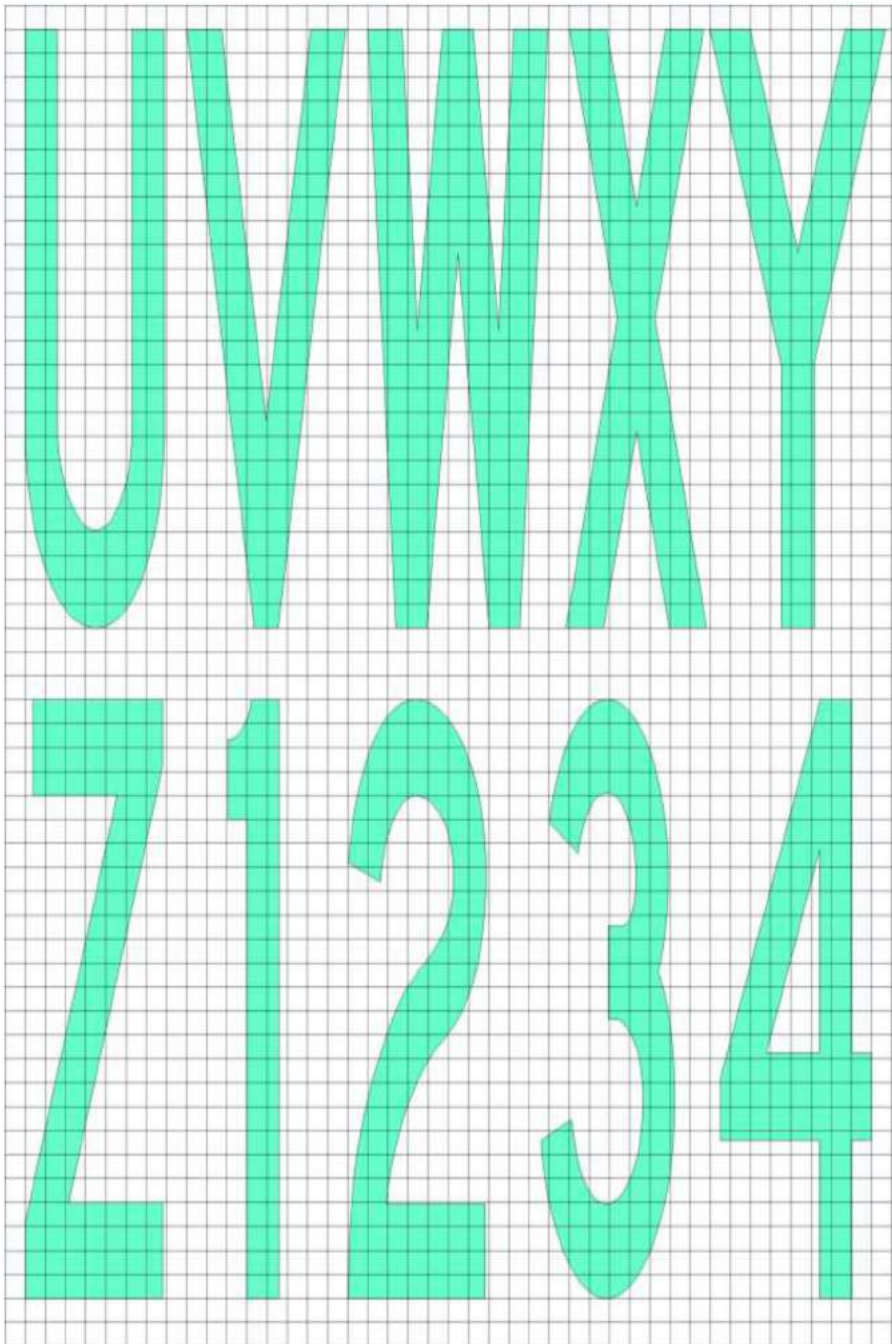
Note 1 — See Part X, regulation 150 and 151 for specifications on the application, location and characteristics of mandatory instruction markings and information markings.

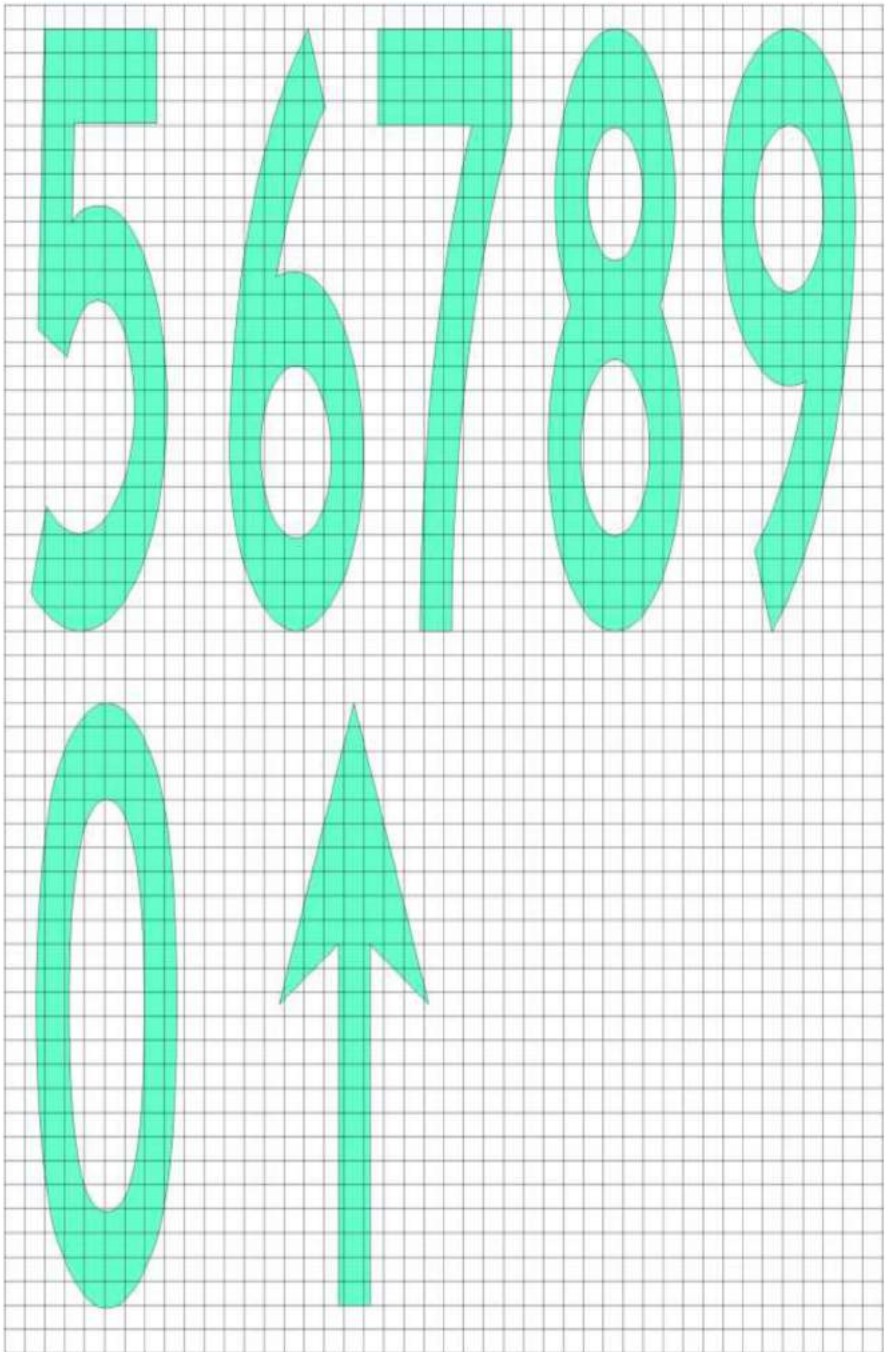
Note 2— This Schedule details the form and proportions of the letters, numbers and symbols of mandatory instruction markings and information markings on a 20 cm grid.

**Figure S5-1**









## SCHEDULE 6

*Regulation 202*

### REQUIREMENTS CONCERNING DESIGN OF TAXIING GUIDANCE SIGNS

Note — See Part X, regulation 202, for specifications on the application, location and characteristics of signs.

- Inscription heights shall conform to the following tabulation.

Runway code number	Minimum character height		
	Mandatory instruction sign	Information sign	
		Runway exit and runway vacated signs	Other signs
1 or 2	300 mm	300 mm	200 mm
3 or 4	400 mm	400 mm	300 mm

Note.— Where a taxiway location sign is installed in conjunction with a runway designation sign, the character size shall be that specified for mandatory instruction signs.

- Arrow dimensions shall be as follows:

Legend height	Stroke
200 mm	32 mm
300 mm	48 mm
400 mm	64 mm

- Stroke width for single letter shall be as follows:

Legend height	Stroke
200 mm	32 mm
300 mm	48 mm
400 mm	64 mm

4. Sign luminance shall be as follows:

(1) Where operations are conducted in runway visual range conditions less than a value of 800m, average sign luminance shall be at least:

Red	30 cd/m <sup>2</sup>
Yellow	150 cd/m <sup>2</sup>
White	300 cd/m <sup>2</sup>

(2) Where operations are conducted in accordance with regulation 202 (9) (b) and (10) and (10) average sign luminance shall be at least—

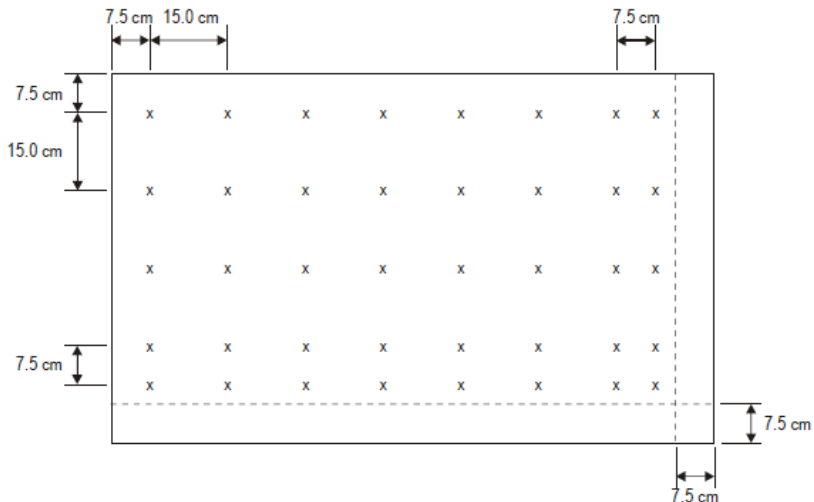
Red	10 cd/m <sup>2</sup>
Yellow	50 cd/m <sup>2</sup>
White	100 cd/m <sup>2</sup>

Note.— In runway visual range conditions less than a value of 400 m, there will be some degradation in the performance of signs.

5. The luminance ratio between red and white elements of a mandatory sign shall be between 1:5 and 1:10.
6. The average luminance of the sign is calculated by establishing grid points as shown in Figure S6-1 and using the luminance values measured at all grid points located within the rectangle representing the sign.
7. The average value is the arithmetic average of the luminance values measured at all considered grid points.
8. The ratio between luminance values of adjacent grid points shall not exceed 1.5:1. For areas on the sign face where the grid spacing is 7.5 cm, the ratio between luminance values of adjacent grid points shall not exceed 1.25:1. The ratio between the maximum and minimum luminance value over the whole sign face shall not exceed 5:1.
9. The forms of characters, i.e. letters, numbers, arrows and symbols, shall conform to those shown in Figure S6-2. The width of characters and the space between individual characters shall be determined as indicated in Table S6-1.

10. The face height of signs shall be as follows:
- | Legend height | Face height (min) |
|---------------|-------------------|
| 200 mm        | 300 mm            |
| 300 mm        | 450 mm            |
| 400 mm        | 600 mm            |
11. The face width of signs shall be determined using Figure S6-3 except that, where a mandatory instruction sign is provided on one side of a taxiway only, the face width shall not be less than:
- (1) 1.94 m where the code number is 3 or 4; and
  - (2) 1.46 m where the code number is 1 or 2.
12. Borders
- (1) The black vertical delineator between adjacent direction signs shall have a width of approximately 0.7 of the stroke width.
  - (2) The yellow border on a stand-alone location sign shall be approximately 0.5 stroke width.
13. The colours of signs shall be in accordance with the appropriate specifications in Schedule 3.

**Figure S6-1. Grid points for calculating average luminance of a sign**





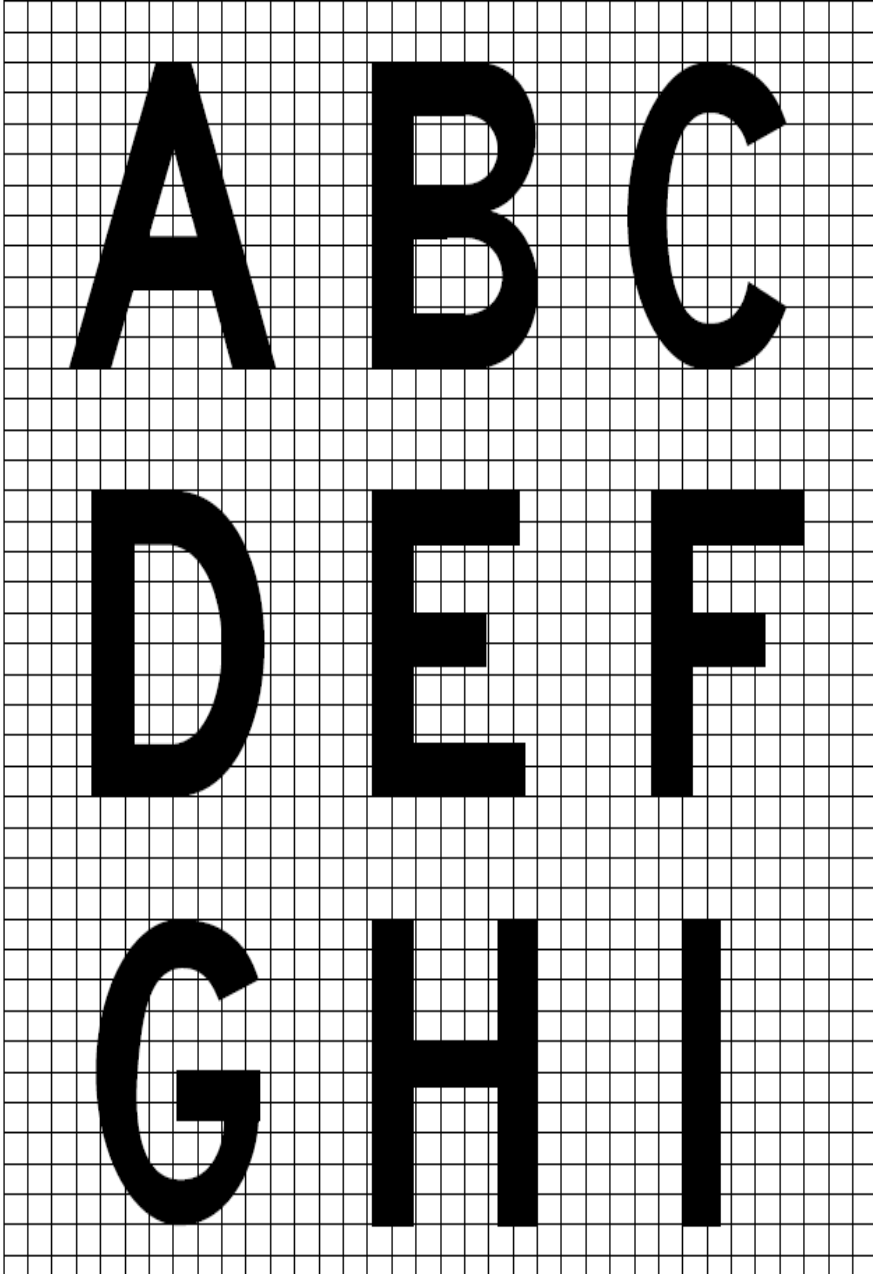
Note 1— The average luminance of a sign is calculated by establishing grid points on a sign face showing typical inscriptions and a background of the appropriate colour (red for mandatory instruction signs and yellow for direction and destination signs) as follows:

- (a) Starting at the top left corner of the sign face, establish a reference grid point at 7.5 cm from the left edge and the top of the sign face.
- (b) Create a grid of 15 cm spacing horizontally and vertically from the reference grid point. Grid points within 7.5 cm of the edge of the sign face shall be excluded.
- (c) Where the last point in a row/column of grid points is located between 22.5 cm and 15 cm from the edge of the sign face (but not inclusive), an additional point shall be added 7.5 cm from this point.
- (d) Where a grid point falls on the boundary of a character and the background, the grid point shall be slightly shifted to be completely outside the character.

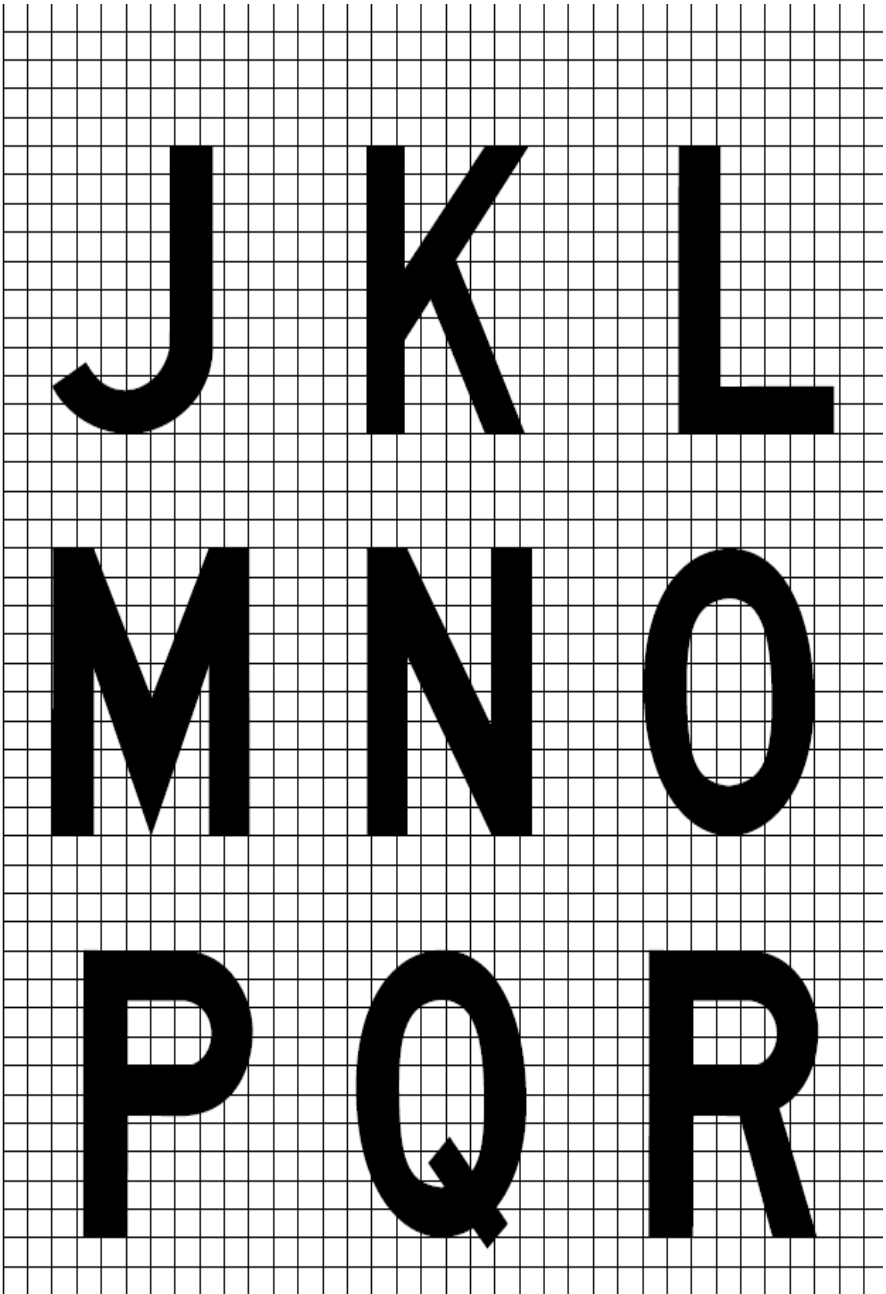
Note 2— Additional grid points may be required to ensure that each character includes at least five evenly spaced grid points.

Note 3— Where one unit includes two types of signs, a separate grid shall be established for each type.

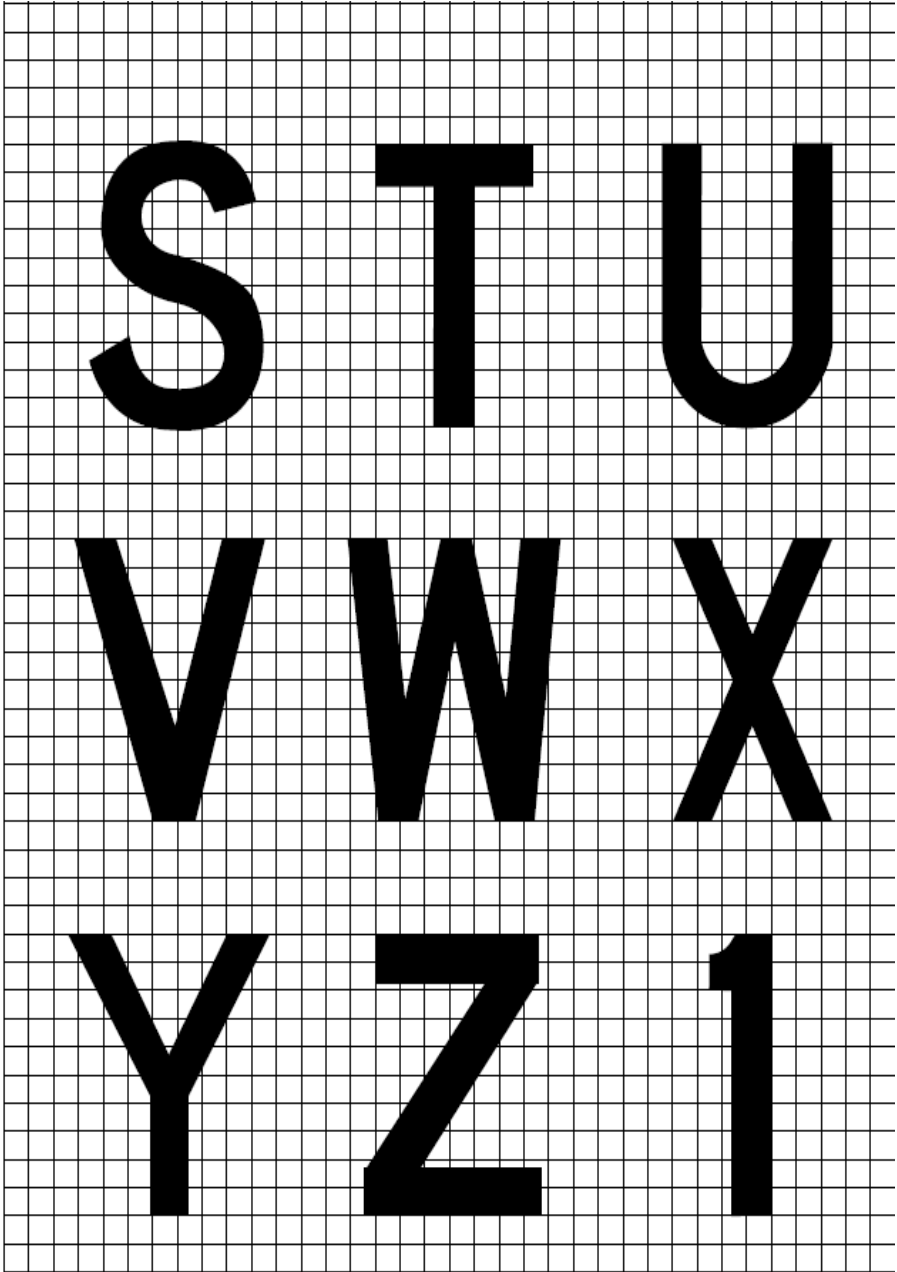
*Figure S6-2. Forms of characters*



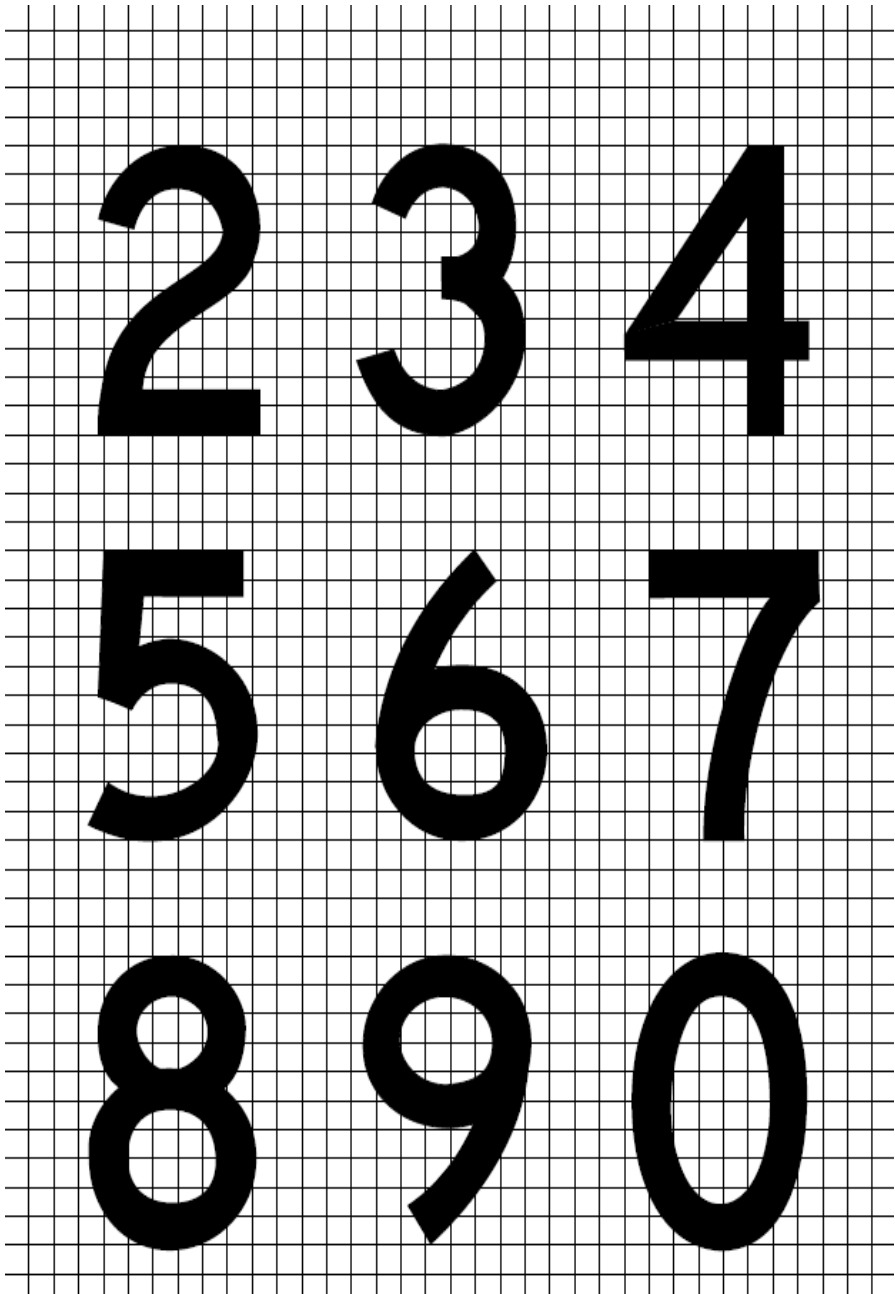
*Figure S6-2. Forms of characters (cont.)*



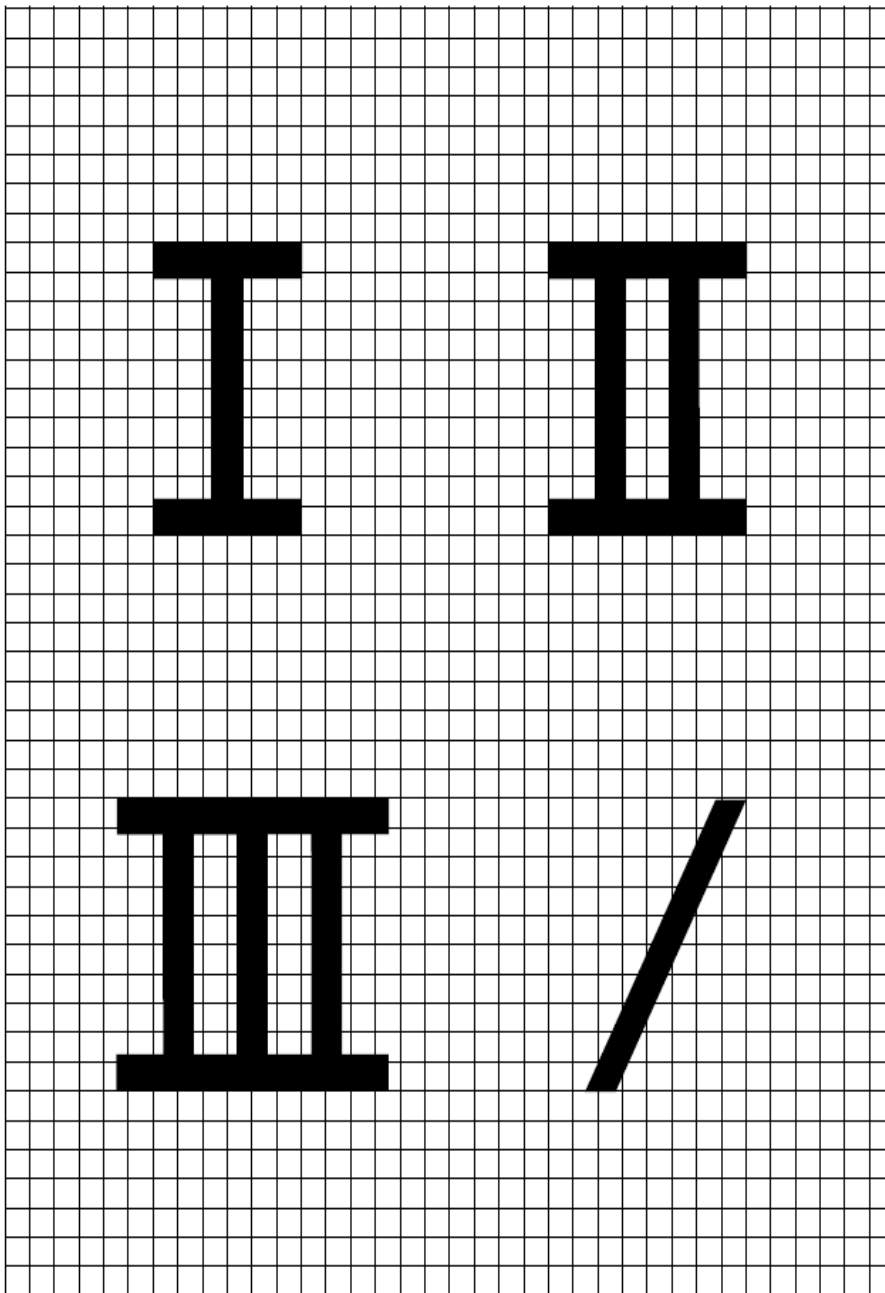
*Figure S6-2. Forms of characters (cont.)*



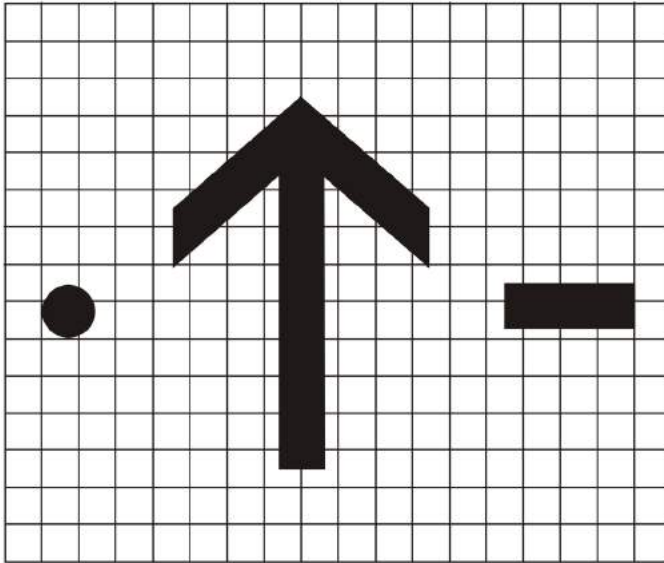
*Figure S6-2. Forms of characters (cont.)*



*Figure S6-2. Forms of characters (cont.)*



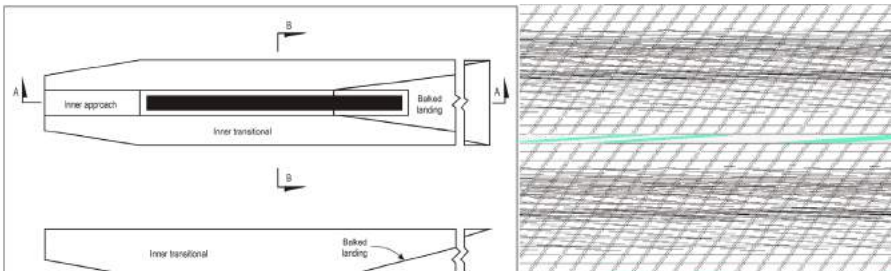
**Arrow, dot and dash**  
**Figure A4-2. Forms of characters (cont.)**



Note 1—The arrow stroke width, diameter of the dot, and both width and length of the dash shall be proportioned to the character stroke widths.

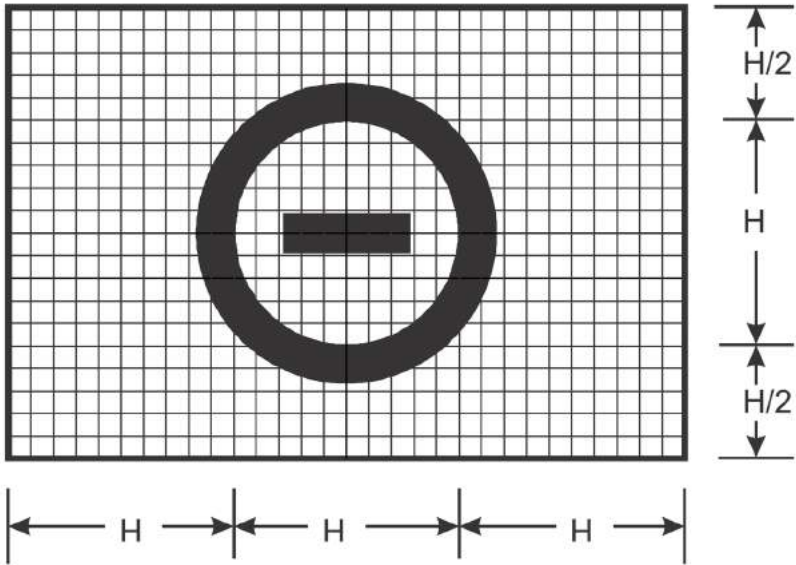
Note 2— The dimensions of the arrow shall remain constant for a particular sign size, regardless of orientation.

**Runway vacated sign (with typical location sign)**

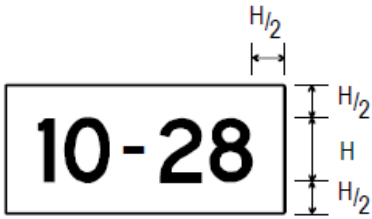


**NO ENTRY sign**

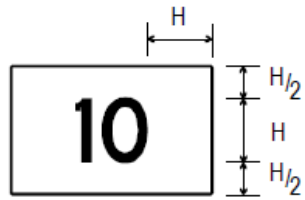
**Figure S6-3. Runway vacated and NO ENTRY signs**



*Figure S6-3. Sign dimensions*



A. Sign with two runway designators



B. Sign with one runway designator



Table S6-1. Letter and numeral widths and space between letters or numerals

a) Letter to letter code number				
Preceding Letter	Following Letter			
	B, D, E, F, H, I, K, L, M, N, P, R, U	C, G, O, Q, S, X, Z	A, J, T, V, W, Y	
	Code number			
A	2	2	4	
B	1	2	2	
C	2	2	3	
D	1	2	2	
E	2	2	3	
F	2	2	3	
G	1	2	2	
H	1	1	2	
I	1	1	2	
J	1	1	2	
K	2	2	3	
L	2	2	4	
M	1	1	2	
N	1	1	2	
O	1	2	2	
P	1	2	2	
Q	1	2	2	
R	1	2	2	
S	1	2	2	
T	2	2	4	
U	1	1	2	
V	2	2	4	
W	2	2	4	
X	2	2	3	
Y	2	2	4	
Z	2	2	3	

b) Numeral to numeral code number				
Preceding Numeral	Following number			
	1, 5	2, 3, 6, 8, 9, 0	4, 7	
	Code number			
1	1	1	2	
2	1	2	2	
3	1	2	2	
4	2	2	4	
5	1	2	2	
6	1	2	2	
7	2	2	4	
8	1	2	2	
9	1	2	2	
0	1	2	2	

c) Space between characters				
Code No.	Letter Height (mm)			
	200	300	400	
	Space (mm)			
1	48	71	96	
2	38	57	76	
3	25	38	50	
4	13	19	26	

d) Width of letter				
Letter	Letter height (mm)			
	200	300	400	
	Width (mm)			
A	170	255	340	
B	137	205	274	
C	137	205	274	
D	137	205	274	
E	124	186	248	
F	124	186	248	
G	137	205	274	
H	137	205	274	
I	32	48	64	
J	127	190	254	
K	140	210	280	
L	124	186	248	
M	157	236	314	
N	137	205	274	
O	143	214	286	
P	137	205	274	
Q	143	214	286	
R	137	205	274	
S	137	205	274	
T	124	186	248	
U	137	205	274	
V	152	229	304	
W	178	267	356	
X	137	205	274	
Y	171	257	342	
Z	137	205	274	

e) Width of numeral				
Letter	Numeral height (mm)			
	200	300	400	
	Width (mm)			
1	50	74	98	
2	137	205	274	
3	137	205	274	
4	149	224	298	
5	137	205	274	
6	137	205	274	
7	137	205	274	
8	137	205	274	
9	137	205	274	
0	143	214	286	

INSTRUCTIONS

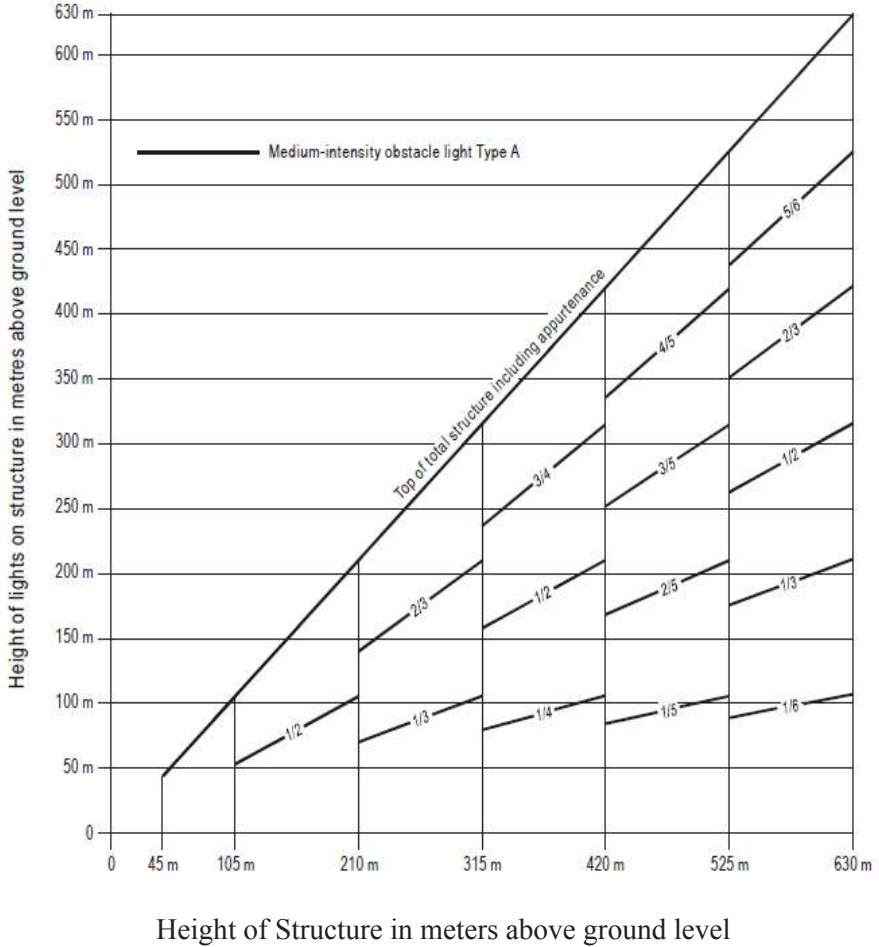
- To determine the proper SPACE between letters or numerals, obtain the code number from table a or b and enter table c for that code number to the desired letter or numeral height.
- The space between words or groups of characters forming an abbreviation or symbol should be equal to 0.5 to 0.75 of the height of the characters used except that where an arrow is located with a single character such as 'A →', the space may be reduced to not less than one quarter of the height of the character in order to provide a good visual balance.
- Where the numeral follows a letter or vice versa use Code 1.
- Where a hyphen, dot, or diagonal stroke follows a character or vice versa use Code 1.

# SCHEDULE 7

Regulation 223

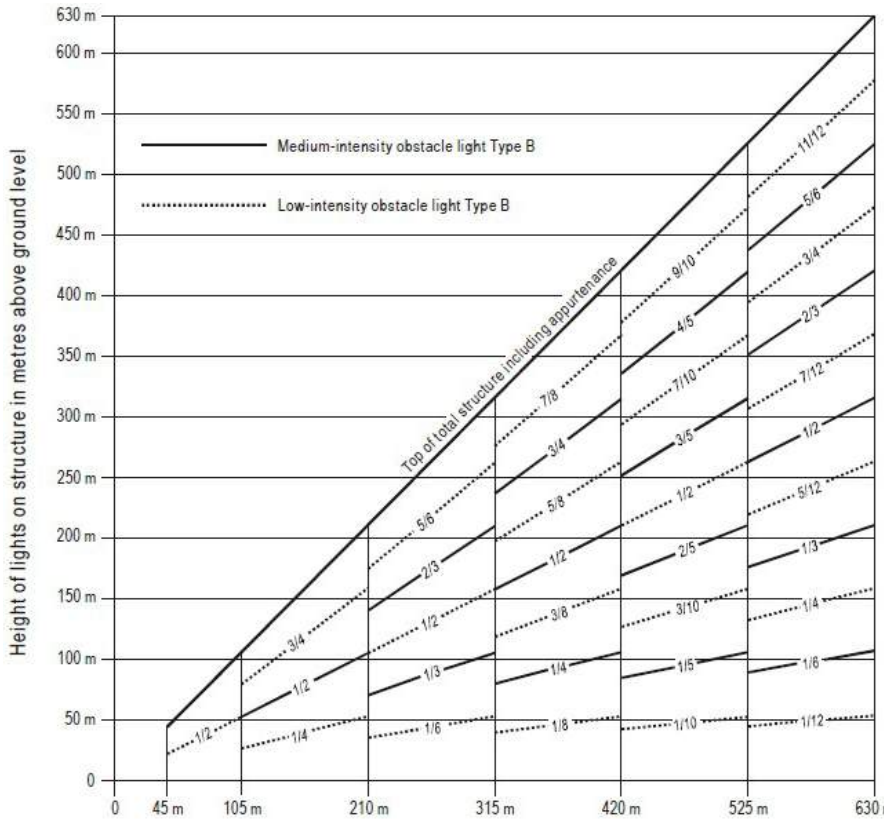
## LOCATION OF LIGHTS ON OBSTACLES

*Figure S7-1. Medium-intensity flashing-white obstacle lighting system, Type A*



Note— High-intensity obstacle lighting is recommended on structures with a height of more than 150 m above ground level. If medium-intensity lighting is used, marking will also be required.

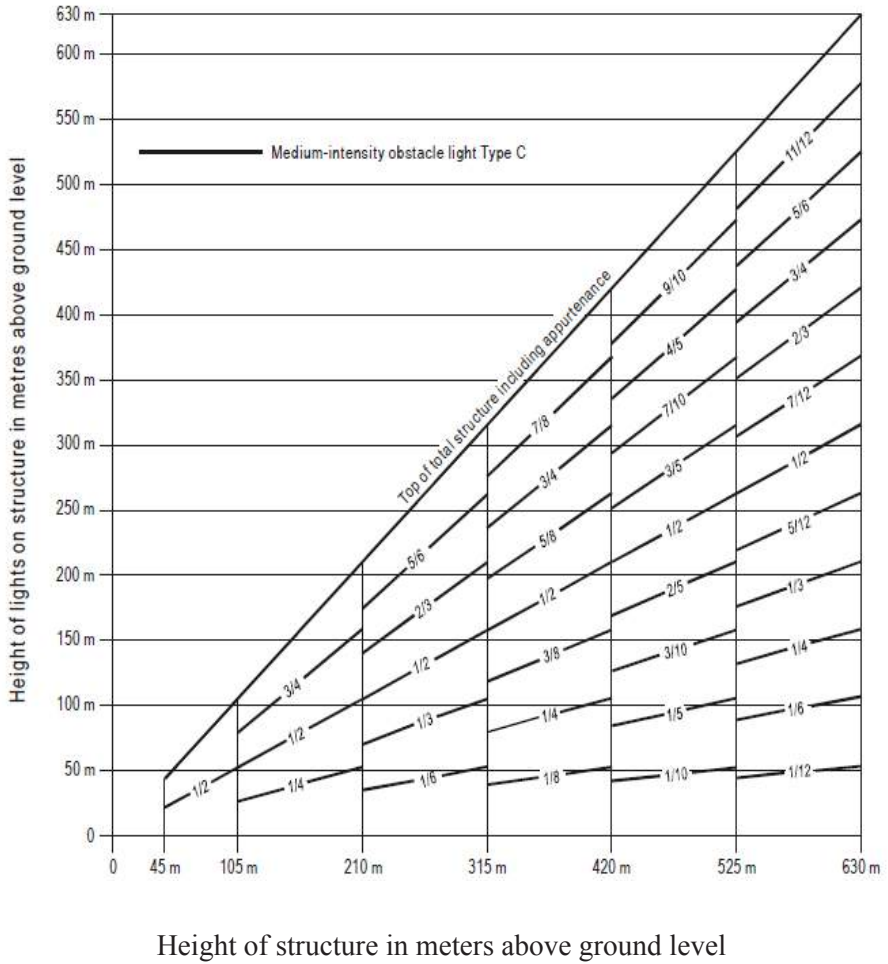
**Figure S7-2. Medium-intensity flashing-red obstacle lighting system, Type B**



Height of structure in meters above ground level

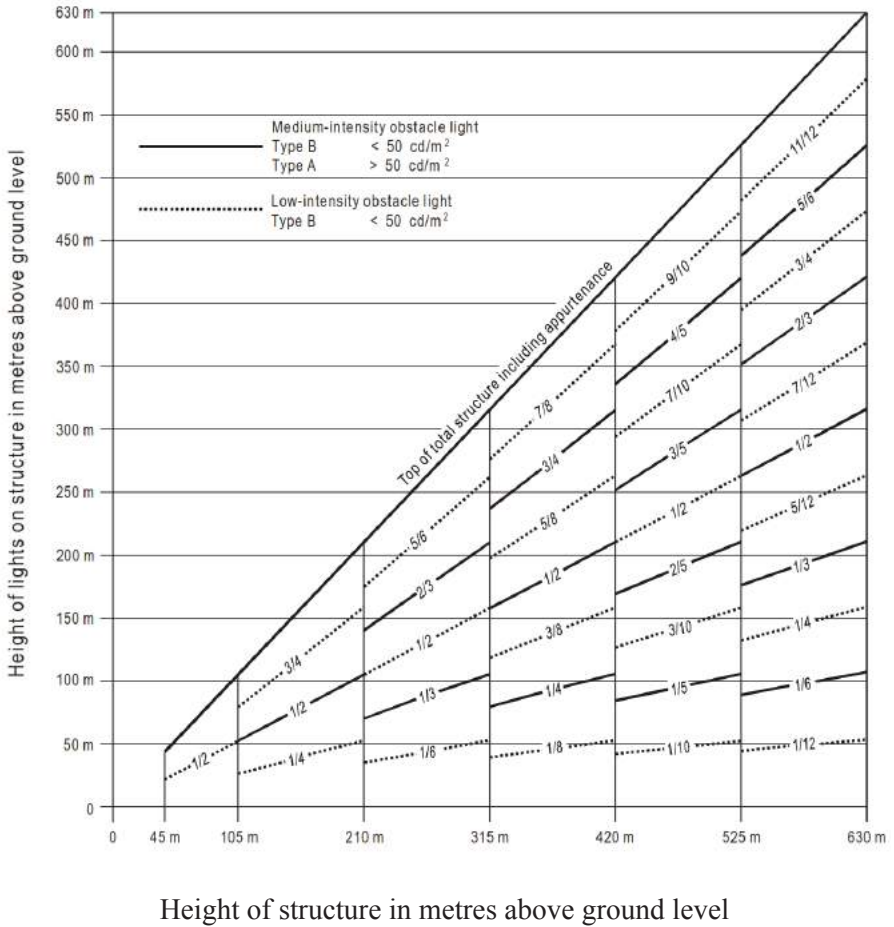
Note.— For night-time use only.

**Figure S7-3. Medium-intensity fixed-red obstacle lighting system, Type C**



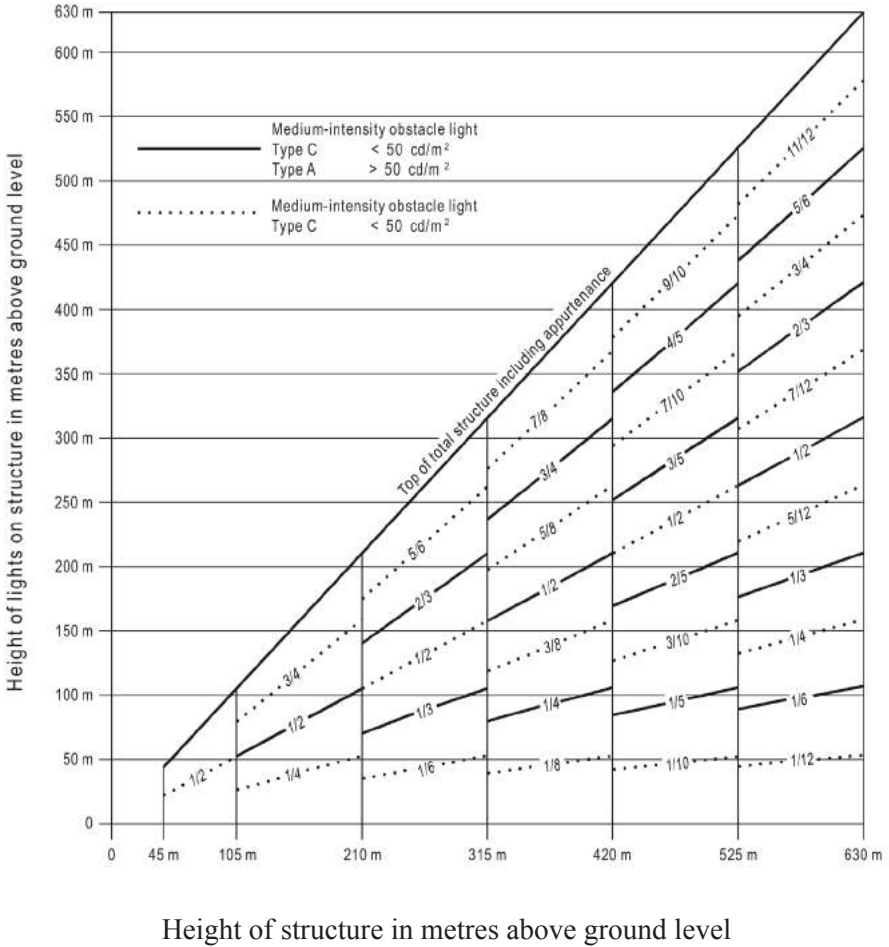
Note.— For night-time use only.

**Figure S7-4. Medium-intensity dual obstacle lighting system, Type A/ Type B**



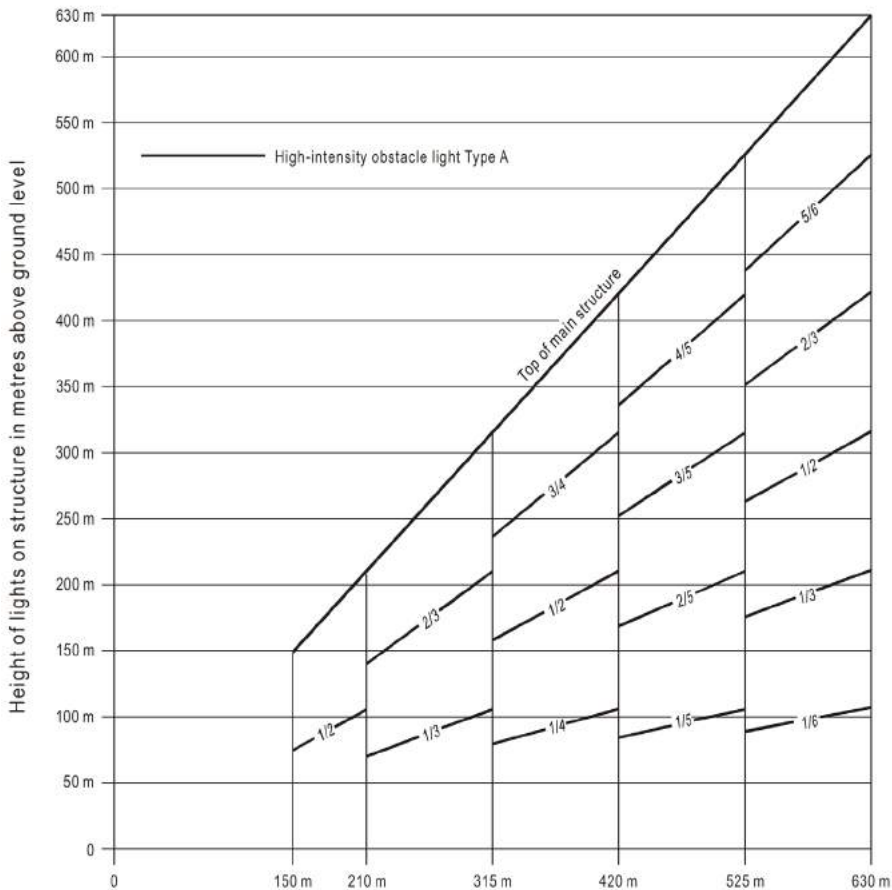
Note— High-intensity obstacle lighting is recommended on structures with a height of more than 150 m above ground level. If medium-intensity lighting is used, marking will also be required.

**Figure S7-5. Medium-intensity dual obstacle lighting system, Type A/ Type C**



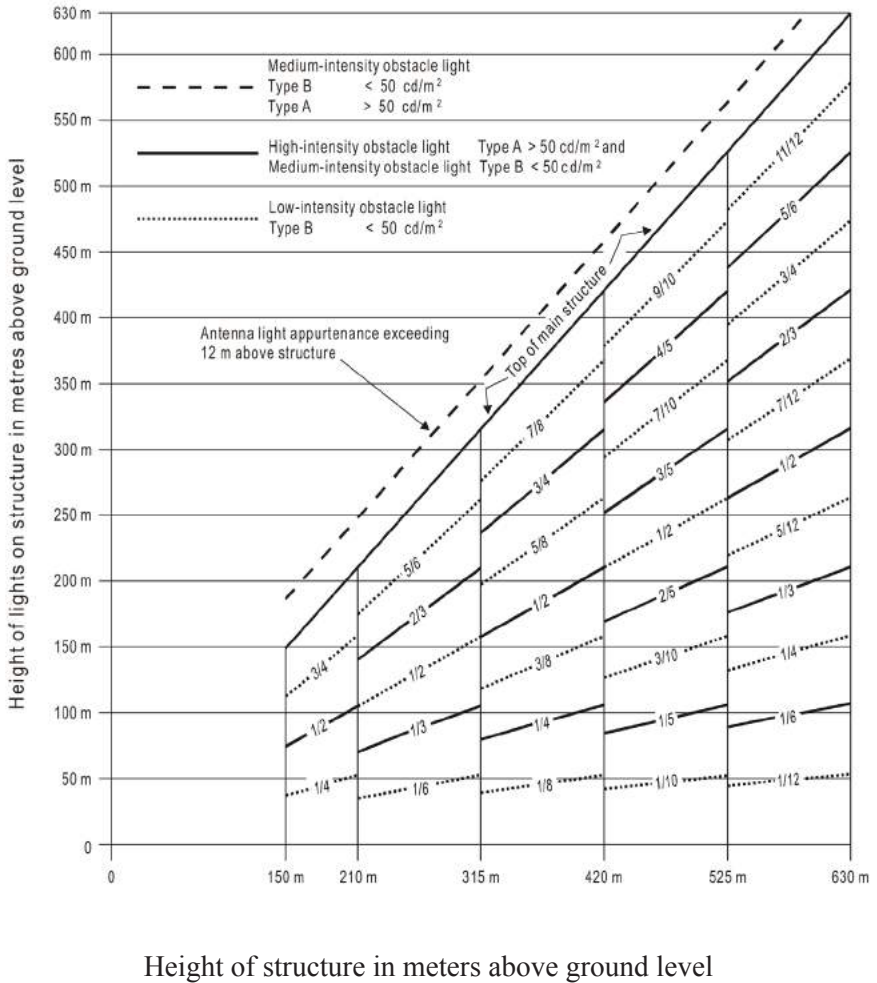
Note — High-intensity obstacle lighting is recommended on structures with a height of more than 150 m above ground level. If medium-intensity lighting is used, marking will also be required.

**Figure S7-6. High-intensity flashing-white obstacle lighting system, Type A**



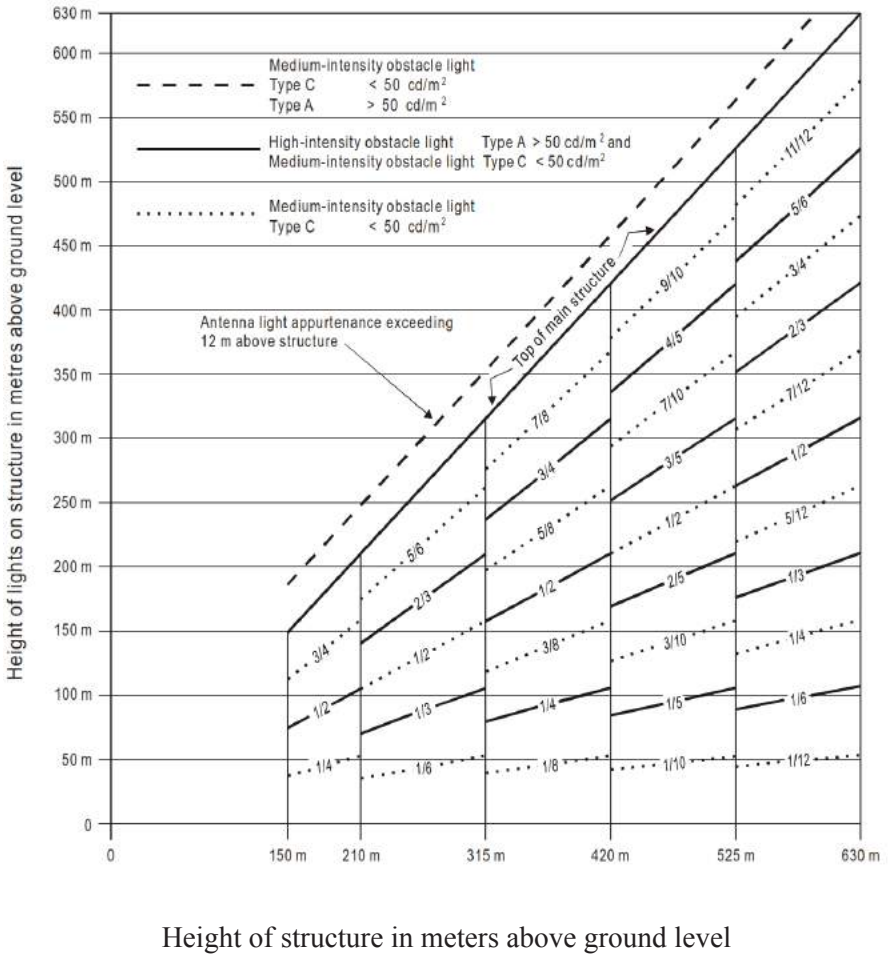
Height of structure in meters above ground level

**Figure S7-7. High-/medium-intensity dual obstacle lighting system, Type A/Type B**





**Figure S7-8. High-/medium-intensity dual obstacle lighting system, Type A/Type C**



## SCHEDULE 8

*Regulations 75, 77, 88, 279*

### GUIDANCE MATERIAL SUPPLEMENTARY TO THESE REGULATIONS

#### 1. **Number, siting and orientation of runways**

- (1) Many factors shall be taken into account in the determination of the siting and orientation of runways. Without attempting to provide an exhaustive list of these factors nor an analysis of their effects, it appears useful to indicate those which most frequently require study. These factors may be classified under four headings:
- (2) *Type of operation.* Attention shall be paid in particular to whether the aerodrome is to be used in all meteorological conditions or only in visual meteorological conditions, and whether it is intended for use by day and night, or only by day.
- (3) *Climatological conditions.* A study of the wind distribution shall be made to determine the usability factor. In this regard, the following comments shall be taken into account—
  - (a) wind statistics used for the calculation of the usability factor are normally available in ranges of speed and direction, and the accuracy of the results obtained depends, to a large extent, on the assumed distribution of observations within these ranges. In the absence of any sure information as to the true distribution, it is usual to assume a uniform distribution since, in relation to the most favourable runway orientations, this generally results in a slightly conservative usability factor.
  - (b) the maximum mean crosswind components given in Regulation 85, refer to normal circumstances. There are some factors which may require that a reduction of those maximum values be taken into account at a particular aerodrome. These include—

- (i) the wide variations which may exist, in handling characteristics and maximum permissible crosswind components, among diverse types of aeroplanes, including future types, within each of the three groups given in regulation 85;
  - (ii) prevalence and nature of gusts;
  - (iii) prevalence and nature of turbulence;
  - (iv) the availability of a secondary runway;
  - (v) the width of runways;
  - (vi) the runway surface conditions — water, on the runway materially reduces the allowable crosswind component; and
  - (vii) the strength of the wind associated with the limiting crosswind component.
- (c) A study shall also be made of the occurrence of poor visibility or low cloud base. Account shall be taken of their frequency as well as the accompanying wind direction and speed.
- (d) *Topography of the aerodrome site, its approaches, and surroundings*, particularly—
- (i) compliance with the obstacle limitation surfaces;
  - (ii) current and future land use. The orientation and layout should be selected so as to protect as far as possible the particularly sensitive areas such as residential, school and hospital zones from the discomfort caused by aircraft noise;
  - (iii) current and future runway lengths to be provided;
  - (iv) construction costs; and
  - (v) possibility of installing suitable non-visual and visual aids for approach-to-land.

- (e) *Air traffic in the vicinity of the aerodrome, particularly—*
  - (i) proximity of other aerodromes or ATS routes;
  - (ii) traffic density; and
  - (iii) air traffic control and missed approach procedures.
- (4) The number of runways to be provided in each direction depends on the number of aircraft movements to be catered for.

## 2. **Clearways and stopways**

- (1) The decision to provide a stopway and/or a clearway as an alternative to an increased length of runway will depend on the physical characteristics of the area beyond the runway end, and on the operating performance requirements of the prospective aeroplanes.
- (2) The runway, stopway and clearway lengths to be provided are determined by the aeroplane take-off performance, but a check shall also be made of the landing distance required by the aeroplanes using the runway to ensure that adequate runway length is provided for landing. The length of a clearway, however, cannot exceed half the length of take-off run available.
- (3) The aeroplane performance operating limitations require a length which is enough to ensure that the aeroplane can, after starting a take-off, either be brought safely to a stop or complete the take-off safely. For the purpose of discussion it is supposed that the runway, stopway and clearway lengths provided at the aerodrome are only just adequate for the aeroplane requiring the longest take-off and accelerate-stop distances, taking into account its take-off mass, runway characteristics and ambient atmospheric conditions.
- (4) Under these circumstances there is, for each take-off, a speed, called the decision speed; below this speed, the take-off must be abandoned if an engine fails, while above it the take-off must be completed. A very long take-off run and take-off distance would be required to complete a take-off when an engine fails before the decision speed is reached, because of the insufficient speed and the reduced power available.

- (5) There would be no difficulty in stopping in the remaining accelerate-stop distance available provided action is taken immediately. In these circumstances the correct course of action would be to abandon the take-off.
- (6) On the other hand, if an engine fails after the decision speed is reached, the aeroplane will have sufficient speed and power available to complete the take-off safely in the remaining take-off distance available. However, because of the high speed, there would be difficulty in stopping the aeroplane in the remaining accelerate-stop distance available.
- (7) The decision speed is not a fixed speed for any aeroplane, but can be selected by the pilot within limits to suit the accelerate-stop and take-off distance available, aeroplane take-off mass, runway characteristics and ambient atmospheric conditions at the aerodrome. Normally, a higher decision speed is selected as the accelerate-stop distance available increases.
- (8) A variety of combinations of accelerate-stop distances required and take-off distances required can be obtained to accommodate a particular aeroplane, taking into account the aeroplane take-off mass, runway characteristics, and ambient atmospheric conditions. Each combination requires its particular length of take-off run.
- (9) The most familiar case is where the decision speed is such that the take-off distance required is equal to the accelerate-stop distance required; this value is known as the balanced field length. Where stopway and clearway are not provided, these distances are both equal to the runway length. However, if landing distance is for the moment ignored, runway is not essential for the whole of the balanced field length, as the take-off run required is, of course, less than the balanced field length.
- (10) The balanced field length can, therefore, be provided by a runway supplemented by an equal length of clearway and stopway, instead of wholly as a runway. If the runway is used for take-off in both directions, an equal length of clearway and stopway has to be provided at each runway end. The saving in runway length is, therefore, bought at the cost of a greater overall length.

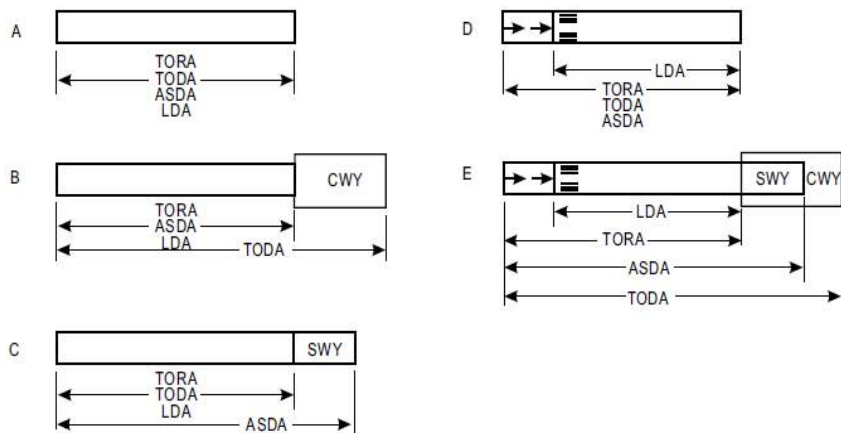
- (11) In case economic considerations preclude the provision of stopway and, as a result, only runway and clearway are to be provided, the runway length (neglecting landing requirements) shall be equal to the accelerate-stop distance required or the take-off run required, whichever is the greater. The take-off distance available will be the length of the runway plus the length of clearway.
- (12) The minimum runway length and the maximum stopway or clearway length to be provided may be determined as follows, from the data in the aeroplane flight manual for the aeroplane considered to be critical from the viewpoint of runway length requirements—
- (a) if a stopway is economically possible, the lengths to be provided are those for the balanced field length. The runway length is the take-off run required or the landing distance required, whichever is the greater. If the accelerate-stop distance required is greater than the runway length so determined, the excess may be provided as stopway, usually at each end of the runway. In addition, a clearway of the same length as the stopway must also be provided;
  - (b) if a stopway is not to be provided, the runway length is the landing distance required, or if it is greater, the accelerate- stop distance required, which corresponds to the lowest practical value of the decision speed. The excess of the take- off distance required over the runway length may be provided as clearway, usually at each end of the runway.
- (13) In addition to the above consideration, the concept of clearways in certain circumstances can be applied to a situation where the take-off distance required for all engines operating exceeds that required for the engine failure case.
- (14) The economy of a stopway can be entirely lost if, after each usage, it must be regraded and compacted. Therefore, it shall be designed to withstand at least a certain number of loadings

of the aeroplane which the stopway is intended to serve without inducing structural damage to the aeroplane.

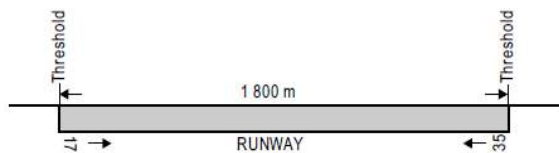
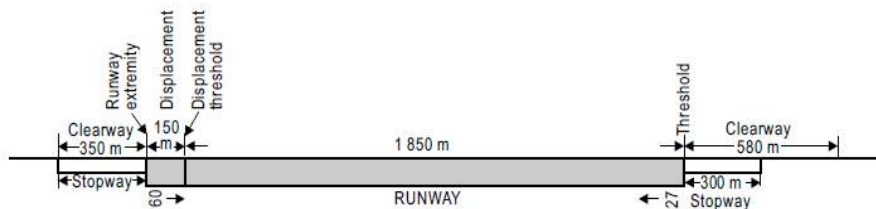
### 3. **Calculation of declared distances**

- (1) The declared distances to be calculated for each runway direction comprise: the take-off run available (TORA), take-off distance available (TODA), accelerate-stop distance available (ASDA), and landing distance available (LDA).
- (2) Where a runway is not provided with a stopway or clearway and the threshold is located at the extremity of the runway, the four declared distances shall normally be equal to the length of the runway, as shown in Figure S8-1 (A).
- (3) Where a runway is provided with a clearway (CWY), then the TODA will include the length of clearway, as shown in Figure S8-1 (B).
- (4) Where a runway is provided with a stopway (SWY), then the ASDA will include the length of stopway, as shown in Figure S8-1 (C).
- (5) Where a runway has a displaced threshold, then the LDA will be reduced by the distance the threshold is displaced, as shown in Figure S8-1 (D). A displaced threshold affects only the LDA for approaches made to that threshold; all declared distances for operations in the reciprocal direction are unaffected.
- (6) Figures S8-1 (B) through S8-1 (D) illustrate a runway provided with a clearway or a stopway or having a displaced threshold. Where more than one of these features exist, then more than one of the declared distances will be modified — but the modification will follow the same principle illustrated. An example showing a situation where all these features exist is shown in Figure S8-1 (E).
- (7) A suggested format for providing information on declared distances is given in Figure S8-1 (F). If a runway direction cannot be used for take-off or landing, or both, because it is operationally forbidden, then this shall be declared and the words “not usable” or the abbreviation “NU” entered.

Figure S8-1. Illustration of declared distances



Note.— All declared distances are illustrated for operations from left to right.



F

RUNWAY	TORA	ASDA	TODA	LDA
	m	m	m	m
09	2 000	2 300	2 580	1 850
27	2 000	2 350	2 350	2 000
17	NU	NU	NU	1 800
35	1 800	1 800	1 800	NU



4. **Slopes on a runway**

- (1) Distance between slope changes

The following example illustrates how the distance between slope changes is to be determined (see Figure S8-2): D for a runway where the code number is 3 shall be at least:

$$15\,000 (|x - y| + |y - z|) \text{ m}$$

$|x - y|$  being the absolute numerical value of  $x - y$

$|y - z|$  being the absolute numerical value of  $y - z$

Assuming  $x = +0.01$

$$y = -0.005$$

$$z = +0.005$$

then  $|x - y| = 0.015$

$$|y - z| = 0.01$$

To comply with the specifications, D shall be not less than:

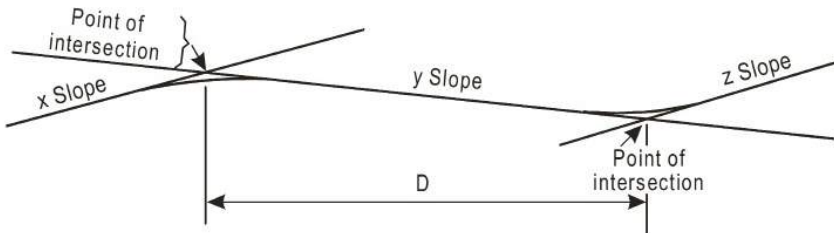
$$15\,000 (0.015 + 0.01) \text{ m,}$$

that is,  $15\,000 \times 0.025 = 375 \text{ m}$

- (2) Consideration of longitudinal and transverse slopes

When a runway is planned that will combine the extreme values for the slopes and changes in slope permitted under regulation 91, a study shall be made to ensure that the resulting surface profile will not hamper the operation of aeroplanes.

**Figure S8-2. Profile on centre line of runway**



- (3) Radio altimeter operating area

(a) In order to accommodate aeroplanes making auto-coupled approaches and automatic landings (irrespective of weather conditions) it is desirable that slope changes

be avoided or kept to a minimum, on a rectangular area at least 300 m long before the threshold of a precision approach runway. The area shall be symmetrical about the extended centre line, 120 m wide.

- (b) When special circumstances so warrant, the width may be reduced to no less than 60 m if an aeronautical study indicates that such reduction would not affect the safety of operations of aircraft. This is desirable because these aeroplanes are equipped with a radio altimeter for final height and flare guidance, and when the aeroplane is above the terrain immediately prior to the threshold, the radio altimeter will begin to provide information to the automatic pilot for auto-flare. Where slope changes cannot be avoided, the rate of change between two consecutive slopes shall not exceed 2 per cent per 30 m.

5. **Runway surface evenness**

- (1) In adopting tolerances for runway surface irregularities, the following standard of construction is achievable for short distances of 3 m and conforms to good engineering practice except across the crown of a camber or across drainage channels, the finished surface of the wearing course is to be of such regularity that, when tested with a 3 m straight-edge placed anywhere in any direction on the surface, there is no deviation greater than 3 mm between the bottom of the straight-edge and the surface of the pavement anywhere along the straight-edge.
- (2) Caution shall also be exercised when inserting runway lights or drainage grilles in runway surfaces to ensure that adequate smoothness of the surface is maintained.
- (3) The operation of aircraft and differential settlement of surface foundations will eventually lead to increases in surface irregularities. Small deviations in the above tolerances will not seriously hamper aircraft operations. In general, isolated irregularities of the order of 2.5 cm to 3 cm over a 45 m

distance are acceptable, as shown in Figure S8-3. Although maximum acceptable deviations vary with the type and speed of an aircraft, the limits of acceptable surface irregularities can be estimated to a reasonable extent.

- (4) The following table describes acceptable, tolerable and excessive limits—

Surface irregularity	Length of irregularity (m)								
	3	6	9	12	15	20	30	45	60
Acceptable surface irregularity height (cm)	2.9	3.8	4.5	5	5.4	5.9	6.5	8.5	10
Tolerable surface irregularity height (cm)	3.9	5.5	6.8	7.8	8.6	9.6	11	13.6	16
Excessive surface irregularity height (cm)	5.8	7.6	9.1	10	10.8	11.9	13.9	17	20

- (a) if the surface irregularities exceed the heights defined by the acceptable limit curve but are less than the heights defined by the tolerable limit curve, at the specified minimum acceptable length, herein noted by the tolerable region, then maintenance action shall be planned. The runway may remain in service. This region is the start of possible passenger and pilot discomfort;
- (b) if the surface irregularities exceed the heights defined by the tolerable limit curve, but are less than the heights defined by the excessive limit curve, at the specified minimum acceptable length, herein noted by the excessive region, then maintenance corrective action is mandatory to restore the condition to the acceptable region. The runway may remain in service but be repaired within a reasonable period. This region could lead to the risk of possible aircraft structural damage due to a single event

- or fatigue failure over time; and
- (c) if the surface irregularities exceed the heights defined by the excessive limit curve, at the specified minimum acceptable length, herein noted by the unacceptable region, then the area of the runway where the roughness has been identified warrants closure. Repairs must be made to restore the condition to within the acceptable limit region and the aircraft operators may be advised accordingly. This region runs the extreme risk of a structural failure and must be addressed immediately.

Note that “surface irregularity” is defined under this paragraph to mean isolated surface elevation deviations that do not lie along a uniform slope through any given section of a runway. For the purposes of this concern, a “section of a runway” is defined herein to mean a segment of a runway throughout which a continuing general uphill, downhill or flat slope is prevalent. The length of this section is generally between 30 and 60 meters, and can be greater, depending on the longitudinal profile and the condition of the pavement.

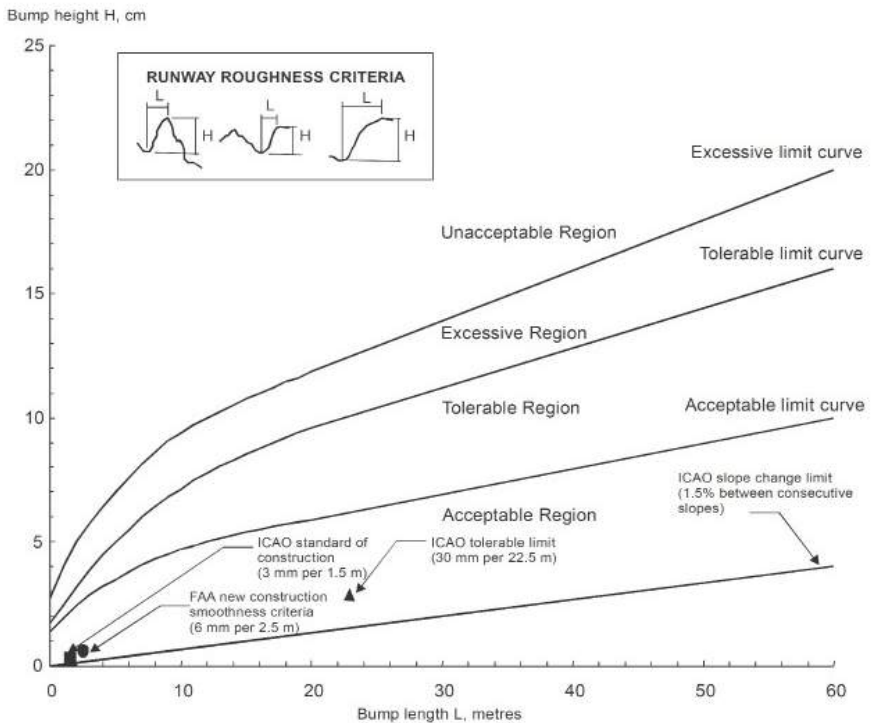
The maximum tolerable step type bump, such as that which could exist between adjacent slabs, is simply the bump height corresponding to zero bump length at the upper end of the tolerable region of the roughness criteria of Figure S8-3. The bump height at this location is 1.75 cm.

- (5) Figure S8-3 illustrates a comparison of the surface roughness criteria with those developed by the United States Federal Aviation Administration.
- (6) These criteria address single event roughness, not long wavelength harmonic effects nor the effect of repetitive surface undulations.
- (7) Deformation of the runway with time may also increase the possibility of the formation of water pools. Pools as shallow as approximately 3 mm in depth, particularly if they are located where they are likely to be encountered at high speed

by landing aeroplanes, can induce aquaplaning, which can then be sustained on a wet runway by a much shallower depth of water.

- (8) Improved guidance regarding the significant length and depth of pools relative to aquaplaning is the subject of further research. It is, of course, especially necessary to prevent pools from forming.

**Figure S8 -3. Comparison of roughness criteria**



## 6. Runway condition report for reporting runway surface condition

- (1) Movement areas are exposed to a multitude of climatic conditions and consequently a significant difference in the condition to be reported. The runway condition report (RCR) describes a basic methodology applicable for all these climatic variations.

- (2) The concept of the RCR is premised on:
- (a) an agreed set of criteria used in a consistent manner for runway surface condition assessment, aeroplane (performance) certification and operational performance calculation;
  - (b) a unique runway condition code (RWYCC) linking the agreed set of criteria with the aircraft landing and takeoff performance table, and related to the braking action experienced and eventually reported by flight crews;
  - (c) reporting of contaminant type and depth that is relevant to take-off performance;
  - (d) a standardized common terminology and phraseology for the description of runway surface conditions that can be used by aerodrome operator inspection personnel, air traffic controllers, aircraft operators and flight crew; and
- (e) harmonized procedures for the establishment of the RWYCC with a built-in flexibility to allow for local variations to match the specific weather, infrastructure and other particular conditions.
- (3) These harmonized procedures are reflected in a runway condition assessment matrix (RCAM) which correlates the RWYCC, the agreed set of criteria and the aircraft braking action which the flight crew shall expect for each value of the RWYCC.
- (4) Procedures which relate to the use of the RCAM are provided in the technical guidance material provided by the authority.
- (5) It is recognized that information provided by the aerodrome's personnel assessing and reporting runway surface condition is crucial to the effectiveness of the runway condition report. A misreported runway condition alone should not lead to an accident or incident. Operational margins should cover for a reasonable error in the assessment, including unreported changes in the runway condition. But a misreported runway condition can mean that the margins are no longer available to cover for other operational variance (such as unexpected tailwind, high and fast approach above threshold or long flare).

- (6) This is further amplified by the need for providing the assessed information in the proper format for dissemination, which requires insight into the limitations set by the syntax for dissemination. This in turn restricts the wording of plain text remarks that can be provided.
- (7) It is important to follow standard procedures when providing assessed information on the runway surface conditions to ensure that safety is not compromised when aeroplanes use wet or contaminated runways.
- (8) Personnel shall be trained in the relevant fields of competence and their competence verified in a manner required by the authority to ensure confidence in their assessments.
- (9) The training syllabus may include initial and periodic recurrent training in the following areas:
  - (a) aerodrome familiarization, including aerodrome markings, signs and lighting;
  - (b) aerodrome procedures as described in the aerodrome manual;
  - (c) aerodrome emergency plan;
  - (d) Notice to Airmen (NOTAM) initiation procedures;
  - (e) completion of initiation procedures for RCR;
  - (f) aerodrome driving rules;
  - (g) air traffic control procedures on the movement area;
  - (h) radiotelephone operating procedures;
  - (i) phraseology used in aerodrome control, including the ICAO spelling alphabet;
  - (j) aerodrome inspection procedures and techniques;
  - (k) type of runway contaminants and reporting;
  - (l) assessment and reporting of runway surface friction characteristics;
  - (m) use of runway friction measurement device;

- (n) calibration and maintenance of runway friction measurement device;
- (o) awareness of uncertainties related to (l) and (m); and
- (p) low visibility procedures.

7. **Drainage characteristics of the movement area and adjacent areas**

- (1) Rapid drainage of surface water is a primary safety consideration in the design, construction and maintenance of the movement area and adjacent areas. The objective is to minimize water depth on the surface by draining water off the runway in the shortest path possible and particularly out of the area of the wheel path. There are two distinct drainage processes taking place—
  - (a) natural drainage of the surface water from the top of the pavement surface until it reaches the final recipient such as rivers or other water bodies; and
  - (b) dynamic drainage of the surface water trapped under a moving tire until it reaches outside the tire-to-ground contact area.
- (2) Both processes can be controlled through —
  - (a) design;
  - (b) construction; and
  - (c) maintenance;

of the pavements in order to prevent accumulation of water on the pavement surface.

- (3) Surface drainage is a basic requirement and serves to minimize water depth on the surface. The objective is to drain water off the runway in the shortest path. Adequate surface drainage is provided primarily by an appropriately sloped surface (in both the longitudinal and transverse directions). The resulting combined longitudinal and transverse slope is the path for the drainage run-off. This path can be shortened by adding transverse grooves.



- (4) Dynamic drainage is achieved through built-in texture in the pavement surface. The rolling tire builds up water pressure and squeezes the water out the escape channels provided by the texture. The dynamic drainage of the tire-to-ground contact area may be improved by adding transverse grooves provided that they are subject to rigorous maintenance.
- (5) Through construction, the drainage characteristics of the surface are built into the pavement and the surface characteristics are—
  - (a) slopes;
  - (b) texture:
    - (i) microtexture;
    - (ii) macrotexture;
- (6) Slopes for the various parts of the movement area and adjacent parts are described in Part VIII Aerodromes Physical characteristics and figures are given as per cent.
- (7) Texture in the literature is described as microtexture or macrotexture. These terms are understood differently in various parts of the aviation industry.
- (8) Microtexture is the texture of the individual stones and is hardly detectable by the eye. Microtexture is considered a primary component in skid resistance at slow speeds. On a wet surface at higher speeds a water film may prevent direct contact between the surface asperities and the tire due to insufficient drainage from the tire-to-ground contact area.
- (9) Microtexture is a built-in quality of the pavement surface. By specifying crushed material that will withstand polishing microtexture, drainage of thin waterfilms are ensured for a longer period of time. Resistance against polishing is expressed in terms of the Polished Stone Values (PSV) which is in principle a value obtained from a friction measurement in accordance with the international standards. These standards define the PSV minima that will enable a material with a good microtexture to be selected.

- (10) A major problem with microtexture is that it can change within short time periods without being easily detected. A typical example of this is the accumulation of rubber deposits in the touchdown area which will largely mask microtexture without necessarily reducing macrotexture.
- (11) Macrotexture is the texture among the individual stones. This scale of texture may be judged approximately by the eye. Macrotexture is primarily created by the size of aggregate used or by surface treatment of the pavement and is the major factor influencing drainage capacity at high speeds. Materials shall be selected so as to achieve good macrotexture.
- (12) The primary purpose of grooving a runway surface is to enhance surface drainage. Natural drainage can be slowed down by surface texture, but grooving can speed up the drainage by providing a shorter drainage path and increasing the drainage rate.
- (13) For measurement of macrotexture, simple methods such as the “sand and grease patch” method were developed. These methods were used for the early research on which current airworthiness requirements are based, which refer to a classification categorising macrotexture from A to E. This classification was developed, using sand or grease patch measuring techniques, and issued in 1971 by the Engineering Sciences Data Unit (ESDU).

Runway classification based on texture information from ESDU 71026:

Classification	Texture depths (mm)
A	0.10 – 0.14
B	0.15 – 0.24
C	0.25 – 0.50
D	0.51 – 1.00
E	– 2.54

- (14) Using this classification, the threshold value between micro texture and macrottexture is 0.1 mm mean texture depth (MTD). Related to this scale, the normal wet runway aircraft performance is based upon texture giving drainage and friction qualities midway between classification B and C (0.25 mm). Improved drainage through better texture might qualify for a better aircraft performance class. However such credit must be in accordance with the aeroplane manufacturers' documentation and agreed by the Authority. Presently credit is given to grooved or porous friction course runways following design, construction and maintenance criteria acceptable to the authority.
- (15) ISO 13473-1: Characterisation of pavement texture by use of surface profiles — Part 1: Determination of Mean Profile Depth links the volumetric measuring technique with non-contact profile measuring techniques giving comparable texture values. These standards describe the threshold value between microtexture and macrottexture as 0.5 mm. The volumetric method has a validity range from 0.25 to 5 mm MTD. The profilometry method has a validity range from 0 to 5 mm mean profile depth (MPD). The values of MPD and MTD differ due to the finite size of the glass spheres used in the volumetric technique and because the MPD is derived from a two-dimensional profile rather than a three-dimensional surface. Therefore a transformation equation must be established for the measuring equipment used to relate MPD to MTD.
- (16) The ESDU scale groups runway surfaces based on macrottexture from A through E, where E represents the surface with best dynamic drainage capacity. The ESDU scale thus reflects the dynamic drainage characteristics of the pavement. Grooving any of these surfaces enhances the dynamic drainage capacity. The resulting drainage capacity of the surface is thus a function of the texture (Although E) and grooving. The contribution from grooving is a function of the size of the grooves and the spacing between the grooves.

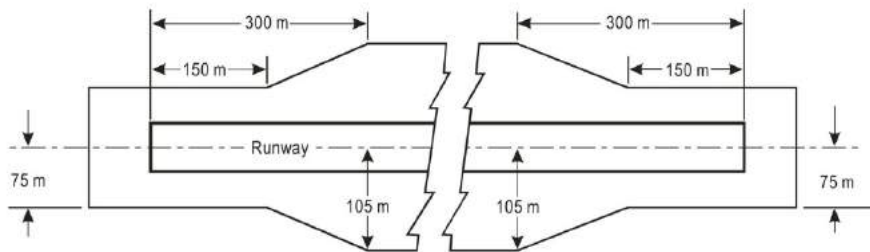
- (17) Aerodromes exposed to heavy or torrential rainfall must ensure that the pavement and adjacent areas have drainage capability to withstand these rainfalls or put limitations on the use of the pavements under such extreme situations. These airports shall seek to have the maximum allowable slopes and the use of aggregates providing good drainage characteristics. They shall also consider grooved pavements in the E classification to ensure that safety is not impaired.
- (18) Macrottexture does not change within a short timespan but accumulation of rubber can fill up the texture and as such reduce the drainage capacity, which can result in impaired safety. Furthermore the runway structure may change over time and give unevenness which results in ponding after rainfall.
- (19) When groovings are used, the condition of the grooves shall be regularly inspected to ensure that no deterioration has occurred and that the grooves are in good condition.
- (20) The pavement may be shot blasted in order to enhance the pavement macrottexture.

## 8. **Strips**

- (1) The shoulder of a runway or stopway shall be prepared or constructed so as to minimize any hazard to an aeroplane running off the runway or stopway. Some guidance is given in the following paragraphs on certain special problems which may arise, and on the further question of measures to avoid the ingestion of loose stones or other objects by turbine engines.
- (2) In some cases, the bearing strength of the natural ground in the strip may be sufficient, without special preparation, to meet the requirements for shoulders. Where special preparation is necessary, the method used will depend on local soil conditions and the mass of the aeroplanes the runway is intended to serve. Soil tests will help in determining the best method of improvement such as drainage, stabilisation, surfacing, and light paving.

- (3) Attention shall also be paid when designing shoulders to prevent the ingestion of stones or other objects by turbine engines.
- (4) Where shoulders have been treated specially, either to provide the required bearing strength or to prevent the presence of stones or debris, difficulties may arise because of a lack of visual contrast between the runway surface and that of the adjacent strip. This difficulty can be overcome either by providing a good visual contrast in the surfacing of the runway or strip, or by providing a runway side stripe marking.
- (5) Within the general area of the strip adjacent to the runway, measures shall be taken to prevent an aeroplane's wheel, when sinking into the ground, from striking a hard vertical face. Special problems may arise for runway light fittings or other objects mounted in the strip or at the intersection with a taxiway or another runway. In the case of construction, such as runways or taxiways, where the surface must also be flush with the strip surface, a vertical face can be eliminated by chamfering from the top of the construction to not less than 30 cm below the strip surface level. Other objects, the functions of which do not require them to be at surface level, shall be buried to a depth of not less than 30 cm.
- (6) Regulation 96 (8), requires that the portion of a strip of an instrument runway within at least 75 m from the centre line shall be graded where the code number is 3 or 4. For a precision approach runway, it may be desirable to adopt a greater width where the code number is 3 or 4. Figure S8-4 shows the shape and dimensions of a wider strip that may be considered for such a runway. This strip has been designed using information on aircraft running off runways. The portion to be graded extends to a distance of 105 m from the centre line, except that the distance is gradually reduced to 75 m from the centre line at both ends of the strip, for a length of 150 m from the runway end.

**Figure S8-4. Graded portion of a strip including a precision approach runway where the code number is 3 or 4**



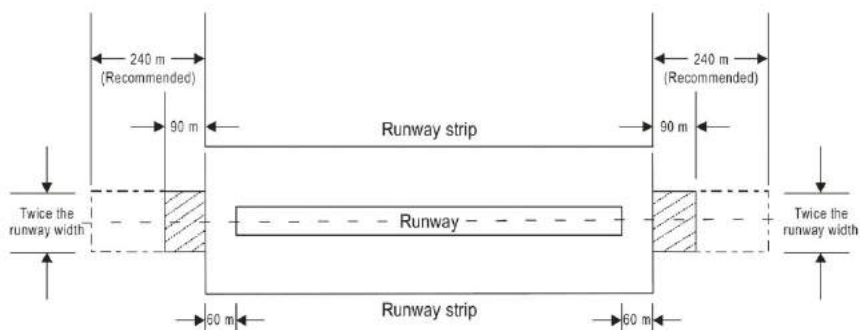
## 9. Runway end safety areas

- (1) Where a runway end safety area is provided in accordance with part VIII, consideration shall be given to providing an area long enough to contain overruns and undershoots resulting from a reasonably probable combination of adverse operational factors. On a precision approach runway, the ILS localizer is normally the first upstanding obstacle, and the runway end safety area shall extend up to this facility. In other circumstances, the first upstanding obstacle may be a road, a railroad or other constructed or natural feature. The provision of a runway end safety area shall take such obstacles into consideration.
- (2) Where provision of a runway end safety area would be particularly prohibitive to implement, consideration would have to be given to reducing some of the declared distances of the runway for the provision of a runway end safety area and installation of an arresting system.
- (3) Research programmes, as well as evaluation of actual aircraft overruns into arresting systems, have demonstrated that the performance of some arresting systems can be predictable and effective in arresting aircraft overruns.
- (4) Demonstrated performance of an arresting system can be achieved by a validated design method, which can predict the performance of the system. The design and performance

shall be based on the type of aircraft anticipated to use the associated runway that imposes the greatest demand upon the arresting system.

- (5) The design of an arresting system must consider multiple aircraft parameters, including but not limited to, allowable aircraft gear loads, gear configuration, tire contact pressure, aircraft centre of gravity and aircraft speed. Accommodating undershoots must also be addressed. Additionally, the design must allow the safe operation of fully loaded rescue and fire-fighting vehicles, including their ingress and egress.
- (6) The information relating to the provision of a runway end safety area and the presence of an arresting system shall be published in the AIP.

**Figure S8-5. Runway end safety area for a runway where the code number is 3 or 4**



## 10. Location of threshold

- (1) The threshold is normally located at the extremity of a runway, if there are no obstacles penetrating above the approach surface. In some cases, however, due to local conditions it may be desirable to displace the threshold permanently.
- (2) When studying the location of a threshold, consideration shall also be given to the height of the ILS reference datum and the determination of the obstacle clearance limits. Specifications concerning the height of the ILS reference datum are given

in Civil Aviation (Aeronautical Radio Navigation Aids) Regulations, 2022

- (3) In determining that no obstacles penetrate above the approach surface, account shall be taken of mobile objects such as vehicles on roads, trains and others at least within that portion of the approach area within 1 200 m longitudinally from the threshold and of an overall width of not less than 150 m.
- (4) If an object extends above the approach surface and the object cannot be removed, consideration shall be given to displacing the threshold permanently.
- (5) To meet the obstacle limitation objectives of Part IX, the threshold shall ideally be displaced down the runway for the distance necessary to provide that the approach surface is cleared of obstacles.
- (6) However, displacement of the threshold from the runway extremity will inevitably cause reduction of the landing distance available, and this may be of greater operational significance than penetration of the approach surface by marked and lighted obstacles. A decision to displace the threshold, and the extent of such displacement, shall therefore have regard to an optimum balance between the considerations of clear approach surfaces and adequate landing distance. In deciding this question, account will need to be taken of the types of aeroplanes which the runway is intended to serve, the limiting visibility and cloud base conditions under which the runway will be used, the position of the obstacles in relation to the threshold and extended centre line and, in the case of a precision approach runway, the significance of the obstacles to the determination of the obstacle clearance limit.
- (7) Notwithstanding the consideration of landing distance available, the selected position for the threshold shall not be such that the obstacle free surface to the threshold is steeper than 3.3 per cent where the code number is 4 or steeper than 5 per cent where the code number is 3.

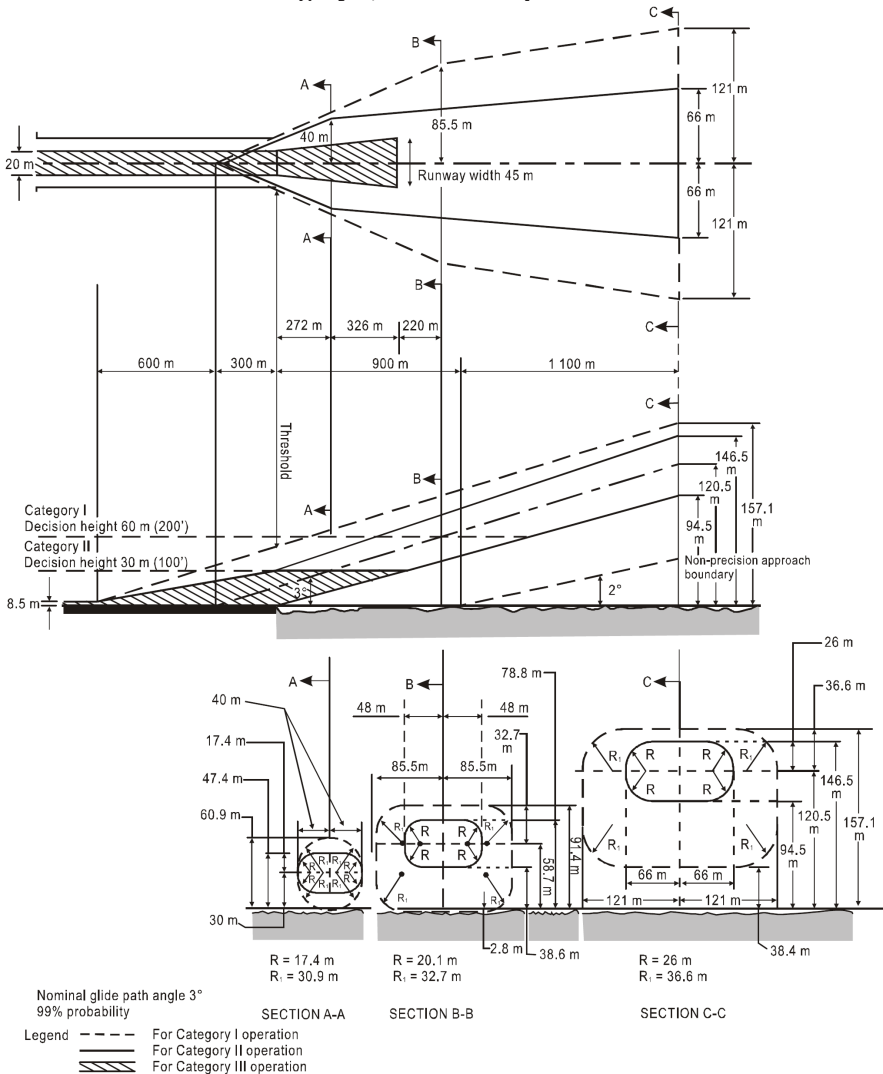


- (8) In the event of a threshold being located according to the criteria for obstacle free surfaces in the preceding paragraph, the obstacle marking requirements of part XI shall continue to be met in relation to the displaced threshold.
- (9) Depending on the length of the displacement, the RVR at the threshold could differ from that at the beginning of the runway for take-offs. The use of red runway edge lights with photometric intensities lower than the nominal value of 10 000 cd for white lights increases that phenomenon. The impact of a displaced threshold on take-off minima shall be assessed by the aerodrome operator and submitted to the authority for consideration.

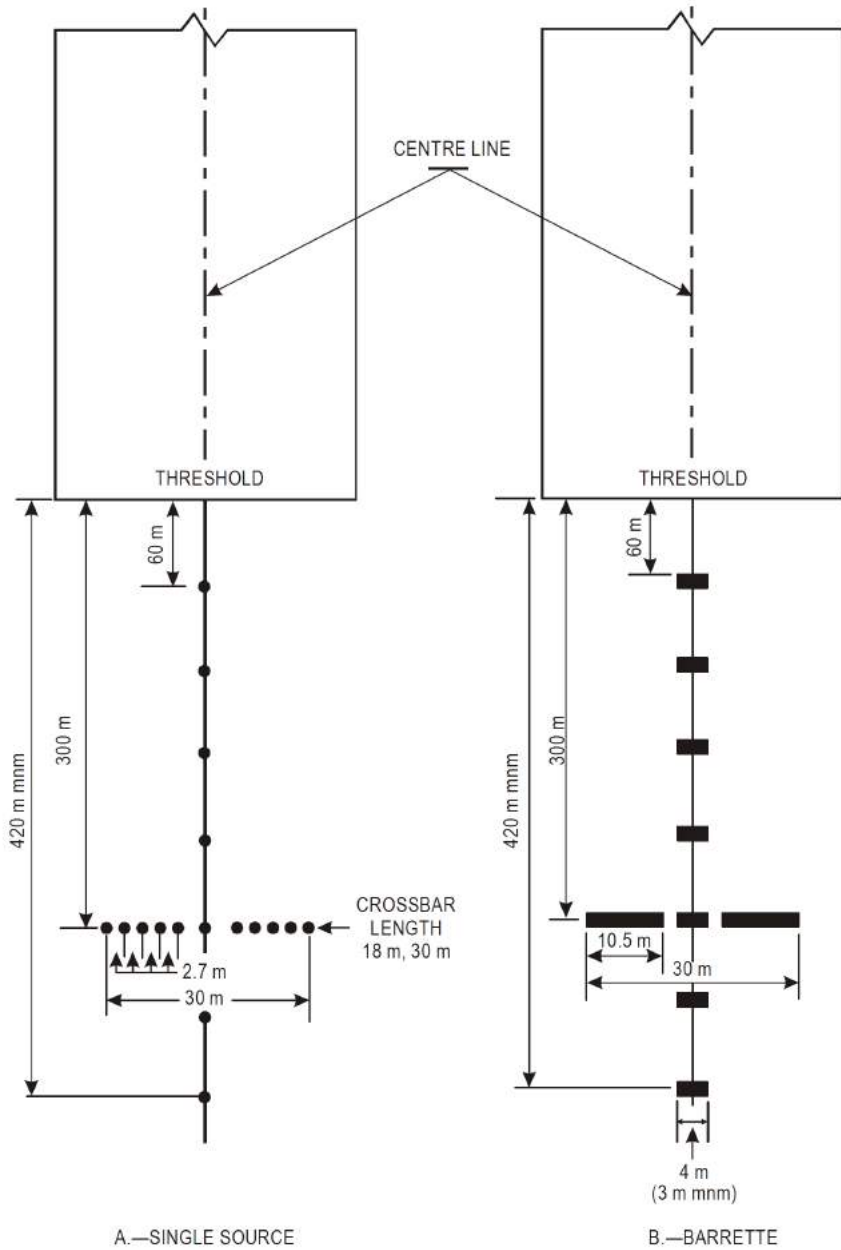
## 11. **Approach lighting systems**

- (1) The specifications in this volume provide for the basic characteristics for simple and precision approach lighting systems. For certain aspects of these systems, some latitude is permitted, for example, in the spacing between centre line lights and crossbars. The approach lighting patterns that have been generally adopted are shown in Figures S8-7 and S8-8. A diagram of the inner 300 m of the precision approach category II and III lighting system is shown in Figure 19.
- (2) The approach lighting configuration is to be provided irrespective of the location of the threshold, i.e. whether the threshold is at the extremity of the runway or displaced from the runway extremity. In both cases, the approach lighting system shall extend up to the threshold. However, in the case of a displaced threshold, inset lights are used from the runway extremity up to the threshold to obtain the specified configuration. These inset lights are designed to satisfy the structural requirements specified in Regulation 159 (1), and the photometric requirements specified in Schedule 4 Figure S4-1 or S4-2.
- (3) Flight path envelopes to be used in designing the lighting are shown in Figure S8-6.

**Figure S8-6. Flight path envelopes to be used for lighting design for category I, II and III operations**



*Figure S8-7. Simple approach lighting systems*



- (4) The dimensional tolerances are shown in Figure S8-8.
- (5) The centre line of an approach lighting system shall be as coincident as possible with the extended centre line of the runway with a maximum tolerance of  $\pm 15'$ .
- (6) The longitudinal spacing of the centre line lights shall be such that one light (or group of lights) is located in the centre of each crossbar, and the intervening centre line lights are spaced as evenly as practicable between two crossbars or a crossbar and a threshold.
- (7) The crossbars and barrettes shall be at right angles to the centre line of the approach lighting system with a tolerance of  $\pm 30'$ , if the pattern in Figure S8-8 (A) is adopted or  $\pm 2^\circ$ , if Figure S8-8 (B) is adopted.
- (8) When a crossbar has to be displaced from its standard position, any adjacent crossbar shall, where possible, be displaced by appropriate amounts in order to reduce the differences in the crossbar spacing.
- (9) When a crossbar in the system shown in Figure S8-8 (A) is displaced from its standard position, its overall length shall be adjusted so that it remains one-twentieth of the actual distance of the crossbar from the point of origin. It is not necessary, however, to adjust the standard 2.7 m spacing between the crossbar lights, but the crossbars shall be kept symmetrical about the centre line of the approach lighting.
- (10) The ideal arrangement is to mount all the approach lights in the horizontal plane passing through the threshold (see Figure S8-9), and this shall be the general aim as far as local conditions permit. However, buildings, trees, etc., shall not obscure the lights from the view of a pilot who is assumed to be  $1^\circ$  below the electronic glide path in the vicinity of the outer marker.
- (11) Within a stopway or clearway, and within 150 m of the end of a runway, the lights shall be mounted as near to the ground as local conditions permit in order to minimize risk of damage to aeroplanes in the event of an overrun or undershoot. Beyond the stopway and clearway, it is not so necessary for the lights to be

mounted close to the ground, and therefore undulations in the ground contours can be compensated for by mounting the lights on poles of appropriate height.

- (12) It is desirable that the lights be mounted so that, as far as possible, no object within a distance of 60 m on each side of the centre line protrudes through the plane of the approach lighting system. Where a tall object exists within 60 m of the centre line and within 1 350 m from the threshold for a precision approach lighting system, or 900 m for a simple approach lighting system, it may be advisable to install the lights so that the plane of the outer half of the pattern clears the top of the object.
- (13) In order to avoid giving a misleading impression of the plane of the ground, the lights shall not be mounted below a gradient of 1 in 66 downwards from the threshold to a point 300 m out, and below a gradient of 1 in 40 beyond the 300 m point. For a precision approach category II and III lighting system, more stringent criteria may be necessary, e.g. negative slopes not permitted within 450 m of the threshold.
- (14) Centre line. The gradients of the centre line in any section, including a stopway or clearway, shall be as small as practicable, and the changes in gradients shall be as few and small as can be arranged and shall not exceed 1 in 60. Experience has shown that as one proceeds outwards from the runway, rising gradients in any section of up to 1 in 66, and falling gradients of down to 1 in 40, are acceptable.
- (15) Crossbars. The crossbar lights shall be so arranged as to lie on a straight line passing through the associated centre line lights, and wherever possible this line shall be horizontal. It is permissible, however, to mount the lights on a transverse gradient not more than 1 in 80, if this enables crossbar lights within a stopway or clearway to be mounted nearer to the ground on sites where there is a cross-fall.
- (16) An area, hereinafter referred to as the light plane, has been established for obstacle clearance purposes, and all lights of the system are in this plane. This plane is rectangular in shape and symmetrically located about the approach lighting system's

centre line. It starts at the threshold and extends 60 m beyond the approach end of the system, and is 120 m wide.

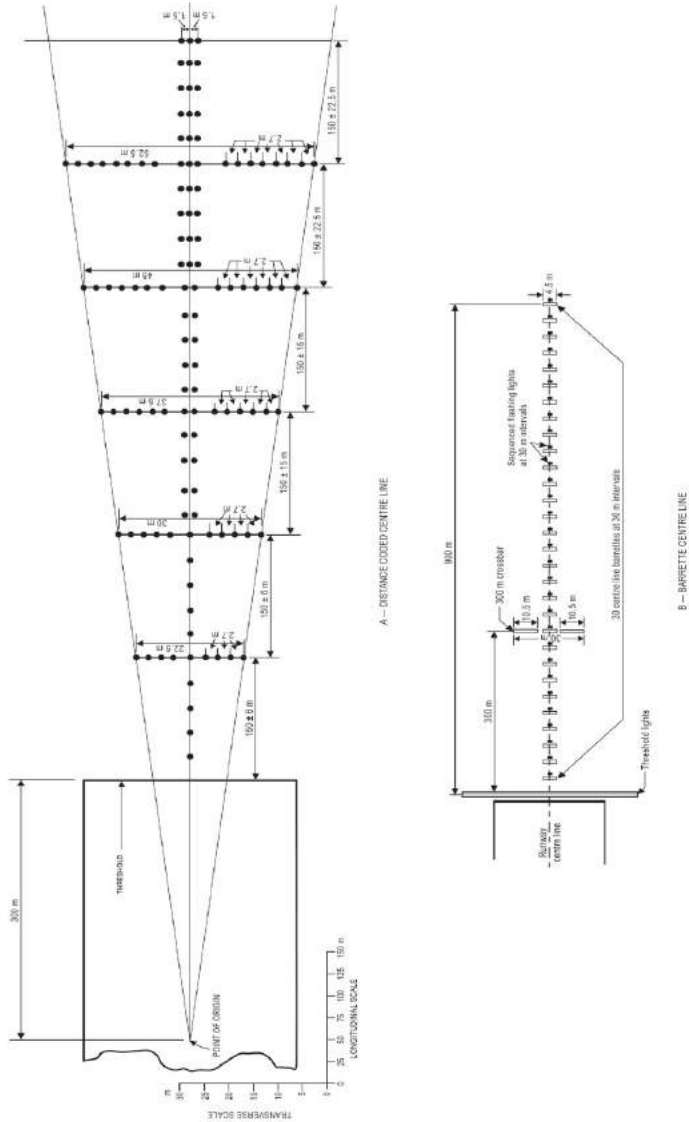
- (17) No objects are permitted to exist within the boundaries of the light plane which are higher than the light plane except as designated herein. All roads and highways are considered as obstacles extending 4.8 m above the crown of the road, except aerodrome service roads where all vehicular traffic is under control of the aerodrome authorities and coordinated with the aerodrome traffic control tower. Railroads, regardless of the amount of traffic, are considered as obstacles extending 5.4 m above the top of the rails.
- (18) It is recognised that some components of electronic landing aids systems, such as reflectors, antennas, monitors, etc., must be installed above the light plane. Every effort shall be made to relocate such components outside the boundaries of the light plane. In the case of reflectors and monitors, this can be done in many instances.
- (19) Where an ILS localizer is installed within the light plane boundaries, it is recognised that the localizer, or screen if used, must extend above the light plane. In such cases the height of these structures shall be held to a minimum and they shall be located as far from the threshold as possible. In general the rule regarding permissible heights is 15 cm for each 30 m the structure is located from the threshold. As an example, if the localizer is located 300 m from the threshold, the screen will be permitted to extend above the plane of the approach lighting system by  $10 \times 15 = 150$  cm maximum, but preferably shall be kept as low as possible consistent with proper operation of the ILS.
- (20) Objects existing within the boundaries of the light plane, requiring the light plane to be raised in order to meet the criteria contained herein, shall be removed, lowered or relocated where this can be accomplished more economically than raising the light plane.
- (21) In some instances objects may exist which cannot be removed, lowered or relocated economically. These objects may be

located so close to the threshold that they cannot be cleared by the 2 per cent slope. Where such conditions exist and no alternative is possible, the 2 per cent slope may be exceeded or a “stair step” resorted to in order to keep the approach lights above the objects. Such “step” or increased gradients shall be resorted to only when it is impracticable to follow standard slope criteria, and they shall be held to the absolute minimum. Under this criterion no negative slope is permitted in the outermost portion of the system.

- (22) The need for an adequate approach lighting system to support precision approaches where the pilot is required to acquire visual references prior to landing cannot be stressed too strongly. The safety and regularity of such operations is dependent on this visual acquisition. The height above runway threshold at which the pilot decides there are sufficient visual cues to continue the precision approach and land will vary, depending on the type of approach being conducted and other factors such as meteorological conditions, ground and airborne equipment, etc. The required length of approach lighting system which will support all the variations of such approaches is 900 m, and this shall always be provided whenever possible.
- (23) However, there are some runway locations where it is impossible to provide the 900 m length of approach lighting system to support precision approaches.
- (24) In such cases, every effort shall be made to provide as much approach lighting system as possible. The appropriate authority may impose restrictions on operations to runways equipped with reduced lengths of lighting. There are many factors which determine at what height the pilot must have decided to continue the approach to land or execute a missed approach. It must be understood that the pilot does not make an instantaneous judgement upon reaching a specified height.
- (25) The actual decision to continue the approach and landing sequence is an accumulative process which is only concluded at the specified height. Unless lights are available prior to reaching the decision point, the visual assessment process is impaired and the likelihood of missed approaches will increase substantially.

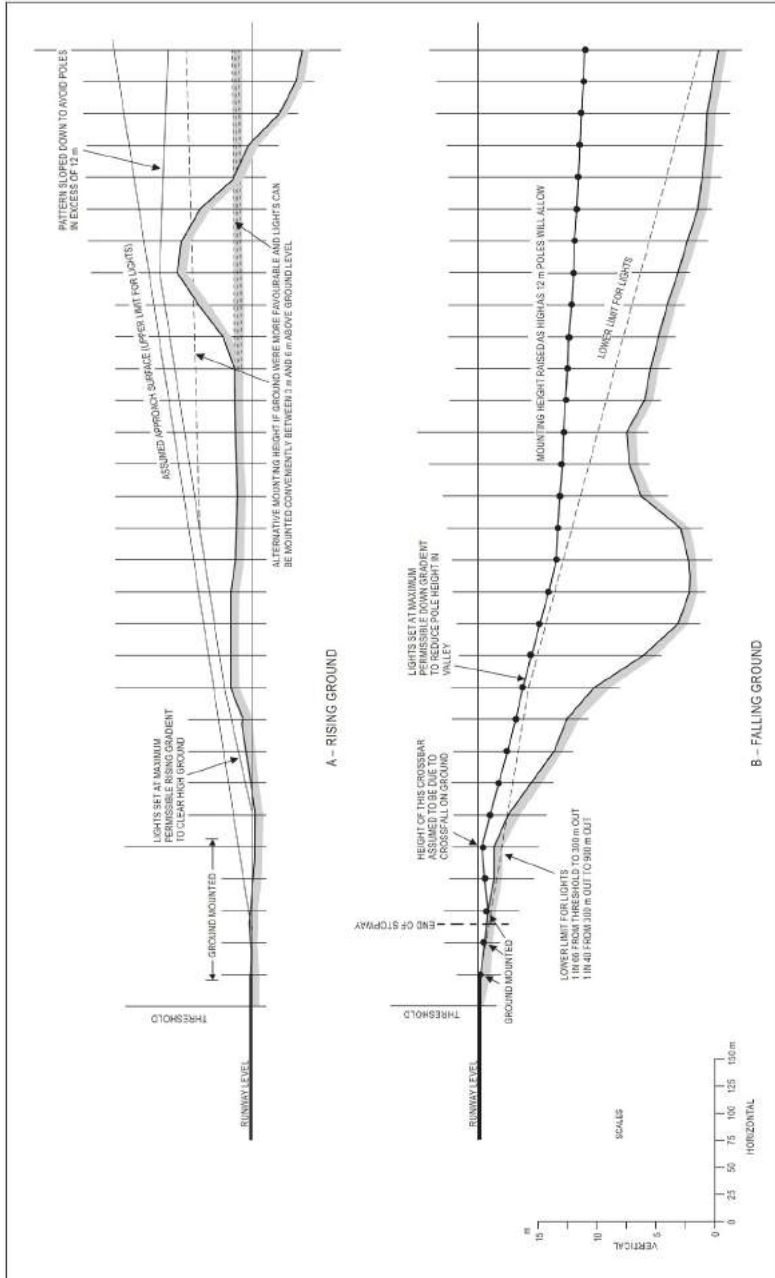
There are many operational considerations which must be taken into account by the appropriate authorities in deciding if any restrictions are necessary to any precision approach and these are detailed in Civil Aviation flight operations related Regulations.

**Figure S8-7. Precision approach category I lighting systems**





**Figure S8-8. Vertical installation tolerance**



## 12. **Priority of installation of visual approach slope indicator systems**

- (1) It has been found impracticable to develop guidance material that will permit a completely objective analysis to be made of which runway on an aerodrome shall receive first priority for the installation of a visual approach slope indicator system. However, factors that must be considered when making such a decision are:
  - (a) frequency of use;
  - (b) seriousness of the hazard;
  - (c) presence of other visual and non-visual aids;
  - (d) type of aeroplanes using the runway; and
  - (e) frequency and type of adverse weather conditions under which the runway will be used.
  
- (2) With respect to the seriousness of the hazard, the order given in the application specifications for a visual approach slope indicator system, may be used as a general guide. These may be summarised as—
  - (a) inadequate visual guidance because of:
    - (i) approaches over water or featureless terrain, or absence of sufficient extraneous light in the approach area by night;
    - (ii) deceptive surrounding terrain;
  - (b) serious hazard in approach;
  - (c) serious hazard if aeroplanes undershoot or overrun; and
  - (d) unusual turbulence.
  
- (3) The presence of other visual or non-visual aids is a very important factor. Runways equipped with ILS would generally receive the lowest priority for a visual approach slope indicator system installation. It must be remembered, though, that visual

approach slope indicator systems are visual approach aids in their own right and can supplement electronic aids. When serious hazards exist and/or a substantial number of aeroplanes not equipped for ILS use a runway, priority might be given to installing a visual approach slope indicator on this runway.

- (4) Priority shall be given to runways used by turbojet aeroplanes.

### 13. **Lighting of unserviceable areas**

- (1) Where a temporarily unserviceable area exists, it may be marked with fixed-red lights.
- (2) These lights shall mark the most potentially dangerous extremities of the area.
- (3) A minimum of four such lights shall be used, except where the area is triangular in shape where a minimum of three lights may be employed.
- (4) The number of lights shall be increased when the area is large or of unusual configuration.
- (5) At least one light shall be installed for each 7.5 m of peripheral distance of the area. If the lights are directional, they shall be orientated so that as far as possible their beams are aligned in the direction from which aircraft or vehicles will approach.
- (6) Where aircraft or vehicles will normally approach from several directions, consideration shall be given to adding extra lights or using omnidirectional lights to show the area from these directions.
- (7) Unserviceable area lights shall be frangible. Their height shall be sufficiently low to preserve clearance for propellers and for engine pods of jet aircraft.

### 14. **Rapid exit taxiway indicator lights**

- (1) Rapid exit taxiway indicator lights (RETILs) comprise a set of yellow unidirectional lights installed in the runway adjacent to the centre line. The lights are positioned in a 3-2-1 sequence at

100 m intervals prior to the point of tangency of the rapid exit taxiway centre line. They are intended to give an indication to pilots of the location of the next available rapid exit taxiway.

- (2) In low visibility conditions, RETILs provide useful situational awareness cues while allowing the pilot to concentrate on keeping the aircraft on the runway centre line.
- (3) Following a landing, runway occupancy time has a significant effect on achievable runway capacity. RETILs allow pilots to maintain a good roll-out speed until it is necessary to decelerate to an appropriate speed for the turn into a rapid exit turn-off. A roll-out speed of 60 knots until the first RETIL (three-light barrette) is reached is seen as the optimum.

#### 15. **Intensity control of approach and runway lights**

- (1) The conspicuity of a light depends on the impression received of contrast between the light and its background. If a light is to be useful to a pilot by day when on approach, it must have an intensity of at least 2000 or 3000 cd, and in the case of approach lights an intensity of the order of 20 000 cd is desirable. In conditions of very bright daylight fog it may not be possible to provide lights of sufficient intensity to be effective. On the other hand, in clear weather on a dark night, an intensity of the order of 100 cd for approach lights and 50 cd for the runway edge lights may be found suitable. Even then, owing to the closer range at which they are viewed, pilots have sometimes complained that the runway edge lights seemed unduly bright.
- (2) In fog the amount of light scattered is high. At night this scattered light increases the brightness of the fog over the approach area and runway to the extent that little increase in the visual range of the lights can be obtained by increasing their intensity beyond 2 000 or 3 000 cd. In an endeavor to increase the range at which lights would first be sighted at night, their intensity must not be raised to an extent that a pilot might find excessively dazzling at diminished range.
- (3) From the foregoing will be evident the importance of adjusting the intensity of the lights of an aerodrome lighting system

according to the prevailing conditions, so as to obtain the best results without excessive dazzle that would disconcert the pilot. The appropriate intensity setting on any particular occasion will depend both on the conditions of background brightness and the visibility.

## 16. **Signal area**

- (1) A signal area need be provided only when it is intended to use visual ground signals to communicate with aircraft in flight. Such signals may be needed when the aerodrome does not have an aerodrome control tower or an aerodrome flight information service unit, or when the aerodrome is used by aeroplanes not equipped with radio.
- (2) Visual ground signals may also be useful in the case of failure of two-way radio communication with aircraft. It shall be recognised, however, that the type of information which may be conveyed by visual ground signals shall normally be available in AIPs or NOTAM. The potential need for visual ground signals shall therefore be evaluated before deciding to provide a signal area.

## 17. **Rescue and fire-fighting services**

- (1) The rescue and fire-fighting service at an aerodrome shall be under the administrative control of the aerodrome management, which shall also be responsible for ensuring that the service provided is organised, equipped, staffed, trained and operated in such a manner as to fulfil its proper functions.
- (2) In drawing up the detailed plan for the conduct of search and rescue operations in accordance with the Civil Aviation (Search and Rescue) Regulations, 2020, the aerodrome management shall coordinate its plans with the relevant rescue coordination centres to ensure that the respective limits of their responsibilities for an aircraft accident within the vicinity of an aerodrome are clearly delineated.
- (3) Coordination between the rescue and fire-fighting service at an aerodrome and public protective agencies, such as local

fire brigade, police force, coast guard and hospitals, shall be achieved by prior agreement for assistance in dealing with an aircraft accident.

- (4) A grid map of the aerodrome and its immediate vicinity shall be provided for the use of the aerodrome services concerned. Information concerning topography, access roads and location of water supplies shall be indicated. This map shall be conspicuously posted in the control tower and fire station, and available on the rescue and fire-fighting vehicles and such other supporting vehicles required to respond to an aircraft accident or incident. Copies shall also be distributed to public protective agencies as desirable.
- (5) Coordinated instructions shall be drawn up detailing the responsibilities of all concerned and the action to be taken in dealing with emergencies. The appropriate authority shall ensure that such instructions are promulgated and observed.
- (6) The training curriculum shall include initial and recurrent instruction in at least the following areas—
  - (a) airport familiarisation ;
  - (b) aircraft familiarisation ;
  - (c) rescue and fire-fighting personnel safety;
  - (d) emergency communications systems on the aerodrome, including aircraft fire-related alarms;
  - (e) use of the fire hoses, nozzles, turrets and other appliances required for compliance with regulations 247 to 258;
  - (f) application of the types of extinguishing agents required for compliance with Regulations 247 to 258;
  - (g) emergency aircraft evacuation assistance;
  - (h) fire-fighting operations;
  - (i) adaptation and use of structural rescue and fire-fighting equipment for aircraft rescue and firefighting;
  - (j) dangerous goods;

- (k) familiarization with firefighters' duties under the aerodrome emergency plan; and
  - (l) protective clothing and respiratory protection.
- 
- (7) In accordance with regulations 247 to 258, aerodromes shall be categorised for rescue and fire-fighting purposes and the level of protection provided shall be appropriate to the aerodrome category.
  - (8) However, Regulation 249 permits a lower level of protection to be provided for a limited period where the number of movements of the aeroplanes in the highest category normally using the aerodrome is less than 700 in the busiest consecutive three months.
  - (9) It is important to note that the concession included in Regulation 249 is applicable only where there is a wide range of difference between the dimensions of the aeroplanes included in reaching 700 movements.
  - (10) Suitable rescue equipment and services shall be available at an aerodrome where the area to be covered by the service includes water, swampy areas or other difficult environment that cannot be fully served by conventional wheeled vehicles. This is particularly important where a significant portion of approach/ departure operations takes place over these areas.
  - (11) The rescue equipment shall be carried on boats or other vehicles such as helicopters and amphibious or air cushion vehicles, capable of operating in the area concerned. The vehicles shall be so located that they can be brought into action quickly to respond to the areas covered by the service.
  - (12) At an aerodrome bordering the water, the boats or other vehicles shall preferably be located on the aerodrome, and convenient launching or docking sites provided. If these vehicles are located off the aerodrome, they shall preferably be under the control of the aerodrome rescue and fire-fighting service or, if

this is not practicable, under the control of another competent public or private organisation working in close coordination with the aerodrome rescue and fire-fighting service such as police, military services and marine.

- (13) Boats or other vehicles shall have as high a speed as practicable so as to reach an accident site in minimum time. To reduce the possibility of injury during rescue operations, water jet-driven boats are preferred to water propeller-driven boats unless the propellers of the latter boats are ducted. Shall the water areas to be covered by the service be frozen for a significant period of the year, the equipment shall be selected accordingly. Vehicles used in this service shall be equipped with life rafts and life preservers related to the requirements of the larger aircraft normally using the aerodrome, with two-way radio communication, and with floodlights for night operations. If aircraft operations during periods of low visibility are expected, it may be necessary to provide guidance for the responding emergency vehicles.
- (14) The personnel designated to operate the equipment shall be adequately trained and drilled for rescue services in the appropriate environment.
- (15) The provision of special telephone, two-way radio communication and general alarm systems for the rescue and fire-fighting service is desirable to ensure the dependable transmission of essential emergency and routine information. Consistent with the individual requirements of each aerodrome, these facilities serve the following purposes—
  - (a) direct communication between the activating authority and the aerodrome fire station in order to ensure the prompt alerting and dispatch of rescue and fire-fighting vehicles and personnel in the event of an aircraft accident or incident;
  - (b) direct communication between the rescue and fire-fighting service and the flight crew of an aircraft in emergency;



- (c) emergency signals to ensure the immediate summoning of designated personnel not on standby duty;
  - (d) as necessary, summoning essential related services on or off the aerodrome; and
  - (e) maintaining communication by means of two-way radio with the rescue and fire-fighting vehicles in attendance at an aircraft accident or incident.
- (16) The availability of ambulance and medical facilities for the removal and after-care of casualties arising from an aircraft accident shall receive the careful consideration of the appropriate authority and shall form part of the overall emergency plan established to deal with such emergencies.

18. **Operators of vehicles**

- (1) The aerodrome operator shall ensure that the operators of vehicles on the movement area are properly qualified. This may include, as appropriate to the driver's function, knowledge of—
- (a) the geography of the aerodrome;
  - (b) aerodrome signs, markings and lights;
  - (c) radiotelephone operating procedures;
  - (d) terms and phrases used in aerodrome control including the ICAO spelling alphabet;
  - (e) rules of air traffic services as they relate to ground operations;
  - (f) airport rules and procedures; and
  - (g) specialist functions as required, for example, in rescue and firefighting.
- (2) The operator shall be able to demonstrate competency, as appropriate, in:
- (a) the operation or use of vehicle transmit/receive equipment;

- (b) understanding and complying with air traffic control and local procedures;
- (c) vehicle navigation on the aerodrome;
- (d) radio telephony techniques; and
- (e) special skills required for the particular function.

In addition, as required for any specialist function, the operator shall be the holder of a Uganda driver's licence.

- (3) The above shall be applied as is appropriate to the function to be performed by the operator, and it is not necessary that all operators be trained to the same level, for example, operators whose functions are restricted to the apron.
- (4) If special procedures apply for operations in low visibility conditions, it is desirable to verify an operator's knowledge of the procedures through periodic checks.

#### 19. **The ACN-PCN method of reporting pavement strength**

*Applicable until 27 November 2024*

- (1) Overloading of pavements can result either from loads too large, or from a substantially increased application rate, or both. Loads larger than the defined (design or evaluation) load shorten the design life, whilst smaller loads extend it.
- (2) With the exception of massive overloading, pavements in their structural behaviour are not subject to a particular limiting load above which they suddenly or catastrophically fail. Behavior is such that a pavement can sustain a definable load for an expected number of repetitions during its design life. As a result, occasional minor overloading is acceptable, when expedient, with only limited loss in pavement life expectancy and relatively small acceleration of pavement deterioration.
- (3) For those operations in which magnitude of overload or the frequency of use do not justify a detailed analysis, the following criteria are suggested:

- (a) for flexible pavements, occasional movements by aircraft with ACN not exceeding 10 per cent above the reported PCN shall not adversely affect the pavement;
  - (b) for rigid or composite pavements, in which a rigid pavement layer provides a primary element of the structure, occasional movements by aircraft with ACN not exceeding 5 per cent above the reported PCN shall not adversely affect the pavement;
  - (c) if the pavement structure is unknown, the 5 per cent limitation shall apply; and
  - (d) the annual number of overload movements shall not exceed approximately 5 per cent of the total annual aircraft movements.
- (4) Such overload movements shall not normally be permitted on pavements exhibiting signs of distress or failure. Furthermore, overloading shall be avoided during any periods when the strength of the pavement or its subgrade could be weakened by water.
- (5) Where overload operations are conducted, the appropriate authority shall review the relevant pavement condition regularly, and shall also review the criteria for overload operations periodically since excessive repetition of overloads can cause severe shortening of pavement life or require major rehabilitation of pavement.
- (6) For convenience, several aircraft types currently in use have been evaluated on rigid and flexible pavements founded on the four subgrade strength categories in Regulation 72 subregulation (7) b.

**20. The ACR-PCR method of reporting pavement strength**

*Applicable as of 28 November 2024*

- (1) Overloading of pavements can result either from loads too large, or from a substantially increased application rate, or both. Loads larger than the defined (design or evaluation) load shorten the design life, whilst smaller loads extend it.

- (2) With the exception of massive overloading, pavements in their structural behaviour are not subject to a particular limiting load above which they suddenly or catastrophically fail. Behaviour is such that a pavement can sustain a definable load for an expected number of repetitions during its design life. As a result, occasional minor overloading is acceptable, when expedient, with only limited loss of pavement life expectancy and relatively small acceleration of pavement deterioration.
- (3) For those operations in which magnitude of overload and/or the frequency of use do not justify a detailed analysis, the following criteria are suggested:
  - (a) for flexible and rigid pavements, occasional movements by aircraft with ACR not exceeding 10 per cent above the reported PCR should not adversely affect the pavement;
  - (b) the annual number of overload movements should not exceed approximately 5 per cent of the total annual aircraft movements, excluding light aircraft.
- (4) Such overload movements should not normally be permitted on pavement exhibiting signs of distress or failure.
- (5) Where overload operations are conducted, the appropriate authority should review the relevant pavement condition regularly, and should also review the criteria for overload operations periodically since excessive repetition of overloads can cause severe shortening of pavement life or require major rehabilitation of pavement.
- (6) For convenience, a dedicated software is available on the ICAO website, for computing any aircraft ACRs at any mass on rigid and flexible pavements for the four standard subgrade strength categories detailed in Regulation 73 (6) (b).

## 21. **Autonomous runway incursion warning system (ARIWS)**

Note — These autonomous systems are generally quite complex in design and operation and, as such, deserve careful consideration by all levels of the industry, from the regulating authority to the end user. This guidance

is offered to provide a more clear description of the system and offer some suggested actions required in order to properly implement these system at an aerodrome.

- (1) The operation of an ARIWS is based upon a surveillance system which monitors the actual situation on a runway and automatically returns this information to warning lights at the runway (take-off) thresholds and entrances. When an aircraft is departing from a runway (rolling) or arriving at a runway (short final), red warning lights at the entrances will illuminate, indicating that it is unsafe to enter or cross the runway. When an aircraft is aligned on the runway for take-off and another aircraft or vehicle enters or crosses the runway, red warning lights will illuminate at the threshold area, indicating that it is unsafe to start the take-off roll.
- (2) In general, an ARIWS consists of an independent surveillance system (primary radar, multilateration, specialised cameras, dedicated radar, etc.) and a warning system in the form of extra airfield lighting systems connected through a processor which generates alerts independent from ATC directly to the flight crews and vehicle operators.
- (3) An ARIWS does not require circuit interleaving, secondary power supply or operational connection to other visual aid systems.
- (4) In practice, not every entrance or threshold needs to be equipped with warning lights. Each aerodrome will have to assess its needs individually depending on the characteristics of the aerodrome. There are several systems developed offering the same or similar functionality.
- (5) It is of critical importance that flight crews understand the warning being transmitted by the ARIWS system. Warnings are provided in near real- time, directly to the flight crew because there is no time for “relay” types of communications. In other words, a conflict warning generated to ATS which must then interpret the warning, evaluate the situation and communicate to the aircraft in question, would result in several seconds being taken up where each second is critical in the ability to stop the aircraft safely and prevent a potential collision.

- (6) Pilots are presented with a globally consistent signal which means “STOP IMMEDIATELY” and must be taught to react accordingly. Likewise, pilots receiving an ATS clearance to take-off or cross a runway, and seeing the red light array, must STOP and advise ATS that they aborted/stopped because of the red lights. Again, the criticality of the timeline involved is so tight that there is no room for misinterpretation of the signal. It is of utmost importance that the visual signal be consistent around the world.
- (7) It must also be stressed that the extinguishing of the red lights does not, in itself, indicate a clearance to proceed. That clearance is still required from air traffic control. The absence of red warning lights only means that potential conflicts have not been detected.
- (8) In the event that a system becomes unserviceable, one of two things will occur. If the system fails in the extinguished condition, then no procedural changes need to be accomplished. The only thing that will happen is the loss of the automatic, independent warning system. Both ATS operations and flight crew procedures (in response to ATS clearances) will remain unchanged.
- (9) Procedures shall be developed to address the circumstance where the system fails in the illuminated condition. It will be up to the ATS and/ or aerodrome operator to establish those procedures depending on their own circumstances. It must be remembered that flight crews are instructed to “STOP” at all red lights. If the affected portion of the system, or the entire system, is shut off the situation is reverted to the extinguished scenario described in (8) above.
- (10) An ARIWS does not have to be provided at all aerodromes. An aerodrome considering the installation of such a system may wish to assess its needs individually, depending on traffic levels, aerodrome geometry, ground taxi patterns, etc.
- (11) Local user groups such as the Local Runway Safety Team (LRST) can be of assistance in this process. Also, not every runway or taxiway needs to be equipped with the lighting

array(s), and not every installation requires a comprehensive ground surveillance system to feed information to the conflict detection computer.

- (12) Although there may be local specific requirements, some basic system requirements are applicable to all ARIWS—
  - (a) the control system and energy power supply of the system must be independent from any other system in use at the aerodrome, especially the other parts of the lighting system;
  - (b) the system must operate independently from ATS communications;
  - (c) the system must provide a globally accepted visual signal that is consistent and instantly understood by crews; and
  - (d) local procedures shall be developed in the case of malfunction or failure of a portion of, or the entire system.
- (13) The ARIWS is designed to be complementary to normal ATS functions, providing warnings to flight crews and vehicle operators when some conflict has been unintentionally created or missed during normal aerodrome operations.
- (14) The ARIWS will provide a direct warning when, for example, ground control or tower (local) control has provided a clearance to hold short of a runway but the flight crew or vehicle operator has “missed” the hold short portion of their clearance and tower has issued a take-off or landing clearance to that same runway, and the non-read back by the flight crew or vehicle operator was missed by air traffic control.
- (15) In the case where a clearance has been issued and a crew reports a non-compliance due to “red lights”, or aborting because of “red lights”, then it is imperative that the controller assess the situation and provide additional instructions as necessary. It may well be that the system has generated a false warning or that the potential incursion no longer exists; however, it may also be a valid warning. In any case, additional instructions and/

or a new clearance need to be provided. In a case where the system has failed, then procedures will need to be put into place as described in (9) above and

- (16) In no case shall the illumination of the ARIWS be dismissed without confirmation that, in fact, there is no conflict. It is worth noting that there have been numerous incidents avoided at aerodromes with such systems installed. It is also worth noting that there have been false warnings as well, usually as a result of the calibration of the warning software, but in any case, the potential conflict existence or non-existence must be confirmed.
- (17) While many installations may have a visual or audio warning available to ATS personnel, it is in no way intended that ATS personnel be required to actively monitor the system. Such warnings may assist ATS personnel in quickly assessing the conflict in the event of a warning and help them to provide appropriate further instructions, but the ARIWS shall not play an active part in the normal functioning of any ATS facility.
- (18) Each aerodrome where the system is installed will develop procedures depending upon its unique situation. Again, it must be stressed that under no circumstances shall pilots or operators be instructed to “cross the red lights”. As indicated previously, the use of local runway safety teams can greatly assist in this development process.
- (19) Information on the characteristics and status of an ARIWS at an aerodrome are promulgated in the AIP section AD 2.9, and its status updated as necessary through NOTAM or ATIS in compliance with Regulation 76 (1).
- (20) Aircraft operators are to ensure that flight crews’ documentation include procedures regarding ARIWS and appropriate guidance information, in compliance with Civil Aviation (Operation of Aircraft-Commercial Air Transport) Regulations 2022.
- (21) Aerodromes may provide additional sources of guidance on operations and procedures for their personnel, aircraft operators, ATS and third-party personnel who may have to deal with an ARIWS.



## 22. **Taxiway design guidance for minimising the potential for runway incursions**

- (1) Good aerodrome design practices can reduce the potential for runway incursions while maintaining operating efficiency and capacity. The following taxiway design guidance may be considered to be part of a runway incursion prevention programme as a means to ensure that runway incursion aspects are addressed during the design phase for new runways and taxiways. Within this focused guidance, the prime considerations are to limit the number of aircraft or vehicles entering or crossing a runway, provide pilots with enhanced unobstructed views of the entire runway, and correct taxiways identified as hot spots as much as possible.
- (2) The centre line of an entrance taxiway shall be perpendicular to the runway centre line, where possible. This design principle provides pilots with an unobstructed view of the entire runway, in both directions, to confirm that the runway and approach are clear of conflicting traffic before proceeding towards the runway. Where the taxiway angle is such that a clear unobstructed view, in both directions, is not possible, consideration shall be given to providing a perpendicular portion of the taxiway immediately adjacent to the runway to allow for a full visual scan by the pilots prior to entering or crossing a runway.
- (3) For taxiways intersecting with runways, avoid designing taxiways wider than recommended in this Annex. This design principle offers improved recognition of the location of the runway holding position and the accompanying sign, marking and lighting visual cues.
- (4) Existing taxiways wider than recommended in this Annex, can be rectified by painting taxi side stripe markings to the recommended width. As far as practicable, it is preferable to redesign such locations properly rather than to repaint such locations.
- (5) Multi-taxiway entrances to a runway shall be parallel to each other and shall be distinctly separated by an unpaved area.

This design principle allows each runway holding location an earthen area for the proper placement of accompanying sign, marking and lighting visual cues at each runway holding position. Moreover, the design principle eliminates the needless costs of building unusable pavement and as well as the costs for painting taxiway edge markings to indicate such unusable pavement. In general, excess paved areas at runway holding positions reduce the effectiveness of sign, marking and lighting visual cues.

- (6) Build taxiways that cross a runway as a single straight taxiway. Avoid dividing the taxiway into two after crossing the runway. This design principle avoids constructing “Y-shaped” taxiways known to present risk of runway incursions.
- (7) If possible, avoid building taxiways that enter at the mid-runway location. This design principle helps to reduce the collision risks at the most hazardous locations (high energy location) because normally departing aircraft have too much energy to stop, but not enough speed to take-off, before colliding with another errant aircraft or vehicle.
- (8) Provide clear separation of pavement between a rapid exit taxiway and other non-rapid taxiways entering or crossing a runway. This design principle avoids two taxiways from overlapping each other to create an excessive paved area that would confuse pilots entering a runway.
- (9) Avoid the placement of different pavement materials (asphalt and cement concrete) at or near the vicinity of the runway holding position, as far as practicable. This design principle avoids creating visual confusion as to the actual location of the runway holding position.
- (10) Many aerodromes have more than one runway, notably paired parallel runways (two runways on one side of the terminal), which creates a difficult problem in that either on arrival or departure an aircraft is required to cross a runway. Under such a configuration, the safety objective here is to avoid or at least keep to a minimum the number of runway crossings. This

safety objective may be achieved by constructing a “perimeter taxiway”.

- (11) A perimeter taxiway is a taxi route that goes around the end of a runway, enabling arrival aircraft (when landings are on outer runway of a pair) to get to the terminal, or departure aircraft (when departures are on outer runway of a pair) to get to the runway, without either crossing a runway or conflicting with a departing or approaching aircraft.
- (12) A perimeter taxiway would be designed according to the following criteria —
  - (a) sufficient space is required between the landing threshold and the taxiway centre line where it crosses under the approach path to enable the critical taxiing aircraft to pass under the approach without penetrating any approach surface;
  - (b) the jet blast impact of aircraft taking off shall be considered in consultation with aircraft manufacturers; the extent of take-off thrust shall be evaluated when determining the location of a perimeter taxiway;
  - (c) the requirement for a runway end safety area, as well as possible interference with landing systems and other navigation aids shall also be taken into account. For example, in the case of an ILS, the perimeter taxiway shall be located behind the localiser antenna, not between the localiser antenna and the runway, due to the potential for severe ILS disturbance, noting that this is harder to achieve as the distance between the localizer and the runway increases;
  - (d) human factors issues shall also be taken into account. Appropriate measures shall be put in place to assist pilots to distinguish between aircraft that are crossing the runway and those that are safely on a perimeter taxiway.

## 23. **Aerodrome mapping data**

- (1) Regulation 67 (2) and (3), relate to the provision of aerodrome mapping data. The aerodrome mapping data features are collected and made available to the aeronautical information services for aerodromes designated by authority with consideration of the intended applications. These applications are closely tied to an identified need and operational use where the application of the data would provide a safety benefit or could be used as mitigation of a safety concern.
- (2) Aerodrome mapping data include aerodrome geographic information that supports applications which improve the user's situational awareness or supplement surface navigation, thereby increasing safety margins and operational efficiency. With appropriate data element accuracy, these data sets support collaborative decision-making, common situational awareness and aerodrome guidance applications. The data sets are intended to be used in the following air navigation applications—
  - (a) on-board positioning and route awareness including moving maps with own aircraft position, surface guidance and navigation;
  - (b) traffic awareness including surveillance and runway incursion detection and alerting (such as, respectively, in A-SMGCS levels 1 and 2);
  - (c) ground positioning and route awareness including situational displays with aircraft and vehicles position and taxi route, surface guidance and navigation (such as A-SMGCS levels 3 and 4);
  - (d) facilitation of aerodrome-related aeronautical information, including NOTAMs;
  - (e) resource and aerodrome facility management; and
  - (f) aeronautical chart production.
- (3) The data may also be used in other applications such as training/flight simulators and on-board or ground enhanced vision

systems (EVS), synthetic vision systems (SVS) and combined vision systems (CVS).

- (4) Determination of aerodromes to be considered for collection of aerodrome mapping data features.
- (5) In order to determine which aerodromes may make use of applications requiring the collection of aerodrome mapping data features, the following aerodrome characteristics may be considered—
  - (a) safety risks at the aerodrome;
  - (b) visibility conditions;
  - (c) aerodrome layout; and
  - (d) traffic density.

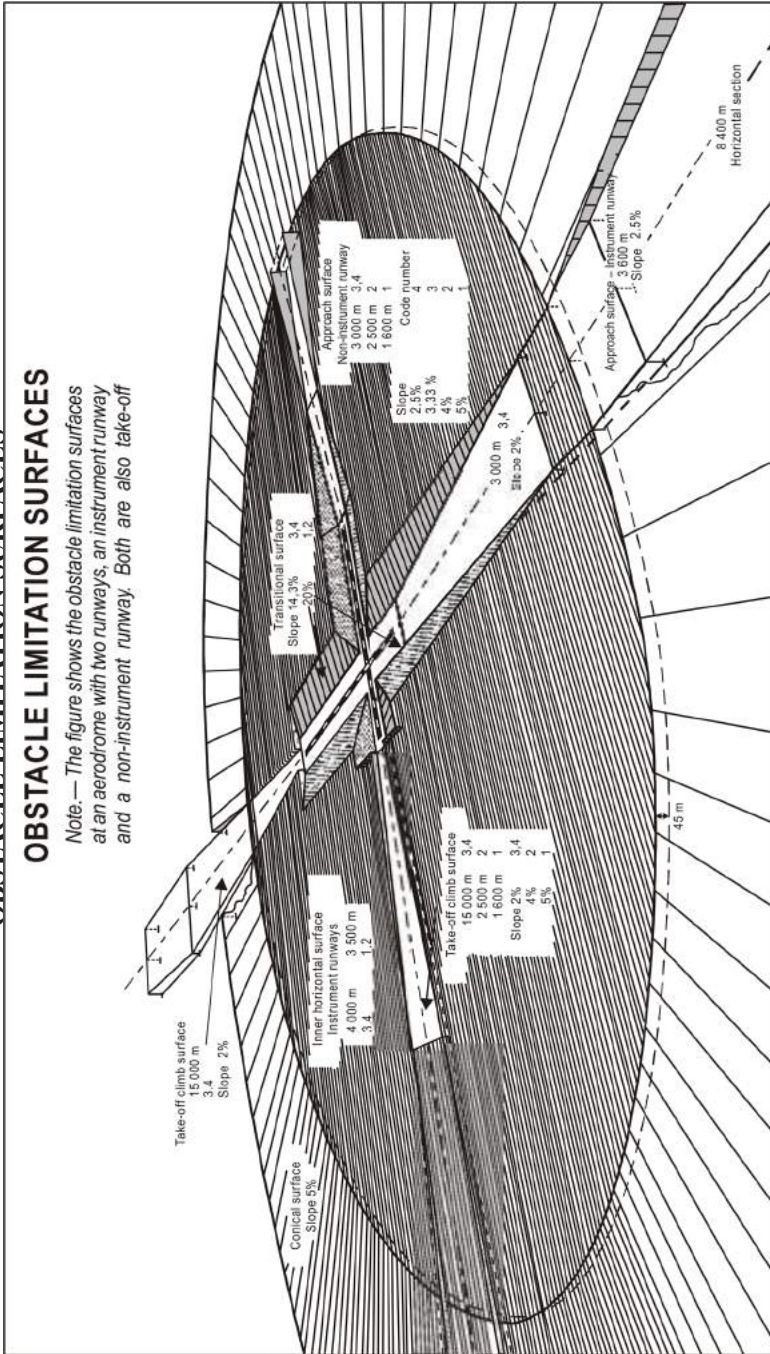
# SCHEDULE 9

Part IX

## OBSTACLE LIMITATION SURFACES

### OBSTACLE LIMITATION SURFACES

Note.—The figure shows the obstacle limitation surfaces at an aerodrome with two runways, an instrument runway and a non-instrument runway. Both are also take-off



GEN. EDWARD KATUMBA-WAMALA  
*Minister of Works and Transport*

## **CROSS REFERENCES**

Civil Aviation (Operator of Aircraft) Regulations, 2022

Civil Aviation (Aeronautical Information Services) Regulations, 2022

Civil Aviation (Security) Regulations, 2022

Civil Aviation (Safety Management) Regulations, 2022

Civil Aviation (Aircraft Accident and Incident Investigation) Regulations, 2022.

Civil Aviation (Search and Rescue) Regulations 2020

Civil Aviation (Aeronautical Radio Navigation Aids) Regulations, 2022

Civil Aviation (Operation of Aircraft) Regulations 2022